

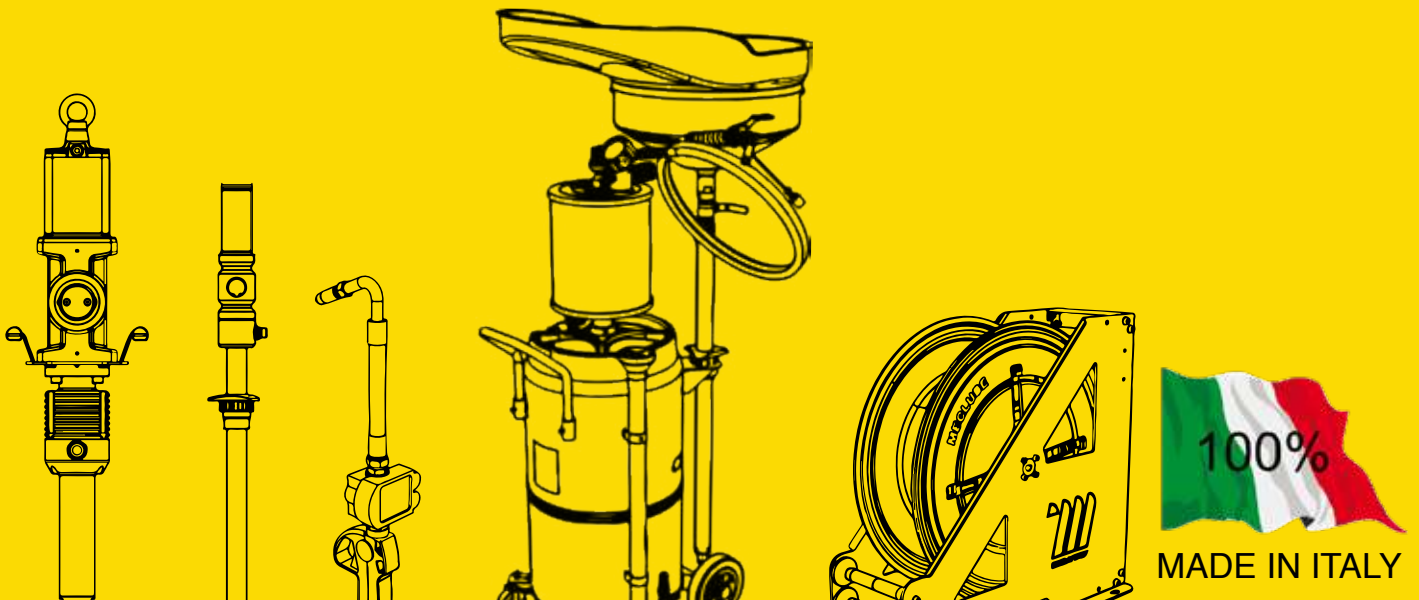

[www.meclube.com](http://www.meclube.com)

# LUBRICATION EQUIPMENT



Catalogue 02/2024



## Company

MECLUBE is an industrial company that manufactures lubrication equipment for every specific requirement, giving best collaboration to the customers and working to grow with them. MECLUBE is a young and dynamic company, but it has already all the know-how and the experience of qualified personnel, and its main targets are the service to the customer (especially the post-sale assistance) and the quality: it is already operating with the necessary quality standards to achieve the ISO 9001:2015 certification. MECLUBE is a constantly developing company: new products are in project to improve and facilitate the work in the automotive garages.

## Service

Our company is able to offer to all our customers items of high quality and availability. It has a modern and innovative equipment of project, a lot of machines with a huge productive potential, a wide range of stamps, manufacturing cycles, tools, test and assembly machinery. Our customers represent the most important patrimony of MECLUBE. We are convinced that people make the difference, and we are at their disposal to start a relationship of growth and innovation, always having in mind the only possible result: the best one.

## Test room





### **Fully Italian production**

MECLUBE gives to all its customers the availability of a global service, assured by a wide range of products. The excellent relation between quality/price and the respect of the delivery time make our company an ideal partner. Thanks to the high flexibility of our modalities of production we are able to establish an exceptional relation with our customers that comes true in the customization, in the colour, in the brand of the company on the standard range of our products. Our purchase cycle becomes complete with a speedy and qualified assistance service.





**GREASE DISTRIBUTION**

**page 3**



**OIL DISTRIBUTION**

**page 63**



**ANTI-FREEZE WINDSCREEN LIQUID DISTRIBUTION** page 165



**BRAKE BLEEDERS**

**page 173**



**AIR-OPERATED DOUBLE DIAPHRAGM PUMPS** page 181



**TROLLEYS FOR DRUMS**

**page 225**



**EXHAUSTED OIL ASPIRATORS**

**page 231**



**EXHAUSTED OIL DRAIN UNITS**

**page 249**



**PRESSURE SPRAYERS - WASHING**

**page 259**



**TYRE INFLATORS**

**page 271**



**HOSE REELS**

**page 277**

# GREASE DISTRIBUTION





The new **patented** air-operated grease pumps, fully designed and manufactured by MECLUBE, show remarkable operating features. They are fully made with electronic machine tools, the assembly is made with great care and the parts have been carefully tested in order to assure the best guarantee of reliability and a long life. The choice of materials and manufacturing quality make these pumps suitable to work in the worst environmental conditions.

- **Brand new fully air-operated motion reverse device, without cams and springs**
- **Reduced number of wearing parts**
- **Big quantity of grease supplied at low air consumption**
- **High operating pressure**
- **Aluminum alloy body pump with electrolytic treatment that ensures very high corrosion strength**
- **High stressed elements in Fe 420 steel**



	<p>AIR-OPERATED GREASE PUMPS</p>	<p>page 4</p>
	<p>AIR-OPERATED GREASE PUMP AND TRANSFER KITS</p>	<p>page 9</p>
	<p>AIR-OPERATED GREASE SPRAYER KITS</p>	<p>page 20</p>
	<p>ACCESSORIES FOR AIR-OPERATED PUMPS</p>	<p>page 23</p>
	<p>NOZZLES FOR GREASE PUMPS</p>	<p>page 24</p>
	<p>ACCESSORIES AND COUPLERS FOR GREASE PUMPS</p>	<p>page 28</p>
	<p>AIR-OPERATED INDUSTRIAL GREASE PUMPS</p>	<p>page 30</p>
	<p>ACCESSORIES FOR INDUSTRIAL GREASE PUMPS</p>	<p>page 42</p>
	<p>PRESSURE REGULATORS AND AIR CONNECTIONS</p>	<p>page 45</p>
	<p>MANUAL, BATTERY GREASE PUMPS AND ACCESSORIES</p>	<p>page 47</p>
	<p>HIGH PRESSURE MANUAL PUMPS TO GREASE AND FOR GREASE TRANSFER</p>	<p>page 56</p>



# AIR-OPERATED GREASE PUMPS Mod. 660

**COMPRESSION RATIO = 60:1**

**DELIVERY = 1600 g/min**



## Art. 010-1000-000

**Air-operated grease pump R=60:1 Mod. 660**

For standard drums **12-16 kg**

(shank length 410 mm)

**Polyurethane seals**

## Art. 010-1005-000

**Air-operated grease pump R=60:1 Mod. 660**

For standard drums **18-30 kg**

(shank length 480 mm)

**Polyurethane seals**

## Art. 010-1010-000

**Air-operated grease pump R=60:1 Mod. 660**

For standard drums **50-60 kg**

(shank length 750 mm)

**Polyurethane seals**

## Art. 010-1015-000

**Air-operated grease pump R=60:1 Mod. 660**

For standard drums **180-220 kg**

(shank length 950 mm)

**Polyurethane seals**



<b>010-1000-000</b>	4,980	0,010	1
<b>010-1005-000</b>	4,900	0,010	1
<b>010-1010-000</b>	6,000	0,013	1
<b>010-1015-000</b>	6,900	0,016	1

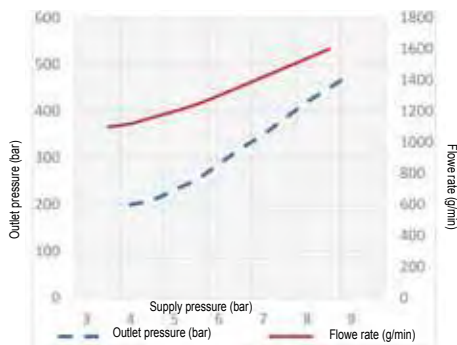
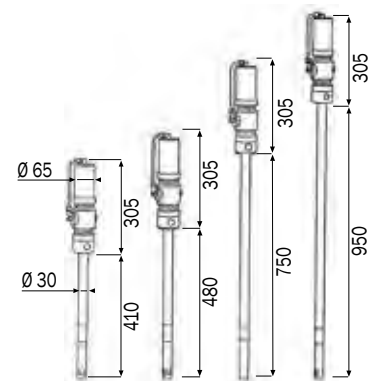

(GREASE NLGI 1 20° C)

Technical data		010-1000-000	010-1005-000	010-1010-000	010-1015-000
Compression ratio		60:1	60:1	60:1	60:1
Max pressure supply	bar	8	8	8	8
Medium air consumption	l/min	130	130	130	130
Air inlet connection	BSP	F 1/4" G	F 1/4" G	F 1/4" G	F 1/4" G
Grease outlet connection	BSP	M 1/4" G	M 1/4" G	M 1/4" G	M 1/4" G
Grease delivery capacity 8 barg/min		1600	1600	1600	1600
Noise	dB	76	76	76	76
Shank diameter	mm	30	30	30	30
Shank length	mm	410	480	750	950
For drums with capacity of	kg	12-16	18-30	50-60	180-220

These pumps are suitable for the supply at high pressure of greases with viscosity up to NLGI 2 at short and long distances. The operating pressure of the grease pumps hereby may vary between a minimum of 2.5 bar and a maximum of 8 bar. In order to optimize the efficiency and the life of our air-operated pumps, we recommend to use filtered and lubricated air.

# AIR-OPERATED GREASE PUMPS Mod. 670

**COMPRESSION RATIO = 70:1**

**DELIVERY = 1100 g/min**



## Art. 010-1018-000

**Air-operated grease pump R=70:1 Mod. 670**

For standard drums **12-16 kg**

(shank length 410 mm)

**Polyurethane seals**

## Art. 010-1020-000

**Air-operated grease pump R=70:1 Mod. 670**

For standard drums **18-30 kg**

(shank length 480 mm)

**Polyurethane seals**

## Art. 010-1025-000

**Air-operated grease pump R=70:1 Mod. 670**

For standard drums **50-60 kg**

(shank length 750 mm)

**Polyurethane seals**

## Art. 010-1030-000

**Air-operated grease pump R=70:1 Mod. 670**

For standard drums **180-220 kg**

(shank length 950 mm)

**Polyurethane seals**

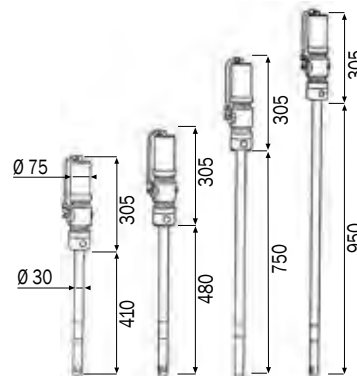

Art. No.	Weight (Kg)	Volume (m³)	NLGI
010-1018-000	5,400	0,010	1
010-1020-000	5,600	0,010	1
010-1025-000	6,800	0,013	1
010-1030-000	7,000	0,016	1

Technical data		010-1018-000	010-1020-000	010-1025-000	010-1030-000
Compression ratio		70:1	70:1	70:1	70:1
Max pressure supply	bar	8	8	8	8
Medium air consumption	l/min	150	150	150	150
Air inlet connection	BSP	F 1/4" G	F 1/4" G	F 1/4" G	F 1/4" G
Grease outlet connection	BSP	M 1/4" G	M 1/4" G	M 1/4" G	M 1/4" G
Grease delivery capacity 8 bar g/min		1100	1100	1100	1100
Noise	dB	76	76	76	76
Shank diameter	mm	30	30	30	30
Shank length	mm	410	480	750	950
For drums with capacity of	kg	12-16	18-30	50-60	180-220

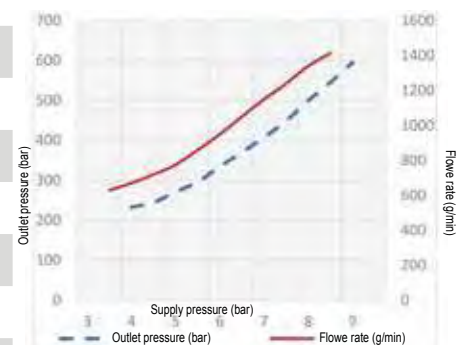

(GREASE NLGI 1 20° C)

These pumps are suitable for the supply at high pressure of greases with viscosity up to NLGI 2 at short and long distances. The operating pressure of the grease pumps hereby may vary between a minimum of 2.5 bar and a maximum of 8 bar. In order to optimize the efficiency and the life of our air-operated pumps, we recommend to use filtered and lubricated air.

# AIR-OPERATED GREASE PUMPS Mod. 700

**COMPRESSION RATIO = 100:1**

**DELIVERY = 1000 g/min**

## Art. 010-1032-000

Air-operated grease pump R=100:1 Mod. 700

For standard drums **18-30 kg**

(shank length 480 mm)

**Polyurethane seals**

## Art. 010-1034-000

Air-operated grease pump R=100:1 Mod. 700

For standard drums **50-60 kg**

(shank length 750 mm)

**Polyurethane seals**

## Art. 010-1035-000

Air-operated grease pump R=100:1 Mod. 700

For standard drums **180-220 kg**

(shank length 950 mm)

**Polyurethane seals**

010-1032-000

010-1034-000

010-1035-000



010-1032-000	5,300	0,010	1
010-1034-000	6,400	0,013	1
010-1035-000	7,200	0,016	1

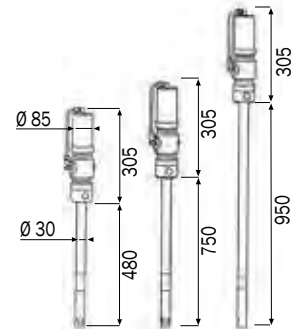

Technical data		010-1032-000	010-1034-000	010-1035-000
Compression ratio		100:1	100:1	100:1
Max pressure supply	bar	8	8	8
Medium air consumption	l/min	190	190	190
Air inlet connection	BSP	F 1/4" G	F 1/4" G	F 1/4" G
Grease outlet connection	BSP	M 1/4" G	M 1/4" G	M 1/4" G
Grease delivery capacity 8 bar	g/min	1000	1000	1000
Noise	dB	79	79	79
Shank diameter	mm	30	30	30
Shank length	mm	480	750	950
For drums with capacity of	kg	18-30	50-60	180-220

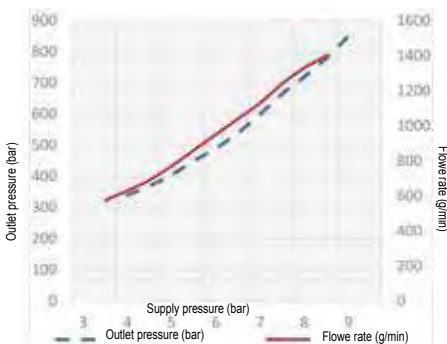

(GREASE NLGI 1 20° C)

These pumps are suitable for the supply at high pressure of greases with viscosity up to NLGI 2 at short and long distances. The operating pressure of the grease pumps hereby may vary between a minimum of 2.5 bar and a maximum of 8 bar. In order to optimize the efficiency and the life of our air-operated pumps, we recommend to use filtered and lubricated air.

# AIR-OPERATED TRANSFER GREASE PUMPS Mod. 614

**COMPRESSION RATIO = 14:1**

**DELIVERY = 2000 g/min**



## Art. 010-1036-000

**Air-operated grease pump R=14:1 Mod. 614**

For standard drums **18-30 kg**

(shank length 480 mm)

**Polyurethane seals**

## Art. 010-1038-000

**Air-operated grease pump R=14:1 Mod. 614**

For standard drums **50-60 kg**

(shank length 740 mm)

**Polyurethane seals**

## Art. 010-1040-000

**Air-operated grease pump R=14:1 Mod. 614**

For standard drums **180-220 kg**

(shank length 940 mm)

**Polyurethane seals**

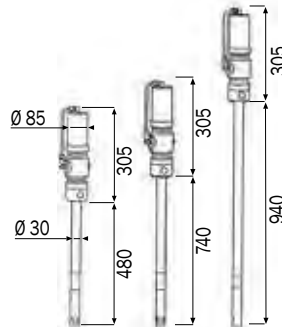

Art. No.	Weight (kg)	Volume (l)	Quantity
010-1036-000	4,700	0,010	1
010-1038-000	5,600	0,013	1
010-1040-000	6,100	0,016	1

Technical data		010-1036-000	010-1038-000	010-1040-000
Compression ratio		14:1	14:1	14:1
Max pressure supply	bar	8	8	8
Medium air consumption	l/min	220	220	220
Air inlet connection	BSP	F 1/4" G	F 1/4" G	F 1/4" G
Grease outlet connection	BSP	M 1/2" G	M 1/2" G	M 1/2" G
Grease delivery capacity 8 bar	g/min	2000	2000	2000
Noise	dB	80	80	80
Shank diameter	mm	30	30	30
Shank length	mm	480	740	940
For drums with capacity of	kg	18-30	50-60	180-220

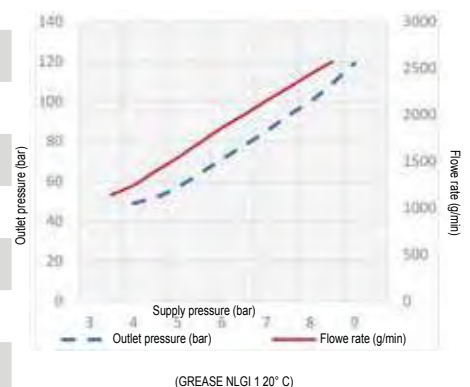

They are suitable for transferring grease with viscosity up to NLGI 2 and to fill central distribution plants, dispensers and manual pumps where a major quantity of grease with slow pressure and short distance is required. The operating pressure of the grease pumps may vary between a minimum of 2.5 bar and a maximum of 8 bar. In order to optimize the efficiency and the life of our air-operated pumps we recommend to use filtered and lubricated air.

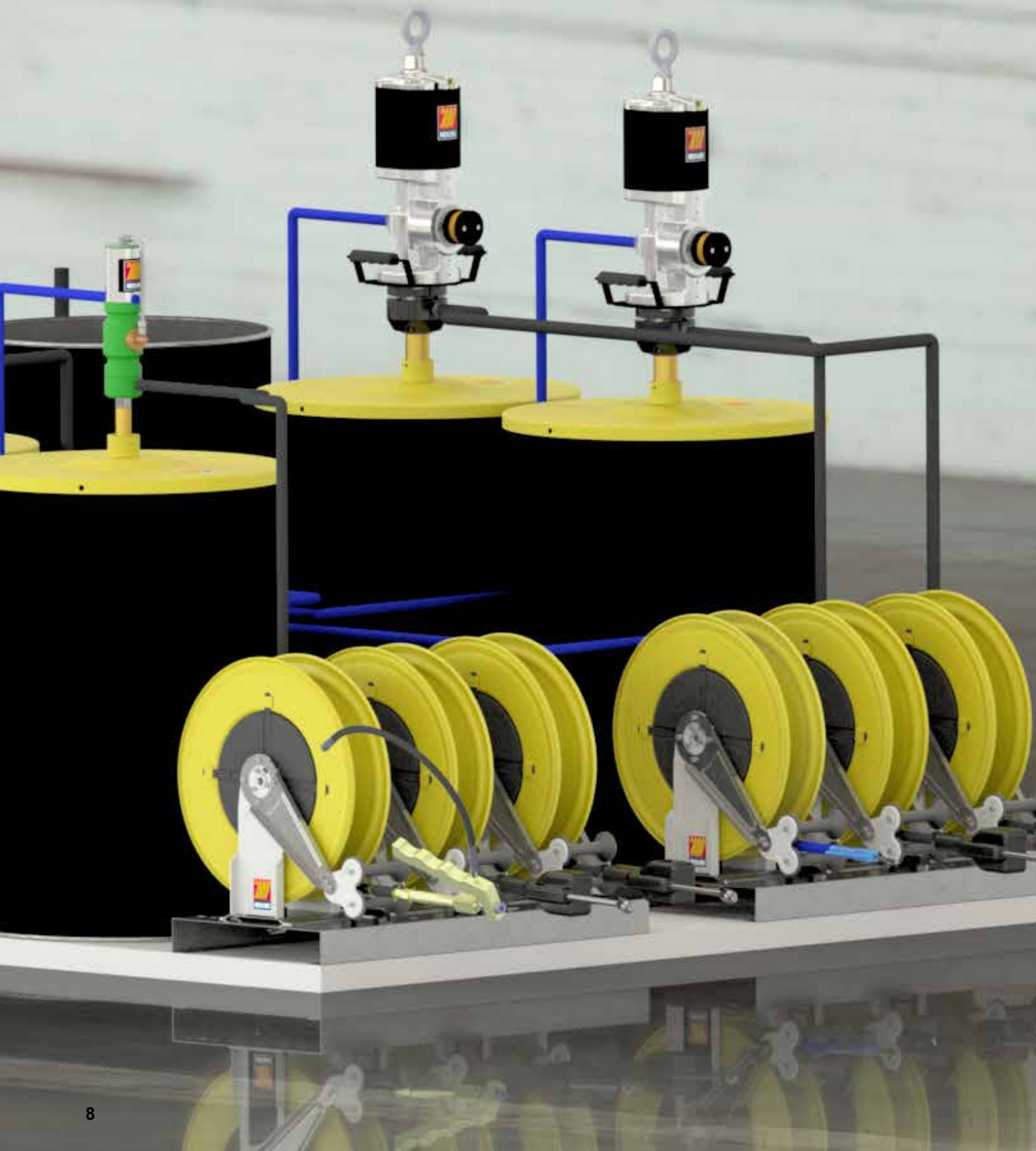

# AIR-OPERATED GREASE PUMP KITS FOR DRUMS 15-30 KG



## Art. 013-1096-000

**Air-operated wheeled grease kit for 16 kg**

Composed by:

Wheeled tank for 16 kg

Art.010-1005-000 Grease pump **R=60:1**

Art.014-1059-030 Follower plate  $\varnothing$  220 mm

Art.907-0102-040 2SC 1/4" hose - 4.0 m length

Art.014-1081-000 Grease gun with swivelling joint

			
013-1096-000	17,800	0,010	2

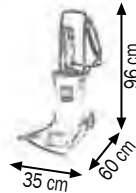
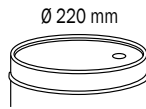

013-1096-000

## Art. 013-1099-000

**Grease kit suitable for drums 15 Kg**

Composed by:

Art.010-1000-000 Grease pump **R=60:1**

Art.014-1095-000 Handle

Art.014-1050-030 Lid  $\varnothing$  280 mm

Art.014-1060-030 Follower plate  $\varnothing$  265 mm

Art.907-0102-040 2SC 1/4" hose - 4.0 m length





Art.014-1081-000 Grease gun with swivelling joint

## Art. 013-1098-000

**Grease kit suitable for drums 15 Kg**

Composed like Art.013-1099-000 but without:

Art.014-1060-030 Follower plate  $\varnothing$  265 mm

			
013-1099-000	11,160	0,056	1
013-1098-000	10,000	0,056	1

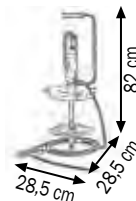
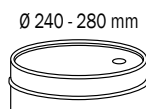

013-1099-000

## Art. 013-1102-000

**Grease kit suitable for drums 18-30 Kg**

Composed by:

Art.010-1005-000 Grease pump **R=60:1**

Art.014-1095-000 Handle

Art.014-1051-030 Lid  $\varnothing$  320 mm

Art.014-1062-030 Follower plate  $\varnothing$  310 mm

Art.907-0102-040 2SC 1/4" hose - 4.0 m length





Art.014-1081-000 Grease gun with swivel joint

## Art. 013-1100-000

**Grease kit suitable for drums 18-30 Kg**

Composed like Art.013-1102-000 but without:

Art.014-1062-030 Follower plate  $\varnothing$  310 mm

			
013-1102-000	11,870	0,056	1
013-1100-000	11,440	0,056	1

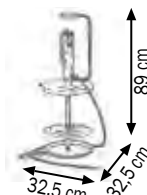
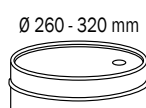

013-1102-000

# AIR-OPERATED GREASE PUMP KITS FOR DRUMS 50-220 KG



**013-1103-000**

## Art. 013-1103-000

Grease kit suitable for drums 50–60 kg

Composed by:

Art.010-1010-000 Grease pump **R=60:1**

Art.014-1054-030 Lid Ø 420 mm

Art.014-1065-030 Follower plate Ø 400 mm

Art.907-0102-040 2SC 1/4" hose – 4.0 m length

Art.014-1081-000 Grease gun with swivelling joint

## Art. 013-1103-A00

Grease kit suitable for drums 50–60 kg

Composed like Art.013-1103-000 but with:

Art.010-1025-000 Grease pump **R=70:1**

## Art. 013-1103-B00

Grease kit suitable for drums 50–60 kg

Composed like Art.013-1103-000 but with:

Art.010-1034-000 Grease pump **R=100:1**



<b>013-1103-000</b>	12,600	0,079	1
<b>013-1103-A00</b>	13,000	0,079	1
<b>013-1103-B00</b>	13,000	0,079	1

Ø 370 - 420 mm

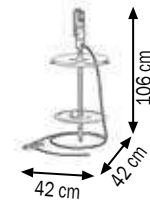

**013-1104-000**

## Art. 013-1104-000

Grease kit suitable for drums 180–220 kg

Composed by:

Art.010-1015-000 Grease pump **R=60:1**

Art.014-1056-030 Lid Ø 600 mm

Art.014-1066-030 Follower plate Ø 590 mm

Art.907-0102-040 2SC 1/4" hose – 4.0 m length

Art.014-1081-000 Grease gun with swivelling joint

## Art. 013-1104-A00

Grease kit suitable for drums 180–220 kg

Composed like Art.013-1104-000 but with:

Art.010-1030-000 Grease pump **R=70:1**

## Art. 013-1104-B00

Grease kit suitable for drums 180–220 kg

Composed like Art.013-1104-000 but with:

Art.010-1035-000 Grease pump **R=100:1**



<b>013-1104-000</b>	15,500	0,088	2
<b>013-1104-A00</b>	15,870	0,088	2
<b>013-1104-B00</b>	15,870	0,088	2

Ø 550 - 600 mm

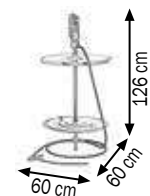

# WHEELED AIR-OPERATED GREASE PUMP KITS FOR DRUMS 18-30 KG



## Art. 013-1106-000

Wheeled grease kit suitable for drums 18-30 kg

Composed by:

- Art.010-1005-000 Grease pump **R=60:1**
- Art.030-1392-000 2- wheels trolley
- Art.014-1051-030 Lid Ø 320 mm
- Art.014-1062-030 Follower plate Ø 310 mm
- Art.907-0102-040 2SC 1/4" hose - 4.0 m length
- Art.014-1081-000 Grease gun with swivelling joint

## Art. 013-1105-000

Wheeled grease kit suitable for drums 18-30 kg

Composed like Art.013-1106-000 but without:

- Art.014-1062-030 Follower plate Ø 310 mm

				Ø 260 - 320 mm
013-1106-000	15,740	0,056	1	
013-1105-000	14,310	0,056	1	

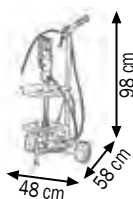

013-1106-000

## Art. 013-1113-000

Wheeled grease kit suitable for drums 25-30 kg

Composed by:

- Art.010-1005-000 Grease pump **R=60:1**
- Art.030-1392-000 2- wheels trolley
- Art.014-1052-030 Lid Ø 350 mm
- Art.014-1063-030 Follower plate Ø 340 mm
- Art.907-0102-040 2SC 1/4" hose - 4.0 m length
- Art.014-1081-000 Grease gun with swivelling joint

				Ø 300 - 350 mm
013-1113-000	16,590	0,056	1	

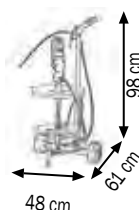

013-1113-000

## Art. 013-1108-000

Wheeled grease kit suitable for drums 18-30 Kg

Composed by:

- Art.010-1005-000 Grease pump **R=60:1**
- Art.030-1393-000 2 pneumatic wheels trolley
- Art.014-1051-030 Lid Ø 320 mm
- Art.014-1062-030 Follower plate Ø 310 mm
- Art.907-0102-040 2SC 1/4" hose - 4.0 m length
- Art.014-1081-000 Grease gun with swivelling joint

## Art. 013-1110-000

Wheeled grease kit suitable for drums 25-30 Kg

Composed like Art.013-1108-000 but with:

- Art.014-1052-030 Lid Ø 350 mm
- Art.014-1063-030 Follower plate Ø 340 mm

				Ø 260 - 350 mm
013-1108-000	18,000	0,056	1	
013-1110-000	19,000	0,056	1	

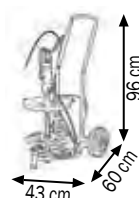

013-1108-000

# WHEELED AIR-OPERATED GREASE PUMP KITS FOR DRUMS 50-60 KG



**013-1118-000**

## Art. 013-1118-000

Wheeled grease kit suitable for drums 50–60 kg

Composed by:

- Art.010-1010-000 Grease pump **R=60:1**
- Art.030-1394-000 2-pneumatic wheels trolley
- Art.014-1053-030 Lid Ø 395 mm
- Art.014-1064-030 Follower plate Ø 370 mm
- Art.907-0102-040 2SC 1/4" hose – 4.0 m length
- Art.014-1081-000 Grease gun with swivelling joint

## Art. 013-1117-000

Wheeled grease kit suitable for drums 50–60 kg

Composed like Art.013-1118-000 but without:

- Art.014-1064-030 Follower plate Ø 370 mm



Ø 340 - 385 mm

<b>013-1118-000</b>	19,650	0,079	1
<b>013-1117-000</b>	17,470	0,079	1

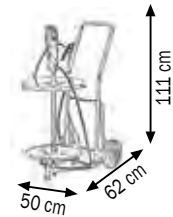

**013-1116-000**

## Art. 013-1116-000

Wheeled grease kit suitable for drums 50–60 kg

Composed by:

- Art.010-1010-000 Grease pump **R=60:1**
- Art.030-1394-000 2-pneumatic wheels trolley
- Art.014-1054-030 Lid Ø 420 mm
- Art.014-1065-030 Follower plate Ø 400 mm
- Art.907-0102-040 2SC 1/4" hose – 4.0 m length
- Art.014-1081-000 Grease gun with swivelling joint

## Art. 013-1115-000

Wheeled grease kit suitable for drums 50–60 kg

Composed like Art.013-1116-000 but without:

- Art.014-1065-030 Follower plate Ø 400 mm



Ø 370 - 420 mm

<b>013-1116-000</b>	20,300	0,079	1
<b>013-1115-000</b>	17,800	0,079	1

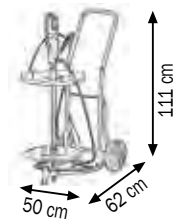

**013-1120-000**

## Art. 013-1120-000

Wheeled grease kit suitable for drums 50–60 kg

Composed by:

- Art.010-1010-000 Grease pump **R=60:1**
- Art.030-1395-000 4 - wheels trolley
- Art.014-1054-030 Lid Ø 420 mm
- Art.014-1065-030 Follower plate Ø 400 mm
- Art.907-0102-040 2SC 1/4" hose – 4.0 m length
- Art.014-1081-000 Grease gun with swivelling joint



Ø 370 - 420 mm

<b>013-1120-000</b>	26,800	0,079	1
---------------------	--------	-------	---

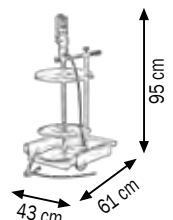

# WHEELED AIR-OPERATED GREASE PUMP KITS FOR DRUMS 180-220 KG



## Art. 013-1121-000

Wheeled grease kit suitable for drums 180–220 kg

Composed by:

- Art.010-1015-000 Grease pump **R=60:1**
- Art.030-1398-000 3-wheels trolley
- Art.014-1056-030 Lid Ø 600 mm
- Art.014-1066-030 Follower plate Ø 590 mm
- Art.907-0102-040 2SC 1/4" hose – 4.0 m length
- Art.014-1081-000 Grease gun with swivelling joint

			
013-1121-000	45,070	0,200	2

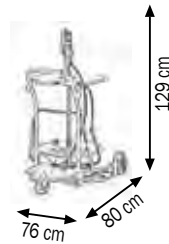
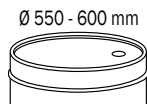

013-1121-000

## Art. 013-1122-000

Wheeled grease kit suitable for drums 180–220 kg with hose reel

Composed by:

- Art.010-1015-000 Grease pump **R=60:1**
- Art.030-1398-000 3-wheels trolley
- Art.014-1056-030 Lid Ø 600 mm
- Art.014-1066-030 Follower plate Ø 590 mm
- Art.907-0122-015 2SC 1/4" hose – 1.5 m length
- Art.014-1081-010 Gun with flexible pipe and fitting with triple-swivelling joint
- Art.070-1207-110 Hose reel with 2SC 1/4" hose **10.0 m** length

			
013-1122-000	56,900	0,246	3

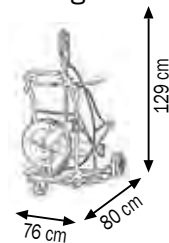
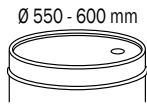





013-1122-000

## Art. 013-1123-000

Wheeled grease kit suitable for drums 180–220 kg with hose reel

Composed by:

- Art.010-1030-000 Grease pump **R=70:1**
- Art.030-1398-000 3-wheels trolley
- Art.014-1056-030 Lid Ø 600 mm
- Art.014-1066-030 Follower plate Ø 590 mm
- Art.907-0122-015 2SC 1/4" hose – 1.5 m length
- Art.014-1081-010 Gun with flexible pipe and fitting with triple-swivelling joint 1/4"
- Art.070-1307-118 Hose reel with 2SC 1/4" hose **18.0 m** length

			
013-1123-000	66,700	0,246	3

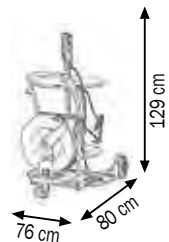
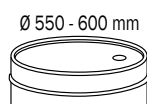

013-1123-000

# WHEELED AIR-OPERATED GREASE PUMP KITS FOR DRUMS 180-220 KG



**013-1125-000**

## Art. 013-1125-000

Wheeled grease kit suitable for drums 180–220 kg

Composed by:

Art.010-1015-000 Grease pump **R=60:1**

Art.030-1400-000 4-wheels trolley

Art.014-1056-030 Lid Ø 600 mm

Art.014-1066-030 Follower plate Ø 590 mm

Art.907-0102-040 2SC 1/4" hose – 4.0 m length

Art.014-1081-000 Grease gun with swivelling joint



**013-1125-000** 55,780 0,200 2

Ø 550 - 600 mm



**013-1130-000**

## Art. 013-1130-000

Wheeled grease kit suitable for drums 180–220 kg

Composed by:

Art.010-1015-000 Grease pump **R=60:1**

Art.030-1405-000 4-wheels trolley

Art.014-1056-030 Lid Ø 600 mm

Art.014-1066-030 Follower plate Ø 590 mm

Art.907-0102-040 2SC 1/4" hose – 4.0 m length

Art.014-1081-010 Gun with flexible pipe and fitting with triple-swivelling joint



**013-1130-000** 67,680 0,200 2

Ø 550 - 600 mm

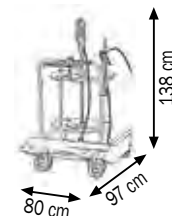

**013-1135-000**

## Art. 013-1135-000

Wheeled grease kit suitable for drums 180–220 kg with hose reel

Composed by:

Art.010-1015-000 Grease pump **R=60:1**

Art.030-1405-000 4-wheels trolley

Art.014-1056-030 Lid Ø 600 mm

Art.014-1066-030 Follower plate Ø 590 mm

Art.907-0122-015 2SC 1/4" hose – 1.5 m length

Art.014-1081-010 Gun with flexible pipe and fitting with triple-swivelling joint

Art.070-1207-110 Hose reel with 2SC 1/4" hose **10.0 m** length



**013-1135-000** 83,290 0,246 3

Ø 550 - 600 mm

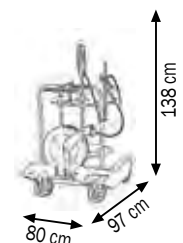

# WALL-FIXED AIR-OPERATED GREASE KITS FOR DRUMS 50-220 Kg



## Art. 013-1136-000

Wall-fixing grease kit suitable for drums 50–60 kg

Composed by:

Art.010-1010-000 Grease pump **R=60:1**

Art.071-1207-110 Orientable hose reel with 2SC 1/4" hose **10,0 m** length

Art.014-1054-030 Lid Ø 420 mm

Art.014-1065-030 Follower plate Ø 400 mm

Art.907-0122-015 2SC 1/4" hose – 1.5 m length

Art.014-1081-010 Gun with flexible pipe and fitting with triple-swivelling joint





Art.024-1785-000 Support for picking up drops

## Art. 013-1137-000

Wall-fixing grease kit suitable for drums 50–60 kg

Composed like Art.013-1136-000 but with:

Art.071-1207-115 Orientable hose reel with 2SC 1/4" hose **15,0 m** length

			
<b>013-1136-000</b>	34,000	0,122	4
<b>013-1137-000</b>	36,500	0,122	4

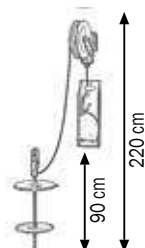
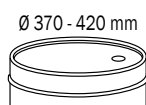

**013-1136-000**

## Art. 013-1138-000

Wall-fixing grease kit suitable for drums 180–220 kg

Composed by:

Art.010-1015-000 Grease pump **R=60:1**

Art.071-1207-110 Orientable hose reel with 2SC 1/4" hose **10,0 m** length

Art.014-1056-030 Lid Ø 600 mm

Art.014-1066-030 Follower plate Ø 590 mm

Art.907-0122-015 2SC 1/4" hose – 1.5 m length

Art.014-1081-010 Gun with flexible pipe and fitting with triple-swivelling joint





Art.024-1785-000 Support for picking up drops

## Art. 013-1139-000

Wall-fixing grease kit suitable for drums 180–220 Kg

Composed like Art.013-1138-000 but with:

Art.071-1207-115 Orientable hose reel with 2SC 1/4" hose **15,0 m** length

			
<b>013-1138-000</b>	40,860	0,151	4
<b>013-1139-000</b>	42,700	0,151	4

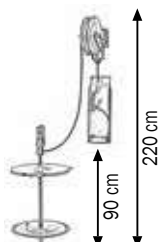
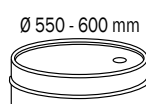

**013-1138-000**

## WALL-FIXED AIR-OPERATED GREASE KITS FOR DRUMS 50-220 Kg



**013-1138-A10**

### Art. 013-1138-A10

Wall-fixing grease kit suitable for drums 180–220 kg

Composed by:

Art.010-1015-000 Grease pump **R=60:1**

Art.070-1207-110 Hose reel with 2SC 1/4" hose **10,0 m** length

Art.014-1056-030 Lid Ø 600 mm

Art.014-1066-030 Follower plate Ø 590 mm

Art.907-0122-015 2SC 1/4" hose – 1.5 m length

Art.014-1081-010 Gun with flexible pipe and fitting with triple-swivelling joint

### Art. 013-1138-A15

Wall-fixing grease kit suitable for drums 180–220 kg

Composed like Art.013-1138-A10 but with:

Art.070-1207-115 Hose reel with 2SC 1/4" hose **15,0 m** length



<b>013-1138-A10</b>	33,600	0,151	3
<b>013-1138-A15</b>	38,000	0,160	3

Ø 550 - 600 mm

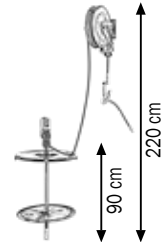

**013-1138-C10**

### Art. 013-1138-C10

Wall- fixing grease kit suitable for drums 180–220 kg

Composed by:

Art.010-1015-000 Grease pump **R=60:1**

Art.074-4507-110 Closed hose reel with 2SC 1/4" hose **10,0 m** length

Art.014-1056-030 Lid Ø 600 mm

Art.014-1066-030 Follower plate Ø 590 mm

Art.907-0122-015 2SC 1/4" hose – 1.5 m length

Art.014-1081-010 Gun with flexible pipe and fitting with triple-swivelling joint

### Art. 013-1138-C15

Wall-fixing grease kit suitable for drums 180–220 Kg

Composed like Art.013-1138-C10 but with:

Art.074-4507-115 Closed hose reel with 2SC 1/4" hose **15,0 m** length



<b>013-1138-C10</b>	42,600	0,160	3
<b>013-1138-C15</b>	45,600	0,160	3

Ø 550 - 600 mm

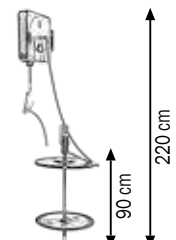

## Art. 013-1932-010

Wall-fixing grease kit suitable for drums 180-220 kg

Composed by:

Art.010-1015-000 Grease pump **R=60:1**

Art.023-1905-000 Tank of dump and stocking for 1 drum 180-220 kg

Art.074-4507-110 Closed fixed hose reel with 2SC 1/4" hose **10,0 m** length

Art.014-1056-030 Cover Ø 600 mm

Art.014-1066-030 Follower plate Ø 590 mm

Art.907-0122-015 2SC 1/4" hose - 1.5 m length





Art.014-1081-010 Gun with flexible pipe and fitting with triple-swivelling joint

## Art. 013-1932-015

Wall-fixing grease kit suitable for drums 180-220 kg

Composed like Art.013-1932-010 but with:

Art.074-4507-115 Closed fixed hose reel with 2SC 1/4" hose **15,0 m** length

				
013-1932-010	110,000	0,570	5	
013-1932-015	112,000	0,570	5	

Ø 550 - 600 mm

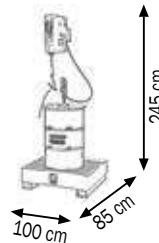
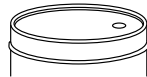

013-1932-010

## Art. 013-1933-010

Complete installation 1 position for drums 180-220 kg

Composed by:

Art.010-1015-000 Grease pump **R=60:1**

Art.023-1925-000 Tank of dump complete with supporting structure for 1 position

Art.074-4507-110 Closed fixed hose reel with 2SC 1/4" hose **10,0 m** length

Art.014-1056-030 Lid Ø 600 mm

Art.014-1066-030 Follower plate Ø 590 mm

Art.907-0122-015 2SC 1/4" hose - 1.5 m length





Art.014-1081-010 Gun with flexible pipe and fitting with triple-swivelling joint

## Art. 013-1933-015

Complete installation 1 position for drums 180-220 Kg

Composed like Art.013 1933 010 but with:

Art.074-4507-115 Closed fixed hose reel with 2SC 1/4" hose **15,0 m** length

				
013-1933-010	140,000	0,600	5	
013-1933-015	142,000	0,600	5	

Ø 550 - 600 mm

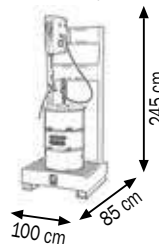
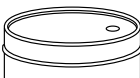

013-1933-010

Fix and complete installation that offers an independent working station. They allow an optimal placing in every working environment (factories and repair shops) allowing to operate in a clean and safe way and without wasting of lubricant oils for different uses.



**013-1155-020**

## Art. 013-1155-020

Grease transfer kit for drums 18-30 kg

Composed by:

Art.010-1036-000 Air-operated grease pump **R=14:1**

Art.014-1095-000 Handle

Art.014-1051-030 Lid Ø 320 mm

Art.014-1062-030 Follower plate Ø 310 mm

Art.906-0404-040 1SC 1/2" hose L. 4,0 m

Art.R30-0400-004 Ball valve F-F 1/2"

Art.F96-0100-402 Steel znt nipple M 1/2" BSP-M 1/4" BSP

Art.F96-0500-002 Quick coupler F 1/4"

Art.F96-0502-002 Quick coupler M 1/4"

			
<b>013-1155-020</b>	10,800	0,056	1

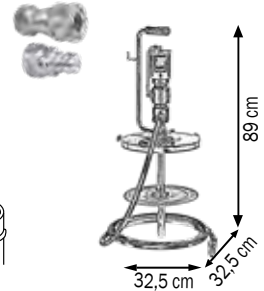

**013-1155-050**

## Art. 013-1155-050

Grease transfer kit for drums 50-60 kg

Composed by:

Art.010-1038-000 Air-operated grease pump **R=14:1**

Art.014-1054-030 Lid Ø 420 mm

Art.014-1065-030 Follower plate Ø 400 mm





Art.906-0404-040 1SC 1/2" hose L. 4,0 m

Art.R30-0400-004 Ball valve F-F 1/2"

Art.F96-0100-402 Steel znt nipple M 1/2" BSP-M 1/4" BSP

Art.F96-0500-002 Quick coupler F 1/4"

Art.F96-0502-002 Quick coupler M 1/4"

			
<b>013-1155-050</b>	13,000	0,079	1

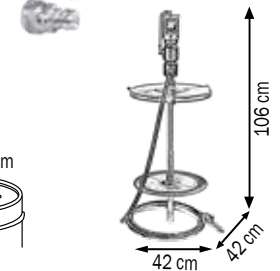
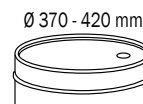

**013-1155-200**

## Art. 013-1155-200

Grease transfer kit for drums 180-220 kg

Composed by:

Art.010-1040-000 Air-operated grease pump **R=14:1**

Art.014-1056-030 Lid Ø 600 mm

Art.014-1066-030 Follower plate Ø 590 mm

Art.906-0404-040 1SC 1/2" hose L. 4,0 m

Art.R30-0400-004 Ball valve F-F 1/2"

Art.F96-0100-402 Steel znt nipple M 1/2" BSP-M 1/4" BSP

Art.F96-0500-002 Quick coupler F 1/4"

Art.F96-0502-002 Quick coupler M 1/4"

			
<b>013-1155-200</b>	17,600	0,088	2

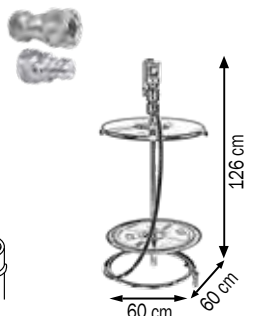
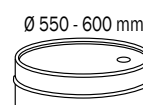

# WHEELED AIR-OPERATED PUMP KITS FOR GREASE TRANSFER FOR DRUMS 18-220 KG



## Art. 013-1160-020

### Grease transfer kit for drums 18-30 kg

Composed by:

- Art.010-1036-000 Air-operated grease pump **R=14:1**
- Art.030-1393-000 Trolley with 2 pneumatic wheels
- Art.014-1051-030 Lid Ø 320 mm
- Art.014-1062-030 Follower plate Ø 310 mm
- Art.906-0404-040 1SC 1/2" hose L. 4,0 m
- Art.R30-0400-004 Ball valve F-F 1/2"
- Art.F96-0100-402 Steel znt nipple M 1/2" BSP-M 1/4" BSP
- Art.F96-0500-002 Quick coupler F 1/4"
- Art.F96-0502-002 Quick coupler M 1/4"



013-1160-020 17,700 0,056 1

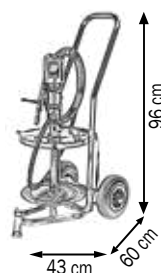
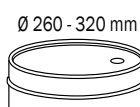

013-1160-020

## Art. 013-1160-050

### Grease transfer kit for drums 50-60 kg

Composed by:

- Art.010-1038-000 Air-operated grease pump **R=14:1**
- Art.030-1394-000 Trolley with 2 pneumatic wheels
- Art.014-1054-030 Lid Ø 420 mm
- Art.014-1065-030 Follower plate Ø 400 mm
- Art.906-0404-040 1SC 1/2" hose L. 4,0 m
- Art.R30-0400-004 Ball valve F-F 1/2"
- Art.F96-0100-402 Steel znt nipple M 1/2" BSP-M 1/4" BSP
- Art.F96-0500-002 Quick coupler F 1/4"
- Art.F96-0502-002 Quick coupler M 1/4"



013-1160-050 20,000 0,079 1

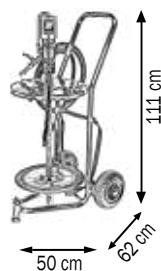
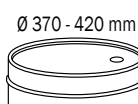

013-1160-050

## Art. 013-1160-200

### Grease transfer kit for drums 180-220 kg

Composed by:

- Art.010-1040-000 Air-operated grease pump **R=14:1**
- Art.030-1400-000 Trolley with 4 wheels
- Art.014-1056-030 Lid Ø 600 mm
- Art.014-1066-030 Follower plate Ø 590 mm
- Art.906-0404-040 1SC 1/2" hose L. 4,0 m
- Art.R30-0400-004 Ball valve F-F 1/2"
- Art.F96-0100-402 Steel znt nipple M 1/2" BSP-M 1/4" BSP
- Art.F96-0500-002 Quick coupler F 1/4"
- Art.F96-0502-002 Quick coupler M 1/4"



013-1160-200 54,900 0,200 2

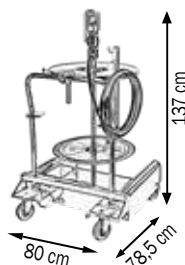
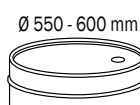

013-1160-200



**013-2000-020**

## Art. 013-2000-020

### Grease sprayer kit for drums 18–30 Kg

Composed by:

Art.010-1005-000 Air-operated grease pump **R=60:1**

Art.014-2170-000 Pressure regulator with connections

Art.014-1095-000 Handle

Art.014-1051-030 Lid Ø 320 mm

Art.014-1062-030 Follower plate Ø 310 mm

Art.907-K122-050 Rubber hoses kit 2SC 1/4”+R6 5/16”with protection l 5,0 m

Art.014-2150-022 Grease spray gun F/160 SP HPS 2,2

Art.014-2160-K19 Nozzles kit for grease spray gun HPS 1,9



**013-2000-020** 12,400 0,056 1

Ø 260 - 320 mm

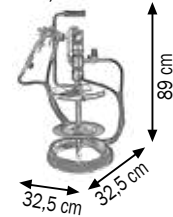

**013-2000-050**

## Art. 013-2000-050

### Grease sprayer kit for drums 50–60 kg

Composed by:

Art.010-1010-000 Air-operated grease pump **R=60:1**

Art.014-2170-000 Pressure regulator with connections

Art.014-1054-030 Lid Ø 420 mm

Art.014-1065-030 Follower plate Ø 400 mm

Art.907-K122-050 Rubber hoses kit 2SC 1/4”+R6 5/16”with protection l 5,0 m

AArt.014-2150-022 Grease spray gun F/160 SP HPS 2,2

Art.014-2160-K19 Nozzles kit for grease spray gun HPS 1,9



**013-2000-050** 15,000 0,079 1

Ø 370 - 420 mm

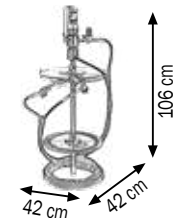

**013-2000-200**

## Art. 013-2000-200

### Grease sprayer kit for drums 180–220 Kg

Composed by:

Art.010-1015-000 Air-operated grease pump **R=60:1**

Art.014-2170-000 Pressure regulator with connections

Art.014-1056-030 Lid Ø 600 mm

Art.014-1066-030 Follower plate Ø 590 mm

Art.907-K122-050 Rubber hoses kit 2SC 1/4”+R6 5/16”with protection l 5,0 m

Art.014-2150-022 Grease spray gun F/160 SP HPS 2,2

Art.014-2160-K19 Nozzles kit for grease spray gun HPS 1,9



**013-2000-200** 19,900 0,088 2

Ø 550 - 600 mm

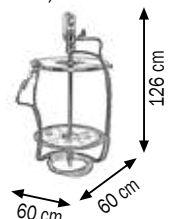

This equipment offers the possibility to spray-nebulize the grease to facilitate the application on big surfaces as a protection. It is used in the following fields: naval, industrial, construction.

This equipment uses an innovative technology that combines the high pressure of the pump and the gun that nebulizes grease with viscosity up to NLGI 2.

# WHEELED AIR-OPERATED GREASE SPRAYER KITS FOR DRUMS 18-220 KG



## Art. 013-2010-020

### Grease sprayer kit for drums 18–30 Kg

Composed by:

- Art.010-1005-000 Air-operated grease pump **R=60:1**
- Art.014-2170-000 Pressure regulator with connections
- Art.030-1393-000 Trolley with 2 pneumatic wheels
- Art.014-1051-030 Lid Ø 320 mm
- Art.014-1062-030 Follower plate Ø 310 mm
- Art.907-K122-050 Rubber hoses kit 2SC 1/4" +R6 5/16" with protection 15,0 m
- Art.014-2150-022 Grease spray gun F/160 SP HPS 2,2
- Art.014-2160-K19 Nozzles kit for grease spray gun HPS 1,9

013-2010-020	20,100	0,056	1	

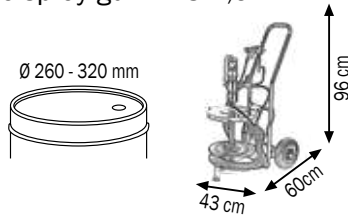

013-2010-020

## Art. 013-2010-050

### Grease sprayer kit for drums 50–60 kg

Composed by:

- Art.010-1010-000 Air-operated grease pump **R=60:1**
- Art.014-2170-000 Pressure regulator with connections
- Art.030-1394-000 Trolley with 2 pneumatic wheels
- Art.014-1054-030 Lid Ø 420 mm
- Art.014-1065-030 Follower plate Ø 400 mm
- Art.907-K122-050 Rubber hoses kit 2SC 1/4" +R6 5/16" with protection 15,0 m
- Art.014-2150-022 Grease spray gun F/160 SP HPS 2,2
- Art.014-2160-K19 Nozzles kit for grease spray gun HPS 1,9

013-2010-050	22,800	0,079	1	

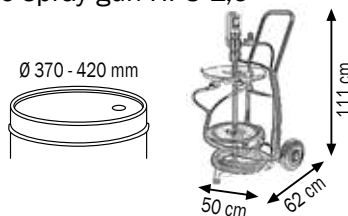

013-2010-050

## Art. 013-2010-200

### Grease sprayer kit for drums 180–220 kg

Composed by:

- Art.010-1015-000 Air-operated grease pump **R=60:1**
- Art.014-2170-000 Pressure regulator with connections
- Art.030-1400-000 4-wheels trolley
- Art.014-1056-030 Lid Ø 600 mm
- Art.014-1066-030 Follower plate Ø 590 mm
- Art.907-K122-050 Rubber hoses kit 2SC 1/4" +R6 5/16" with protection 15,0 m
- Art.014-2150-022 Grease spray gun F/160 SP HPS 2,2
- Art.014-2160-K19 Nozzles kit for grease spray gun HPS 1,9

013-2010-200	57,200	0,200	2	



013-2010-200

This equipment offers the possibility to spray-nebulize the grease to facilitate the application on big surfaces as a protection. It is used in the following fields: naval, industrial, construction.

This equipment uses an innovative technology that combines the high pressure of the pump and the gun that nebulizes grease with viscosity up to NLGI 2.



**014-2150-022**

**Art. 014-2150-022**

Grease spray gun F/160 SP HPS 2,2

This spray gun has been specifically designed to spray grease with viscosity up to NLGI 2.

The air and grease volumes can be individually adjusted

The maximum air pressure is of 4 bar

The maximum grease pressure is of 250 bar



**014-2160-K19**

**Art. 014-2160-K19**

Nozzles kit for grease spray gun HPS 1,9



**014-2160-K22**

**Art. 014-2160-K22**

Nozzles kit for grease spray gun HPS 2,2



**014-2160-K25**

**Art. 014-2160-K25**

Nozzles kit for grease spray gun HPS 2,5



**907-K122-050**

**Art. 907-K122-050**

Rubber hoses kit 2SC 1/4" - R6 5/16" | 5,0 m



**907-K122-100**

**Art. 907-K122-100**

Rubber hoses kit 2SC 1/4" - R6 5/16" | 10,0 m

Composed by 1 high pressure grease hose and 1 hose R6 for air, both hoses are protected by the same reinforced case.



**014-2170-000**

**Art. 014-2170-000**

Pressure regulator with connections for MEC SPRAY

Maximum pressure: 4 bar

## LIDS FOR PUMPS WITH SHANK Ø 30 mm

Article	Ø Lid	For drums	outside Ø
014-1049-030	225 mm	5 Kg	200 - 225 mm
014-1050-030	280 mm	12 - 16 Kg	240 - 280 mm
014-1051-030	320 mm	18 - 30 Kg	260 - 320 mm
014-1052-030	350 mm	20 - 30 Kg	300 - 350 mm
014-1053-030	395 mm	30 - 50 Kg	340 - 395 mm
014-1054-030	420 mm	50 - 60 Kg	370 - 420 mm
014-1056-030	600 mm	180 - 220 Kg	550 - 600 mm



## LID FOR PUMPS WITH SHANK Ø 30 mm FOR PLASTIC DRUMS

014-1051-S30	320 mm	18 - 30 Kg	260 - 320 mm
--------------	--------	------------	--------------

The lids are available in different diameters to fit drums from 5 to 220 kg. A handle provides an easy fit to the drum. It keeps the pump in vertical position in order to assure a perfect working.

## FOLLOWER PLATES FOR PUMPS WITH SHANK Ø 30 mm

Article	Ø Follower Plates	For drums	inside Ø
014-1059-030	220 mm	5 Kg	195 - 210 mm
014-1060-030	265 mm	12 - 16 Kg	240 - 260 mm
014-1061-030	290 mm	16 - 20 Kg	250 - 280 mm
014-1062-030	310 mm	18 - 30 Kg	270 - 300 mm
014-1063-030	340 mm	20 - 30 Kg	300 - 330 mm
014-1064-030	375 mm	30 - 50 Kg	335 - 360 mm
014-1065-030	400 mm	50 - 60 Kg	360 - 400 mm
014-1066-030	590 mm	180 - 220 Kg	540 - 580 mm



It is advisable to use always the follower plate, it is very important when the temperature is low and when high viscosity grease is used. Because of the depression created by the pump, the plate is attracted towards the bottom of the drum by atmospheric pressure. It pushes the grease into the pump and avoids air cavities. It also removes the grease remaining on the walls, down to the bottom of the drums.

### Art. 014-1095-000

#### Handle for grease pumps kits

It has to be applied on the bushing of the lids



014-1095-000



014-1079-000

**Art. 014-1079-000**  
Grease control gun without pipe and coupling  
Thread inlet **F 1/4"**



014-1080-000

**Art. 014-1080-000**  
Grease control gun with flexible hose and 4-jaws coupling  
Length flexible hose: 400 mm  
Thread inlet **F 1/4"**

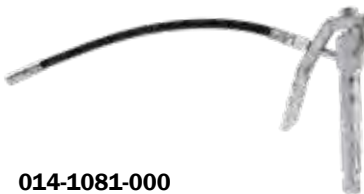

014-1081-000

**Art. 014-1081-000**  
Grease control gun with flexible hose and 4-jaws coupling  
Length flexible hose: 400 mm  
Swivelling joint **F 1/4"**



014-1081-010

**Art. 014-1081-010**  
Grease control gun with flexible hose and 4-jaws coupling  
Length flexible hose: 400 mm  
Triple-swivelling joint **F 1/4"**



014-1082-000

**Art. 014-1082-000**  
Grease control gun with rigid pipe and 4-jaws coupling  
Length rigid pipe: 200 mm  
Thread inlet **F 1/4"**



014-1083-000

**Art. 014-1083-000**  
Grease control gun with rigid pipe and 4-jaws coupling  
Length rigid pipe: 200 mm  
Swivelling joint **F 1/4"**



014-1083-010

**Art. 014-1083-010**  
Grease control gun with rigid pipe and 4-jaws coupling  
Length rigid pipe: 200 mm  
Triple-swivelling joint **F 1/4"**

All grease guns are supplied for the connection of the swivelling joint Art.014-1091-000 or the triple-swivelling joint Art.014-1090-000

## Art. 014-1079-003

Grease control gun without pipe and coupling  
Thread inlet **F 3/8"**



014-1079-003

## Art. 014-1080-003

Grease control gun with flexible hose and 4-jaws coupling  
Length flexible hose: 400 mm  
Thread inlet **F 3/8"**



014-1080-003

## Art. 014-1081-003

Grease control gun with flexible hose and 4-jaws coupling  
Length flexible hose: 400 mm  
Swivelling joint **F 3/8"**



014-1081-003

## Art. 014-1081-013

Grease control gun with flexible hose and 4-jaws coupling  
Length flexible hose: 400 mm  
Triple-swivelling joint **F 3/8"**



014-1081-013

## Art. 014-1082-003

Grease control gun with rigid pipe and 4-jaws coupling  
Length rigid pipe: 200 mm  
Thread inlet **F 3/8"**



014-1082-003

## Art. 014-1083-003

Grease control gun with rigid pipe and 4-jaws coupling  
Length rigid pipe: 200 mm  
Swivelling joint **F 3/8"**



014-1083-003

## Art. 014-1083-013

Grease control gun with rigid pipe and 4-jaws coupling  
Length rigid pipe: 200 mm  
Triple-swivelling joint **F 3/8"**



014-1083-013

All grease guns are supplied for the connection of the swivelling joint Art.014-1091-003 or the triple-swivelling joint Art.014-1090-003



014-1081-S10

**Art. 014-1081-S10**

Gun with lever protection, flexible hose and 4-jaws coupling

Flexible hose length: 400 mm

Triple-swivelling joint **F 1/4"**



014-1081-S13

**Art. 014-1081-S13**

Gun with lever protection, flexible hose and 4-jaws coupling

Flexible hose length: 400mm

Triple-swivelling joint **F 3/8"**



014-1083-S10

**Art. 014-1083-S10**

Gun with lever protection, rigid hose and 4-jaws coupling

Rigid hose length: 200 mm

Triple-swivelling joint **F 1/4"**



014-1083-S13

**Art. 014-1083-S13**

Gun with lever protection, rigid hose and 4-jaws coupling

Rigid hose length: 200 mm

Triple-swivelling joint **F 3/8"**



014-1090-000

**Art. 014-1090-000**

Triple-swivelling joint **M-F 1/4 "**

**Art. 014-1090-003**

Triple-swivelling joint **M-F 3/8 "**



014-1091-000

**Art. 014-1091-000**

Straight swivelling joint **M-F 1/4 "**

**Art. 014-1091-003**

Straight swivelling joint **M-F 3/8 "**



014-1085-000

**Art. 014-1085-000**

Flexible hose length 400 mm

Thread M 10x1 mm



014-1086-000

**Art. 014-1086-000**

Rigid hose length 200 mm

Thread M 10x1 mm

## Art. 014-1084-000

### Grease digital meter K200

Equipped with two displays, one is for batch counting (can be put to zero) and the other one for total volumes (cannot be put to zero) of the dispensed grease.



014-1084-000

## Art. 014-1084-010

### Grease digital meter K200 HP PULSER



014-1084-010

## Art. 014-1084-100

### Grease digital meter nozzle

Composed by:

Digital meter 4 digits

Triple-swivelling joint

Rigid end + 4-jaws coupling

Not approved for public use

Technical data		014-1084-000	014-1084-010	014-1084-100
Flow rate	Kg/min	0,1 - 2,5	0,2 - 5,0	0,1 - 2,5
Inlet connection	BSP	F 1/8"G	F 1/8"G	F 1/4"G
Outlet connection	BSP	F 1/8"G	F 1/8"G	F 10X1
Max working pressure	bar	550	700	550
Batch meter	cifre	4	-	4
Totalizing meter in kg	cifre	4	-	4
Working temperature	max C°	60°	60°	60°
Battery life	mesi	24	-	24



014-1084-100

## Art. 014-1042-000

### Pneumatic nozzle for grease R=50:1

#### 500 cc with rigid pipe and jaws coupling

Suitable for Ø 52 mm 400 g cartridge

It is suitable for the distribution at high pressure of all kinds of grease.

The operating pressure for the grease pumps

may vary between a minimum of 3.5 bar and a maximum of 8.5 bar

Technical data		014-1042-000
Flow rate	g/ciclo	0,68
Compression ratio	bar	50:1
Air consumption	l/min	130
Air inlet connection	BSP	F 1/4"G
Grease outlet connection	M	F 10x1
Grease delivery capacity 6 bar	g/min	1500
Noise level	dB	80
Tank capacity	g	500
Inside diameter of chamber	mm	54
For cartridge ø 52mm	g	400



014-1042-000



**Art. 014-1088-000**  
"PROFI" coupling with 4-jaws hardened case  
M 10x1 mm thread



**Art. 014-1088-A00**  
4-jaws coupling 10x1 mm 90°  
M 10x1 mm thread



**Art. 014-1089-000**  
Grease pull-coupling for hexagonal heads 15 mm  
M 10x1 mm thread



**Art. 014-1089-A00**  
Grease push-coupling for hexagonal heads 15 mm  
M 10x1 mm thread



**Art. 014-1089-B00**  
Giant grease pull-coupling for hexagonal heads 22 mm  
M 10x1 mm thread



### Female quick couplers

Article	Inlet	Pressure	Flow rate	Iso
F96-0500-002	F 1/4"	350 bar	7,2 l/min	7241-A
F96-0500-003	F 3/8"	315 bar	21 l/min	7241-A
F96-0500-004	F 1/2"	250 bar	41 l/min	7241-A



### Male quick couplers

Article	Inlet	Pressure	Flow rate	Iso
F96-0502-002	F 1/4"	350 bar	7,2 l/min	7241-A
F96-0502-003	F 3/8"	315 bar	21 l/min	7241-A
F96-0502-004	F 1/2"	250 bar	41 l/min	7241-A



### Galvanized steel nipples

Article	Inlet	Pressure	Iso
F96-0100-202	1/4"BSP-1/4"BSP	1000 bar	8434-6
F96-0100-303	3/8"BSP-3/8"BSP	1000 bar	8434-6
F96-0100-404	1/2"BSP-1/2"BSP	1000 bar	8434-6
F96-0100-302	3/8"BSP-1/4"BSP	1000 bar	8434-6
F96-0100-403	1/2"BSP-3/8"BSP	1000 bar	8434-6
F96-0100-402	1/2"BSP-1/4"BSP	1000 bar	8434-6



F96-0110-202	1/4"BSP-1/4"NPTF	1000 bar	8434-6
F96-0110-303	3/8"BSP-3/8"NPTF	1000 bar	8434-6
F96-0110-404	1/2"BSP-1/2"NPTF	1000 bar	8434-6
F96-0110-302	3/8"NPTF-1/4"BSP	1000 bar	8434-6
F96-0110-403	1/2"BSP-3/8"NPTF	1000 bar	8434-6

## Art. 014-1087-032

### Quick coupler Meclube-Lock

With hardened 4-jaws made of tool steel  
 With high performance hydraulic-gasket  
 Uncoupling over 600 bar is possible  
 Swivelling joint with thread M 10x1 mm  
 Coupler length 32 mm

**Supplied in blister packaging**



014-1087-032

## Art. 014-1087-081

### Quick coupler Meclube-Lock-L

With hardened 4-jaws made of tool steel  
 With high performance hydraulic-gasket  
 Uncoupling over 600 bar is possible  
 Swivelling joint with thread M 10x1 mm  
 Coupler length 81 mm

**Supplied in blister packaging**



014-1087-081

## THE ADVANTAGES OF THE Meclube-Lock COUPLER

### 1. Simple activation

To activate the coupler you only have to press the lever with the thumb and insert it on the grease gun.

The hardened 4-jaws maintain the coupler firmly inserted.



### 2. Simple release

After you have finished the greasing process, you have to press the lever with the thumb to pull out the coupler from the grease gun.



### 3. Free hands

Once you have activated the coupler, it remains firmly inserted so there is no need to keep it fixed. Its extreme stability allows you to complete the operation with free hands.



### 4. Universality

Its special design allows to use it with all the grease guns configurations: SAE, DIN, BS, etc.

## Art. 014-1087-000

### Meclube-Lock display box

Composed bay:

30 pcs quick couplers Meclube-Lock length 32mm

**Supplied in blister packaging**



014-1087-000

Meclube brand-new **patented** industrial pumps, fully designed and manufactured by Meclube, have remarkable practical features assuring high performances, both for what concerns the quantity and the use at high pressure. The technical quality, the choice of materials and the treatments of tempering and grinding result in the reduction of wear and make these pumps suitable to work reliably in the worst environmental conditions.

- **Brand new fully air-operated motion reverse device, without cams and springs.**  
It has been internally improved to reduce to the minimum the reversal time and to improve the supply of the fluid.
- **Reduced number of wearing parts**
- **The double effect shank grants a higher quantity of delivered grease with constant and continuous flow**
- **High pressure during the functioning, with constant power on all the motion path**
- **The body of the pump is in steel fusion with high silicon level, with electrolytic nickel treatment and chromium plating that ensures high resistance to corrosive agents.**
- **Elements that undergo big stress are in steel 18 NiCrMo 6 and afterwards they are treated and rebored to grant the robustness and minimum frictions.**
- **The pump has a modular structure of high robustness, suitable for heavy duty usages.**



# INDUSTRIAL AIR-OPERATED PUMPS FOR GREASE AND VISCOUS MATERIALS Mod.920 FLANGED

COMPRESSION RATIO R=20:1 DELIVERY= 12000 g/min



## Art. 011-0920-060

Air-operated industrial pump for grease R=20:1  
Mod. 920 flanged double-effect

For drums 18-30 kg and tanks (shank length 600 mm)

Polyurethane seals

For high viscosity grease and oils

## Art. 011-0920-074

Air-operated industrial pump for grease R=20:1  
Mod. 920 flanged double-effect

For drums 50-60 kg (shank length 740 mm)

Polyurethane seals

For high viscosity grease and oils

## Art. 011-0920-086

Air-operated industrial pump for grease R=20:1  
Mod. 920 flanged double-effect

For tanks (shank length 860 mm)

Polyurethane seals

For high viscosity grease and oils

## Art. 011-0920-094

Air-operated industrial pump for grease R=20:1  
Mod. 920 flanged double-effect

For drums 180-220 kg (shank length 940 mm)

Polyurethane seals

For high viscosity grease and oils



011-0920-060	23,100	0,110	1
011-0920-074	25,000	0,150	1
011-0920-086	26,400	0,150	1
011-0920-094	27,400	0,150	1

### Technical Data

		011-0920-060	011-0920-074	011-0920-086	011-0920-094
Compression ratio		20:1	20:1	20:1	20:1
Max supply pressure	bar	8	8	8	8
Air consumption 8 bar	m <sup>3</sup> /min	1,75	1,75	1,75	1,75
Air inlet connection	BSP	F 1/2" G	F 1/2" G	F 1/2" G	F 1/2" G
Grease outlet connection	BSP	F 1/2" G	F 1/2" G	F 1/2" G	F 1/2" G
Grease delivery capacity 8 bar	g/min	12000	12000	12000	12000
Noise	dB	80	80	80	80
Shank diameter	mm	50	50	50	50
Shank length	mm	600	740	860	940
For drums with capacity of	kg	18-30	50-60	TANK	180-220

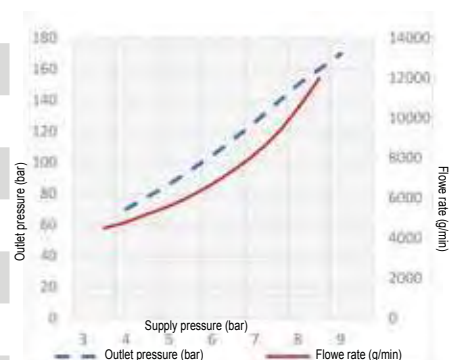

(GREASE NLGI 1 20° C)

Suitable for high pressure transfer of high viscosity grease (maximum NLGI 3) over short and long distances. The double effect grants the supply of a constant and continuous flow. They are suitable for central distribution plants with multiple distribution points. The operating pressure of the pumps may vary between a minimum of 3 bar and a maximum of 8 bar. To optimize the efficiency and the life in time of our air operated pumps Meclube recommends to use filtered and lubricated air.

## Art. 011-0950-050

Air-operated industrial pump for grease R=50:1

Mod. 950 flanged double effect

For drums 18-30 kg and tanks (shank length 500 mm)

Polyurethane seals

For high viscosity grease and oils

## Art. 011-0950-074

Air-operated industrial pump for grease R=50:1

Mod. 950 flanged double effect

For drums 50-60 kg (shank length 740 mm)

Polyurethane seals

For high viscosity grease and oils

## Art. 011-0950-094

Air-operated industrial pump for grease R=50:1

Mod. 950 flanged double effect

For drums 180-220 kg (shank length 940 mm)

Polyurethane seals

For high viscosity grease and oils

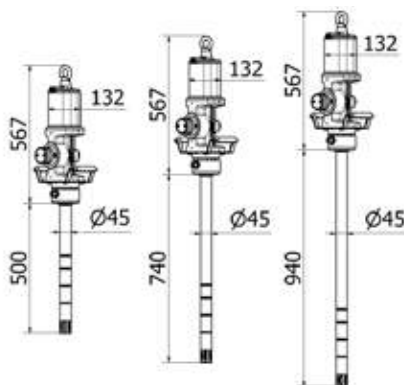

011-0950-050	21,500	0,110	1
011-0950-074	27,300	0,150	1
011-0950-094	29,000	0,150	1

Technical Data		011-0950-050	011-0950-074	011-0950-094
Compression ratio		50:1	50:1	50:1
Max supply pressure	bar	8	8	8
Air consumption 8 bar	m³/min	1,75	1,75	1,75
Air inlet connection	BSP	F 1/2" G	F 1/2" G	F 1/2" G
Grease outlet connection	BSP	F 1/2" G	F 1/2" G	F 1/2" G
Grease delivery capacity 8 bar g/min		6800	6800	6800
Noise	dB	80	80	80
Shank diameter	mm	45	45	45
Shank length	mm	500	740	940
For drums with capacity of	kg	18-30	50-60	180-220

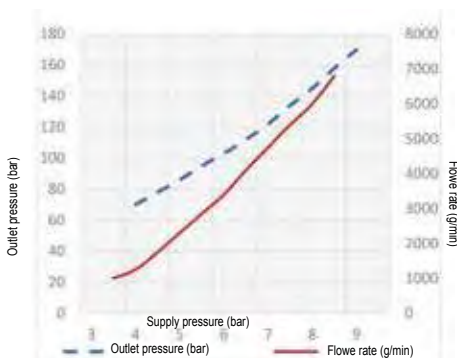

(GREASE NLGI 1 20° C)

Suitable for high pressure transfer of high viscosity grease (maximum NLGI 3) over short and long distances. The double effect grants the supply of a constant and continuous flow. They are suitable for central distribution plants with multiple distribution points. The operating pressure of the pumps may vary between a minimum of 3 bar and a maximum of 8 bar. To optimize the efficiency and the life in time of our air operated pumps Meclube recommends to use filtered and lubricated air.

# INDUSTRIAL AIR-OPERATED PUMPS FOR GREASE AND VISCOUS MATERIALS Mod. 1240 FLANGED

COMPRESSION RATIO=40:1 DELIVERY= 10000 g/min



## Art. 011-1240-060

Air-operated industrial pump for grease R=40:1

Mod. 1240 flanged double-effect

For drums 18-30 kg and tanks (shank length 600 mm)

Polyurethane seals

For high viscosity grease and oils

## Art. 011-1240-074

Air-operated industrial pump for grease R=40:1

Mod. 1240 flanged double-effect

For drums 50-60 kg (shank length 740 mm)

Polyurethane seals

For high viscosity grease and oils

## Art. 011-1240-086

Air-operated industrial pump for grease R=40:1

Mod. 1240 flanged double-effect

For tanks (shank length 860 mm)

Polyurethane seals

For high viscosity grease and oils

## Art. 011-1240-094

Air-operated industrial pump for grease R=40:1

Mod. 1240 flanged double-effect

For drums 180-220 kg (shank length 940 mm)

Polyurethane seals

For high viscosity grease and oils



Art. No.	Price	Capacity	Shank Length
011-1240-060	24,500	0,110	1
011-1240-074	26,300	0,150	1
011-1240-086	31,400	0,150	1
011-1240-094	32,400	0,150	1

Technical Data		011-1240-060	011-1240-074	011-1240-086	011-1240-094
Compression ratio		40:1	40:1	40:1	40:1
Max supply pressure	bar	8	8	8	8
Air consumption 8 bar	m³/min	2,90	2,90	2,90	2,90
Air inlet connection	BSP	F 1/2"G	F 1/2"G	F 1/2"G	F 1/2"G
Grease outlet connection	BSP	F 1/2"G	F 1/2"G	F 1/2"G	F 1/2"G
Grease delivery capacity 8 bar	g/min	10000	10000	10000	10000
Noise	dB	80	80	80	80
Shank diameter	mm	50	50	50	50
Shank length	mm	600	740	860	940
For drums with capacity of	kg	18-30	50-60	TANK	180-220

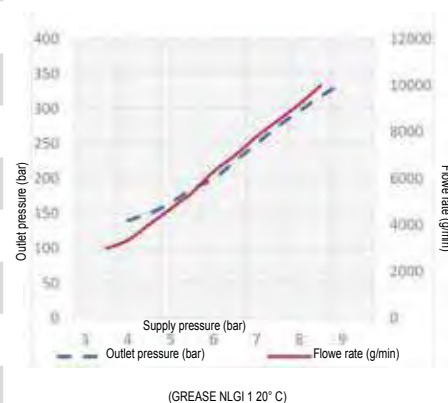

Suitable for high pressure transfer of high viscosity grease (maximum NLGI 3) over short and long distances. The double effect grants the supply of a constant and continuous flow. They are suitable for central distribution plants with multiple distribution points. The operating pressure of the pumps may vary between a minimum of 3 bar and a maximum of 8 bar. To optimize the efficiency and the life in time of our air operated pumps Meclube recommends to use filtered and lubricated air.

## Art. 011-1270-050

Air-operated industrial pump for grease R=70:1

Mod. 1270 flanged double effect

For drums 18-30 kg and tanks (shank length 500 mm)

Polyurethane seals

For high viscosity grease and oil

## Art. 011-1270-074

Air-operated industrial pump for grease R=70:1

Mod. 1270 flanged double effect

For drums of 50-60 kg (shank length 740 mm)

Polyurethane seals

For high viscosity grease and oil

## Art. 011-1270-094

Air-operated industrial pump for grease R=70:1

Mod. 1270 flanged double effect

For drums of 180-220 kg (shank length 940 mm)

Polyurethane seals

For high viscosity grease and oil

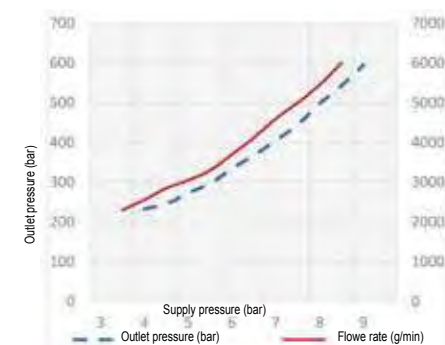
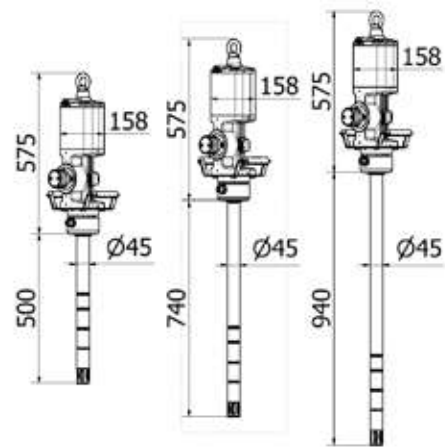

(GREASE NLGI 1 20° C)



Art.	Weight (Kg)	Volume (m³)	No.
011-1270-050	22,900	0,110	1
011-1270-074	28,500	0,150	1
011-1270-094	30,200	0,150	1

Technical data		011-1270-050	011-1270-074	011-1270-094
Compression ratio		70:1	70:1	70:1
Max supply pressure	bar	8	8	8
Air consumption 8 bar	m³/min	2,90	2,90	2,90
Air inlet connection	BSP	F 1/2" G	F 1/2" G	F 1/2" G
Grease outlet connection	BSP	F 1/2" G	F 1/2" G	F 1/2" G
Grease delivery capacity 8 bar	g/min	6000	6000	6000
Noise	dB	80	80	80
Shank diameter	mm	45	45	45
Shank length	mm	500	740	940
For drums with capacity of	kg	TANK	50-60	180-220

Suitable for high pressure transfer of high viscosity grease (maximum NLGI 3) over short and long distances. The double effect grants the supply of a constant and continuous flow. They are suitable for central distribution plants with multiple distribution points. The operating pressure of the pumps may vary between a minimum of 3 bar and a maximum of 8 bar. To optimize the efficiency and the life in time of our air operated pumps Meclube recommends to use filtered and lubricated air.

# INDUSTRIAL AIR-OPERATED PUMPS FOR GREASE AND VISCOUS MATERIALS Mod. 1575 FLANGED

COMPRESSION RATIO=75:1 DELIVERY= 8000 g/min



## Art. 011-1575-060

Air-operated industrial pump for grease R=75:1  
 Mod. 1575 flanged double-effect  
 For drums 18-30 kg and tanks (shank length 600 mm)  
 Polyurethane seals  
 For high viscosity grease and oils

## Art. 011-1575-074

Air-operated industrial pump for grease R=75:1  
 Mod. 1575 flanged double-effect  
 For drums 50-60 kg (shank length 740 mm)  
 Polyurethane seals  
 For high viscosity grease and oils

## Art. 011-1575-086

Air-operated industrial pump for grease R=75:1  
 Mod. 1575 flanged double-effect  
 For tanks (shank length 860 mm)  
 Polyurethane seals  
 For high viscosity grease and oils

## Art. 011-1575-094

Air-operated industrial pump for grease R=75:1  
 Mod. 1575 flanged double-effect  
 For drums 180-220 kg (shank length 940 mm)  
 Polyurethane seals  
 For high viscosity grease and oils

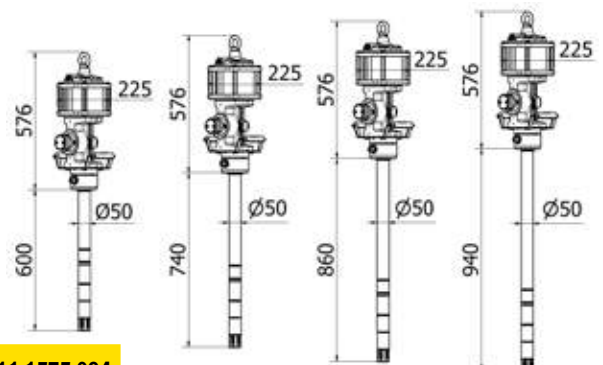

011-1575-060	28,100	0,110	1
011-1575-074	30,500	0,150	1
011-1575-086	32,100	0,150	1
011-1575-094	33,000	0,150	1

Technical Data		011-1575-060	011-1575-074	011-1575-086	011-1575-094
Compression ratio		75:1	75:1	75:1	75:1
Max supply pressure	bar	8	8	8	8
Air consumption 8 bar	m³/min	2,90	2,90	2,90	4,30
Air inlet connection	BSP	F 1/2"G	F 1/2"G	F 1/2"G	F 1/2"G
Grease outlet connection	BSP	F 1/2"G	F 1/2"G	F 1/2"G	F 1/2"G
Grease delivery capacity 8 bar	g/min	8000	8000	8000	8000
Noise	dB	80	80	80	80
Shank diameter	mm	50	50	50	50
Shank length	mm	600	740	860	940
For drums with capacity of	kg	18-30	50-60	TANK	180-220

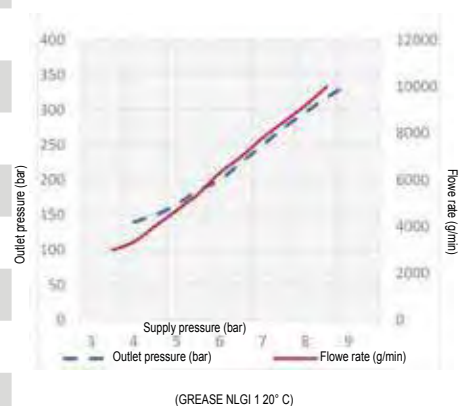

Suitable for high pressure transfer of high viscosity grease (maximum NLGI 3) over short and long distances. The double effect grants the supply of a constant and continuous flow. They are suitable for central distribution plants with multiple distribution points. The operating pressure of the pumps may vary between a minimum of 3 bar and a maximum of 8 bar. To optimize the efficiency and the life in time of our air operated pumps Meclube recommends to use filtered and lubricated air.

**Art. 011-1511-050**

Air-operated industrial pump for grease R=110:1  
 Mod. 1511 flanged double-effect  
 For drums 18-30 kg and tanks (shank length 500 mm)  
 Polyurethane seals  
 For high viscosity grease and oils



**Art. 011-1511-074**

Air-operated industrial pump for grease R=110:1  
 Mod. 1511 flanged double-effect  
 For drums 50-60 kg (shank length 740 mm)  
 Polyurethane seals  
 For high viscosity grease and oils

**Art. 011-1511-094**

Air-operated industrial pump for grease R=110:1  
 Mod. 1511 flanged double-effect  
 For drums 180-220 kg (shank length 940 mm)  
 Polyurethane seals  
 For high viscosity grease and oils

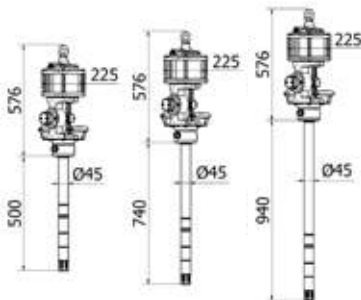

<b>011-1511-050</b>	26,500	0,110	1
<b>011-1511-074</b>	28,800	0,150	1
<b>011-1511-094</b>	30,900	0,150	1

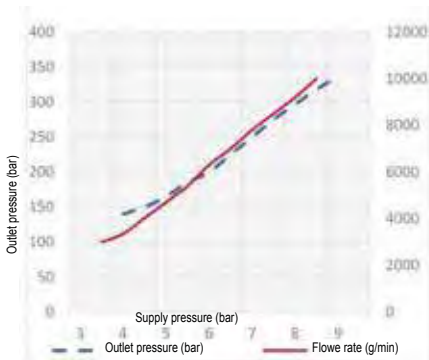

(GREASE NLGI 1 20° C)

Technical Data		011-1511-050	011-1511-074	011-1511-094
Compression ratio		110:1	110:1	110:1
Max supply pressure	bar	8	8	8
Air consumption 8 bar	m <sup>3</sup> /min	4,30	4,30	4,30
Air inlet connection	BSP	F 1/2"G	F 1/2"G	F 1/2"G
Grease outlet connection	BSP	F 1/2"G	F 1/2"G	F 1/2"G
Grease delivery capacity 8 bar g/min		3500	3500	3500
Noise	dB	80	80	80
Shank diameter	mm	45	45	45
Shank length	mm	500	740	940
For drums with capacity of	kg	18-30	50-60	180-220

Suitable for high pressure transfer of high viscosity grease (maximum NLGI 3) over short and long distances. The double effect grants the supply of a constant and continuous flow. They are suitable for central distribution plants with multiple distribution points. The operating pressure of the pumps may vary between a minimum of 3 bar and a maximum of 8 bar. To optimize the efficiency and the life in time of our air operated pumps Meclube recommends to use filtered and lubricated air.

## Art. 011-0920-P60

Air-operated industrial pump for grease R=20:1  
**Mod. 920P flanged double-effect**  
 For frame lifter press (shank length 600 mm)  
 Polyurethane seals  
 For high viscosity grease and oil

## Art. 011-0950-P50

Air-operated industrial pump for grease R=50:1  
**Mod. 950P flanged double-effect**  
 For frame lifter press (shank length 500 mm)  
 Polyurethane seals  
 For high viscosity grease and oil

## Art. 011-1240-P60

Air-operated industrial pump for grease R=40:1  
**Mod. 1240P flanged double-effect**  
 For frame lifter press (shank length 600 mm)  
 Polyurethane seals  
 For high viscosity grease and oil

## Art. 011-1270-P50

Air-operated industrial pump for grease R=70:1  
**Mod. 1270P flanged double-effect**  
 For frame lifter press (shank length 500 mm)  
 Polyurethane seals  
 For high viscosity grease and oil

## Art. 011-1575-P60

Air-operated industrial pump for grease R=75:1  
**Mod. 1575P flanged double-effect**  
 For frame lifter press (shank length 600 mm)  
 Polyurethane seals  
 For high viscosity grease and oil

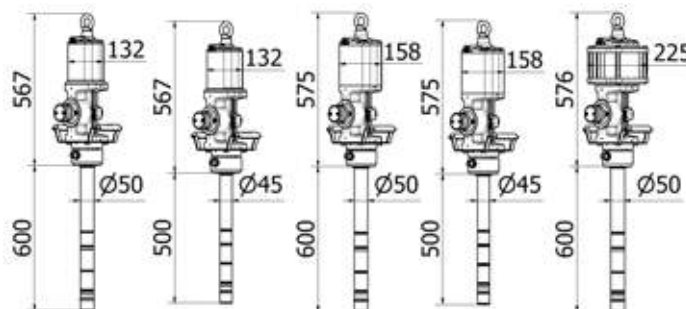

<b>011-0920-P60</b>	20,800	0,110	1	
<b>011-0950-P50</b>	21,600	0,110	1	
<b>011-1240-P60</b>	22,100	0,110	1	
<b>011-1270-P50</b>	22,800	0,110	1	
<b>011-1575-P60</b>	28,000	0,110	1	

Technical data		011-0920-P60	011-0950-P50	011-1240-P60	011-1270-P50	011-1575-P60
Compression ratio		20:1	50:1	40:1	70:1	75:1
Max supply pressure	bar	8	8	8	8	8
Air consumption 8 bar	m³/min	1,75	1,75	2,90	2,90	4,30
Air inlet connection	BSP	F 1/2"G	F 1/2"G	F 1/2"G	F 1/2"G	F 1/2"G
Grease outlet connection	BSP	F 1/2"G	F 1/2"G	F 1/2"G	F 1/2"G	F 1/2"G
Grease delivery capacity 8 bar	g/min	12000	6800	10000	6000	8000
Noise	dB	80	80	80	80	80
Shank diameter	mm	50	45	50	45	50
Shank length	mm	600	500	600	500	600
For drums with capacity of	kg	180-220	180-220	180-220	180-220	180-220

Suitable for high pressure transfer of high viscosity grease (maximum NLGI 3) over short and long distances. The double effect grants the supply of a constant and continuous flow. They are suitable for central distribution plants with multiple distribution points.

## KIT FRAME LIFTER-PRESS AND PUMP FOR GREASE AND HIGH VISCOSITY FLUIDS



**012-1340-P60**

### Art. 012-1320-P60

Kit pump frame lifter and press for grease for drums 180-220 kg with pump R=20:1 Delivery 12 kg/min

Composed by:

Art.012-1200-050 Pump frame lifter and press 2 columns + follower plate

Art.011-0920-P60 Industrial air operated pump **R=20:1**

Art.902-0323-015 Rubber hose R6 3/8" length 1,5 m F-F 3/8"

Art.902-0424-015 Rubber hose R6 1/2" length 1,5 m F-F 1/2"

### Art. 012-1340-P60

Kit pump frame lifter and press for grease for drums 180-220 kg with pump R=40:1 Delivery 10 kg/min

Composed by:

Art.012-1200-050 Pump frame lifter and press 2 columns + follower plate

Art.011-1240-P60 Industrial air operated pump **R=40:1**

Art.902-0323-015 Rubber hose R6 3/8" 1,5 m length F-F 3/8"

Art.902-0424-015 Rubber hose R6 1/2" 1,5 m length F-F 1/2"

### Art. 012-1350-P50

Kit pump frame lifter and press for grease for drums 180-220 kg with pump R=50:1 Delivery 6,8 kg/min

Composed by:

Art.012-1200-045 Pump frame lifter and press 2 columns + follower plate

Art.011-0950-P50 Industrial air operated pump **R=50:1**

Art.902-0323-015 Rubber hose R6 3/8" 1,5 m length F-F 3/8"

Art.902-0424-015 Rubber hose R6 1/2" 1,5 m length F-F 1/2"

### Art. 012-1370-P50

Kit pump frame lifter and press for grease for drums 180-220 kg with pump R=70:1 Delivery 6,0 kg/min

Composed by:

Art.012-1200-045 Pump frame lifter and press 2 columns + follower plate

Art.011-1270-P50 Industrial air operated pump **R=70:1**

Art.902-0323-015 Rubber hose R6 3/8" 1,5 m length F-F 3/8"

Art.902-0424-015 Rubber hose R6 1/2" 1,5 m length F-F 1/2"

### Art. 012-1375-P60

Kit pump frame lifter and press for grease for drums 180-220 kg with pump R=75:1 Delivery 8,0 kg/min

Composed by:

Art.012-1200-050 Pump frame lifter and press 2 columns + follower plate

Art.011-1575-P60 Industrial air operated pump **R=75:1**

Art.902-0323-015 Rubber hose R6 3/8" 1,5 m length F-F 3/8"

Art.902-0424-015 Rubber hose R6 1/2" 1,5 m length F-F 1/2"



<b>012-1320-P60</b>	246,600	1,920	1
<b>012-1340-P60</b>	247,900	1,920	1
<b>012-1350-P50</b>	247,400	1,920	1
<b>012-1370-P50</b>	248,600	1,920	1
<b>012-1375-P60</b>	253,800	1,920	1

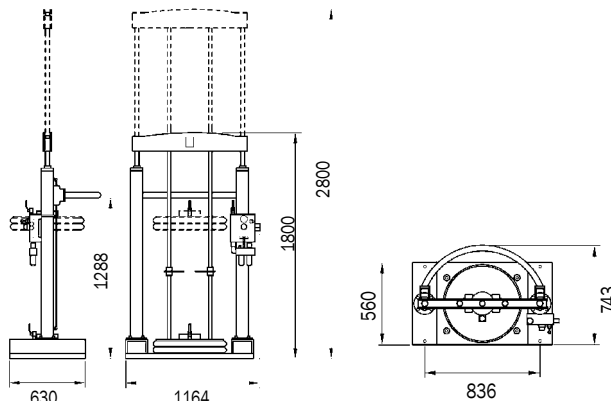
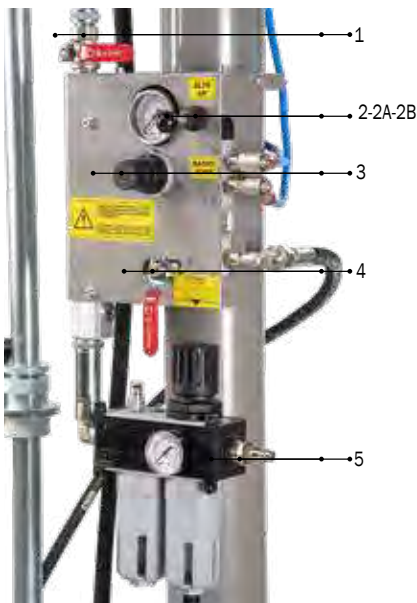

- |    |   |   |  |
|----|---|---|--|
| 1  | Cock for pump air supply                        | 3 | Pressure regulator with manometer for air supply of the lifter |
| 2  | Off position                                    | 4 | Cock for air supply to lift the follower plate                 |
| 2A | Up position to lift the pump and follower plate | 5 | Inlet general air supply into filter and lubricator            |
| 2B | Down position to activate the press-fluid       |   |  |

# FRAME-LIFTER PRESS FOR GREASE AND HIGH VISCOSITY FLUIDS PUMPS



## Art. 012-1200-030

Frame lifter-press for drums 180-220 kg

Equipped with follower plate for grease pumps with shank Ø 30 mm

## Art. 012-1200-045

Frame lifter-press for drums 180-220 kg

Equipped with follower plate for grease pumps with shank Ø 45 mm

## Art. 012-1200-050

Frame lifter-press for drums 180-220 kg

Equipped with follower plate for grease pumps with shank Ø 50 mm

## Art. 012-1200-200

Frame lifter-press for drums 180-220 kg

Equipped with follower plate for grease pumps with shank F 2”G



012-1200-045

Maximum height	Minimum height	Maximum pressure	Pushing power	For drums	Viscosity
2802 mm	1802 mm	8 bar	4 bar - 450 kg 6 bar - 650 kg 8 bar - 870 kg	180 - 220 kg	200 - 500 ASTM (25 °C)



012-1200-030	228,000	1,920	1
012-1200-045	228,000	1,920	1
012-1200-050	228,000	1,920	1
012-1200-200	228,000	1,920	1

## Art. 012-1250-030

Aluminium follower plate with rubber double ring Ø 585mm for drums 180-220 kg with adaptor flange for Ø 30 mm shank (Art.012-1255-030)

## Art. 012-1250-045

Aluminium follower plate with rubber double ring Ø 585mm for drums 180-220 kg with adaptor flange for Ø 45 mm shank (Art.012-1255-045)

## Art. 012-1250-050

Aluminium follower plate with rubber double ring Ø 585mm for drums 180-220 kg with adaptor flange for Ø 50 mm shank (Art.012-1255-050)

## Art. 012-1250-200

Aluminium follower plate with rubber double ring Ø 585mm for drums 180-220 kg with adaptor flange for F 2”G shank (Art.012-1255-200)



012-1250-030	27,000	0,070	1
012-1250-045	27,000	0,070	1
012-1250-050	27,000	0,070	1
012-1250-200	27,000	0,070	1

## Air operated two columns pumps lifter and press for grease and viscous medias.

With its particular 3 ways control valve it lifts or pulls down the pump and the follower plate, improving the exchanging effort of 180-220kg (400 lbs) drums.

It is particularly advised for the use with high viscosity grease and medias (from 200CPS to 500ASTM).

The follower plate is pushed down by the pressurised pneumatic cylinders, avoiding grease flow interruptions by air pockets in the grease bed.

Moreover, it allows to collect all the grease from the inner walls down to the bottom of the drum, Pump suction is assisted.



**013-3100-000**

## Art. 013-3100-000

Industrial pump grease kit for drums 180-220 kg

Composed by:

Art.011-0950-094 Grease industrial pump **R=50:1**

Art.014-1056-045 Lid Ø 600 mm

Art.014-1066-045 Follower plate Ø 590 mm

Art.907-0303-040 2SC 3/8" hose lenght 4,0 m

Art.014-1081-013 Gun with flex hose + coupler with triple swivel F3/8"

Art.F96-0210-304 Galvanized steel extension M3/8"G-F1/2"G



**013-3100-000** 41,600 0,140 2

Ø 550 - 600 mm

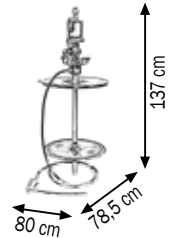

**013-3130-000**

## Art. 013-3130-000

Wheeled industrial pump grease kit for drums 180-220 kg

Composed by:

Art.011-0950-094 Grease industrial pump **R=50:1**

Art.030-1405-000 4 wheels trolley

Art.014-1056-045 Lid Ø 600 mm

Art.014-1066-045 Follower plate Ø 590 mm

Art.907-0303-040 2SC 3/8" hose lenght 4,0 m

Art.014-1081-013 Gun with flex hose + coupler with triple swivel F3/8"

Art.F96-0210-304 Galvanized steel extension M3/8"G-F1/2"G



**013-3130-000** 86,800 0,240 2

Ø 550 - 600 mm

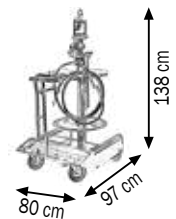

**013-3135-000**

## Art. 013-3135-000

Wheeled industrial pump grease kit for drums 180-220 kg with hose reel

Composed by:

Art.011-0950-094 Grease industrial pump **R=50:1**

Art.030-1405-000 4 wheels trolley

Art.014-1056-045 Lid Ø 600 mm

Art.014-1066-045 Follower plate Ø 590 mm

Art.907-0323-015 2SC 3/8" hose lenght 1,5 m

Art.014-1081-013 Gun with flex hose + coupler with triple swivel F3/8"

Art.070-1307-315 Hose reel with hose 2SC 3/8" | **15,0 m**

Art.F96-0210-304 Galvanized steel extension M3/8"G-F1/2"G



**013-3135-000** 110,200 0,300 3

Ø 550 - 600 mm

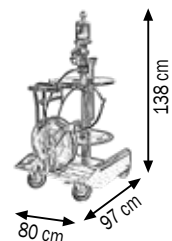

# WALL-FIXED AIR-OPERATED INDUSTRIAL PUMP GREASE KITS FOR DRUMS 180-220 Kg



## Art. 013-3140-015

Wall-fixed industrial pump grease kit for drums 180-220 kg

Composed by:

Art.011-0950-094 Grease industrial pump **R=50:1**

Art.070-1307-315 Hose reel with hose 2SC 3/8" | 15,0 m

Art.014-1056-045 Lid Ø 600 mm

Art.014-1066-045 Follower plate Ø 590 mm

Art.907-0323-015 2SC 3/8" hose lenght 1,5 m

Art.F96-0210-304 Galvanized steel connection M3/8"G-F1/2"G

Art.014-1081-013 Gun with flex hose + coupler with triple swivel F3/8"

Art.024-1785-000 Picking up drops support



013-3140-015

71,100

0,225

4

Ø 370 - 420 mm

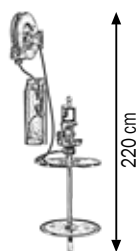

013-3140-015

## Art. 013-3150-015

Wall-fixed industrial pump grease kit for drums 180-220 kg

Composed by:

Art.011-0950-094 Grease industrial pump **R=50:1**

Art.074-4507-315 Closed hose reel with hose 2SC 3/8" | 15,0 m

Art.014-1056-045 Lid Ø 600 mm

Art.014-1066-045 Follower plate Ø 590 mm

Art.907-0323-015 2SC 3/8" hose lenght 1,5 m

Art.F96-0210-304 Galvanized steel connection M3/8"G-F1/2"G

Art.014-1081-013 Gun with flex hose + coupler with triple swivel F3/8"

Art.024-1785-000 Picking up drops support



013-3150-015

77,700

0,225

4

Ø 550 - 600 mm

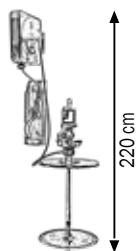

013-3150-015



## LIDS FOR INDUSTRIAL PUMPS WITH SHANK Ø 45 mm

Article	Ø Lid	For drums	outside Ø
<b>014-1053-045</b>	395 mm	30-50 Kg	340-395 mm
<b>014-1054-045</b>	420 mm	50-60 Kg	370-420 mm
<b>014-1056-045</b>	600 mm	180-220 Kg	550-600 mm



## LIDS FOR INDUSTRIAL PUMPS WITH SHANK Ø 50 mm

Article	Ø Lid	For drums	outside Ø
<b>014-1053-050</b>	395 mm	30-50 Kg	340-395 mm
<b>014-1054-050</b>	420 mm	50-60 Kg	370-420 mm
<b>014-1056-050</b>	600 mm	180-220 Kg	550-600 mm



## LIDS FOR INDUSTRIAL PUMPS WITH SLEEVE 2" F

Article	Ø Lid	For drums	outside Ø
<b>014-1053-200</b>	395 mm	30-50 Kg	340-395 mm
<b>014-1054-200</b>	420 mm	50-60 Kg	370-420 mm
<b>014-1056-200</b>	600 mm	180-220 Kg	550-600 mm

They are suitable for the application of the threaded ring for the pumps.

The lids are available in different diameters to fit drums from 50 to 220 kg . A handle provides an easy fit to the drum. It keeps the pump in vertical position in order to assure a perfect working.



## FOLLOWER PLATES FOR INDUSTRIAL PUMPS WITH SHANK Ø 45 mm

Article	Ø Follower Plates	For drums	inside Ø
<b>014-1064-045</b>	375 mm	30-50 kg	335-360 mm
<b>014-1065-045</b>	400 mm	50-60 kg	360-400 mm
<b>014-1066-045</b>	590 mm	180-220 kg	540-580 mm



## FOLLOWER PLATES FOR INDUSTRIAL PUMPS WITH SHANK Ø 50 mm

Article	Ø Follower Plates	For drums	inside Ø
<b>014-1064-050</b>	375 mm	30-50 kg	335-360 mm
<b>014-1065-050</b>	400 mm	50-60 kg	360-400 mm
<b>014-1066-050</b>	590 mm	180-220 kg	540-580 mm

It is advisable to use always the follower plate, it is very important when the temperature is low and when high viscosity grease is used. Because of the depression created by the pump, the plate is attracted towards the bottom of the drum by atmospheric pressure. It pushes the grease into the pump and avoids air cavities. It also removes the grease remaining on the walls, down to the bottom of the drums.

## LIDS FOR INDUSTRIAL PUMPS WITH SHANK Ø 30 mm

They are supplied with 2 tie-rods with handles to fix the drums on vehicles

Article	Ø Lid	For drums	outside Ø
<b>014-1153-030</b>	395 mm	30-50 Kg	340-395 mm
<b>014-1154-030</b>	420 mm	50-60 Kg	370-420 mm
<b>014-1156-030</b>	600 mm	180-220 Kg	550-600 mm



## LIDS FOR INDUSTRIAL PUMPS WITH SHANK Ø 45 mm

They are supplied with 2 tie-rods with handles to fix the drums on vehicles

Article	Ø Lid	For drums	outside Ø
<b>014-1153-045</b>	395 mm	30-50 Kg	340-395 mm
<b>014-1154-045</b>	420 mm	50-60 Kg	370-420 mm
<b>014-1156-045</b>	600 mm	180-220 Kg	550-600 mm



## LIDS FOR INDUSTRIAL PUMPS WITH SHANK Ø 50 mm

They are supplied with 2 tie-rods with handles to fix the drums on vehicles

Article	Ø Lid	For drums	outside Ø
<b>014-1153-050</b>	395 mm	30-50 Kg	340-395 mm
<b>014-1154-050</b>	420 mm	50-60 Kg	370-420 mm
<b>014-1156-050</b>	600 mm	180-220 Kg	550-600 mm



## LIDS FOR INDUSTRIAL PUMPS WITH SLEEVE 2" F

They are supplied with 2 tie-rods with handles to fix the drums on vehicles

Article	Ø Lid	For drums	outside Ø
<b>014-1153-200</b>	395 mm	30-50 Kg	340-395 mm
<b>014-1154-200</b>	420 mm	50-60 Kg	370-420 mm
<b>014-1156-200</b>	600 mm	180-220 Kg	550-600 mm



They are suitable for the application of the threaded ring for the pumps.

The lids are available in different dimensions for drums from 50 to 220 kg. They are provided complete of 2 tie-rods with thimbles and handles to fix the drums on the loading bed of the vehicles.



## Art. K11-3626-115

### Flange for industrial grease pumps

To fix the pumps on the tanks with fixing screws and sealing O-R 142

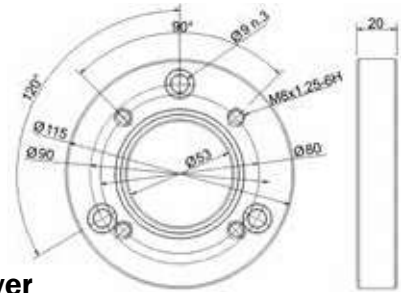

## High pressure 2 ways ball valves with lever



Article	Characteristics	Pressure	Burst	Weight
F96-0600-002	F1/4"-F1/4"	500 bar	30 l/min	0,32 kg
F96-0600-003	F3/8"-F3/8"	500 bar	50 l/min	0,48 kg
F96-0600-004	F1/2"-F1/2"	500 bar	80 l/min	0,66 kg
F96-0600-005	F3/4"-F3/4"	400 bar	120 l/min	1,54 kg
F96-0600-006	F1"-F1"	350 bar	160 l/min	1,98 kg

## Unidirectional check valves



Article	Characteristics	Pressure	Burst	Weight
F96-0700-002	F1/4"-F1/4"	400 bar	30 l/min	0,10 kg
F96-0700-003	F3/8"-F3/8"	400 bar	50 l/min	0,20 kg
F96-0700-004	F1/2"-F1/2"	350 bar	90 l/min	0,32 kg
F96-0700-005	F3/4"-F3/4"	350 bar	110 l/min	0,50 kg
F96-0700-006	F1"-F1"	350 bar	160 l/min	0,70 kg

## Flexible rubber hoses of connection



Article	Characteristics	Pressure	Burst	Length
907-0122-015	2SC 1/4" F - F	W.P.400 bar	1600 bar	1,5 m
907-0122-020	2SC 1/4" F - F	W.P.400 bar	1600 bar	2,0 m
907-0102-030	2SC 1/4" M - F	W.P.400 bar	1600 bar	3,0 m
907-0102-040	2SC 1/4" M - F	W.P.400 bar	1600 bar	4,0 m
907-0102-050	2SC 1/4" M - F	W.P.400 bar	1600 bar	5,0 m
907-0102-060	2SC 1/4" M - F	W.P.400 bar	1600 bar	6,0 m
907-0102-075	2SC 1/4" M - F	W.P.400 bar	1600 bar	7,5 m
907-0102-080	2SC 1/4" M - F	W.P.400 bar	1600 bar	8,0 m
907-0102-100	2SC 1/4" M - F	W.P.400 bar	1600 bar	10,0 m
907-0102-150	2SC 1/4" M - F	W.P.400 bar	1600 bar	15,0 m
907-0323-015	2SC 3/8" F - F	W.P.330 bar	1320 bar	1,5 m
907-0323-020	2SC 3/8" F - F	W.P.330 bar	1320 bar	2,0 m
907-0303-030	2SC 3/8" M - F	W.P.330 bar	1320 bar	3,0 m
907-0303-040	2SC 3/8" M - F	W.P.330 bar	1320 bar	4,0 m
907-0303-050	2SC 3/8" M - F	W.P.330 bar	1320 bar	5,0 m
907-0303-100	2SC 3/8" M - F	W.P.330 bar	1320 bar	10,0 m
907-0303-150	2SC 3/8" M - F	W.P.330 bar	1320 bar	15,0 m
907-0424-015	2SC 1/2" F - F	W.P.275 bar	1100 bar	1,5 m
907-0424-020	2SC 1/2" F - F	W.P.275 bar	1100 bar	2,0 m
907-0404-030	2SC 1/2" M - F	W.P.275 bar	1100 bar	3,0 m
907-0404-040	2SC 1/2" M - F	W.P.275 bar	1100 bar	4,0 m
907-0404-050	2SC 1/2" M - F	W.P.275 bar	1100 bar	5,0 m
907-0404-100	2SC 1/2" M - F	W.P.275 bar	1100 bar	10,0 m
907-0404-150	2SC 1/2" M - F	W.P.275 bar	1100 bar	15,0 m

## Pressure regulators with pressure gauge

Article	Thread	Regulation	Flow rate
014-1045-000	F-F 1/4"	0÷8 bar	2050 NI/min
014-1045-B00	F-F 1/2"	0÷8 bar	3200 NI/min
014-1045-C00	F-F 3/4"	0÷8 bar	6200 NI/min
014-1045-D00	F-F 1"	0÷8 bar	6200 NI/min



## Pressure regulators with filter and pressure gauge

Article	Thread	Regulation	Flow rate	Filtration
014-1046-000	F-F 1/4"	0÷8 bar	1650 NI/min	20 μ
014-1046-B00	F-F 1/2"	0÷8 bar	3000 NI/min	20 μ
014-1046-C00	F-F 3/4"	0÷8 bar	4500 NI/min	20 μ
014-1046-D00	F-F 1"	0÷8 bar	4500 NI/min	20 μ



## Air lubricator

Article	Thread	Regulation	Flow rate
014-1047-000	F-F 1/4"	-	2600 NI/min
014-1047-B00	F-F 1/2"	-	5600 NI/min
014-1047-C00	F-F 3/4"	-	8200 NI/min
014-1047-D00	F-F 1"	-	8200 NI/min



## Pressure regulators with lubricating filter and pressure gauge

Article	Thread	Regulation	Flow rate	Filtration
014-1048-000	F-F 1/4"	0÷8 bar	1100 NI/min	20 μ
014-1048-B00	F-F 1/2"	0÷8 bar	2500 NI/min	20 μ
014-1048-C00	F-F 3/4"	0÷8 bar	4300 NI/min	20 μ
014-1048-D00	F-F 1"	0÷8 bar	4300 NI/min	20 μ



To optimise the performance and the long life of the pneumatic equipment, we suggest to use air without condensation, lubricated and at an adequate pressure.

## Quick conn. "Multiconnection"

Article	Connection
R12-1001-002	Male 1/4"
R12-1001-003	Male 3/8"
R12-1001-004	Male 1/2"
R12-1102-002	Female 1/4"
R12-1102-003	Female 3/8"
R12-1102-004	Female 1/2"



## Connection European profile

Article	Connection
R12-0001-002	Male 1/4"
R12-0001-003	Male 3/8"
R12-0001-004	Male 1/2"
R12-0100-002	Female 1/4"
R12-0100-003	Female 3/8"
R12-0100-004	Female 1/2"



## Male rubber-holder with O-Ring

Article	Connection
R18-0801-062	Male 1/4" Ø 6
R18-0801-082	Male 1/4" Ø 8
R18-0801-102	Male 1/4" Ø 10
R18-0801-122	Male 1/4" Ø 12



## Female rubber-holder

Article	Connection
R18-0802-062	Female 1/4" Ø 6
R18-0802-082	Female 1/4" Ø 8
R18-0802-102	Female 1/4" Ø 10



## Male quick coupler + O-Ring

Article	Connection
R20-0001-052	Male 1/4" Ø 5
R20-0001-062	Male 1/4" Ø 6
R20-0001-082	Male 1/4" Ø 8
R20-0001-102	Male 1/4" Ø 10



## Conic nipple

Article	Connection
R18-0300-202	1/4"M-1/4"F
R18-0300-303	3/8"M-3/8"M
R18-0300-404	1/2"M-1/2"M



## Reduced conic nipple

Article	Connection
R18-0301-302	3/8"M-1/4"M
R18-0301-402	1/2"M-1/4"M
R18-0301-403	1/2"M-3/8"M



## Orientable cil. nipple with O-Ring

Article	Connection
R18-0304-202	1/4"M-1/4"F
R18-0304-303	3/8"M-3/8"F



## Conic reduction

Article	Connection
R18-0500-202	1/4"M-1/4"F
R18-0500-203	1/4"M-3/8"F
R18-0500-204	1/4"M-1/2"F
R18-0500-303	3/8"M-3/8"F
R18-0500-304	3/8"M-1/2"F
R18-0500-404	1/2"M-1/2"F



## Cylindrical cap reduction

Article	Connection
R18-0502-201	1/4"M-1/8"F
R18-0502-302	3/8"M-1/4"F
R18-0502-403	1/2"M-3/8"F
R18-0502-504	3/4"M-1/2"F



## Male plug with hexag. and O-Ring

Article	Connection
R18-4000-002	1/4"M
R18-4000-003	3/8"M
R18-4000-004	1/2"M



## L connection M-F

Article	Connection
R18-1200-002	1/4"M-1/4"F
R18-1200-003	3/8"M-3/8"F
R18-1200-004	1/2"M-1/2"F
R18-1200-005	3/4"M-3/4"F



## Y connection 90° centre male

Article	Connection
R18-1300-002	1/4"M
R18-1300-003	3/8"M







**015-3100-000**

**Art. 015-3100-000**

**Manual lever grease gun Mod. Lube-Mec**

Cartridge screw loading

Equipped with:

Flexible hose 300 mm with 4-jaws coupler

Suitable for screw cartridge Lube-Mec Ø 52 mm 400 g



**015-3132-000**

**Art. 015-3132-000**

**Manual pistol grease gun Mod. Lube-Mec**

Cartridge screw loading

Equipped with:

Flexible hose 300 mm with 4-jaws coupler

Suitable for screw cartridge Lube-Mec Ø 52 mm 400 g



**015-3135-006**

Technical data		015-3100-000	015-3132-000
Working pressure	bar	400	345
Maximum pressure	bar	690	635
Grease flow rate for stroke	cm <sup>3</sup>	0,9	0,5
Screw grease cartridge	g	400	400
Body diameter	mm	60	60
Length	mm	290	275
Grease outlet connection	mm	10x1	10x1



**015-3140-006**

**Art. 015-3135-006**

**Adaptors for screw cartridges for Mod. Lube-Mec**

**Art. 015-3140-006**

**Adaptors for the filling of screw cartridges for Mod. Lube-Mec**

The Lube-Mec system works with a special void technology that ensures the complete use of the grease of the cartridge and it eliminates problems of supply continuity in comparison with traditional systems guns. Since you don't have to unscrew the hose of the head of the greaser, the cartridge recharge is quicker. When replacing the cartridges there are no air cavities.

This technology ensures the usage of all the grease of the cartridge.

With this system there is a very small percentage of wearing parts, so the grease guns are long lasting.

## Art. 015-3102-000

### Manual lever grease gun cm<sup>3</sup> 500 Mod. Standard

Manual and cartridge loading, automatic grease progression

Equipped with:

Flexible hose 300 mm with 4-jaws coupler

Filling valve Ø 9 mm

Suitable for cartridge Ø 52 mm 400 g



015-3102-000

## Art. 015-3104-000

### Manual lever grease gun cm<sup>3</sup> 750 Mod. Standard

Manual and cartridge loading, automatic grease progression

Equipped with:

Flexible hose 300 mm with 4-jaws coupler

Filling valve Ø 9 mm

Suitable for cartridge Ø 52 mm 600 g



015-3104-000

## Art. 015-3105-000

### Manual lever grease gun cm<sup>3</sup> 1000 Mod. Standard

Manual and cartridge loading, automatic grease progression

Equipped with:

Flexible hose 300 mm with 4-jaws coupler

Filling valve Ø 9 mm

Suitable for cartridge Ø 56 mm 600 g



015-3105-000

Technical data		015-3102-000	015-3104-000	015-3105-000
Working pressure	bar	400	400	400
Maximum pressure	bar	680	680	680
Grease flow rate for stroke	cm <sup>3</sup>	0,8	0,8	0,8
Screw grease cartridge	g	400	600	600
Body diameter	mm	57	57	59
Length	mm	380	480	480
Grease outlet connection	mm	10x1	10x1	10x1





**Art. 015-3112-000**

**Manual lever grease gun cm<sup>3</sup> 500 Mod. Profi**

Manual and cartridge loading, automatic grease progression

Equipped with:

Flexible hose 300 mm with 4-jaws coupler

Air discharge coupler

Filling valve Ø 9 mm

Suitable for cartridge Ø 52 mm 400 g



**Art. 015-3118-000**

**Manual lever grease gun cm<sup>3</sup> 750 Mod. Profi**

Manual and cartridge loading, automatic grease progression

Equipped with:

Flexible hose 300 mm with 4-jaws coupler

Air discharge coupler

Filling valve Ø 9 mm

Suitable for cartridge Ø 52 mm 600 g



Technical data		015-3112-000	015-3118-000
Working pressure	bar	690	690
Maximum pressure	bar	800	800
Grease flow rate for stroke	cm <sup>3</sup>	1,0	1,0
Screw grease cartridge	g	400	600
Body diameter	mm	57	57
Lenght	mm	370	480
Grease outlet connection	mm	10x1	10x1

## Art. 015-3152-000

### Manual pistol grip grease gun cm<sup>3</sup> 500 Mod. Mec

Manual and cartridge loading, automatic grease progression

Equipped with:

Flexible hose 300 mm with 4-jaws coupler

Filling valve Ø 9 mm

Suitable for cartridge Ø 52 mm 400 g



015-3152-000

## Art. 015-3162-000

### Manual pistol grip grease gun cm<sup>3</sup> 500 Mod. Premium

Manual and cartridge loading, automatic grease progression

Equipped with:

Flexible hose 300 mm with 4-jaws coupler

Filling valve Ø 9 mm

Suitable for cartridge Ø 52 mm 400 g



015-3162-000

Technical data		015-3152-000	015-3162-000
Working pressure	bar	345	500
Maximum pressure	bar	635	690
Grease flow rate for stroke	cm <sup>3</sup>	0,5	0,7
Screw grease cartridge	g	400	400
Body diameter	mm	57	57
Lenght	mm	350	350
Grease outlet connection	mm	10x1	10x1

## GREASE CARTRIDGES

### Art. 017-3200-400

Litium grease cartridge NLGI 2

Ø 52 mm 400 g (Package of 24 pieces)



017-3200-400

### Art. 017-3210-600

Litium grease cartridge NLGI 2

Ø 52 mm 600 g (Package of 15 pieces)



017-3210-600

### Art. 017-3215-600

Litium grease cartridge NLGI 2

Ø 56 mm 600 g (Package of 15 pieces)



017-3215-600

### Art. 017-3250-400

Litium grease screw cartridge NLGI 2 for Mod. Lube-Mec

Ø 52 mm 400 g (Package of 24 pieces)



017-3250-400

## BATTERY-OPERATED GREASE-GUN 20V PUSH TYPE GREASE GUNS



015-3180-000

Battery-operated grease-gun 20V Li-Ion, suitable for 400g standard and screw Lube-Mec cartridges

The **display** indicates:

Battery level, grease level, amount of grease dispensed and no. cycles. The charger is protected against overload (charging time approx. 100% in 60 min. / 80% in 30 min.)

Fully charged battery dispenses up to 12 grease cartridges in conditions of free exit.

The plastic carry-along case has a space designed for an additional battery

### Battery-operated grease-gun 20V Li-Ion

Article	Capacity	Max pressure	Max delivery	Battery
015-3180-000	500 g	690 bar	85 g/min	20V Li-Ion

Equipped with:

Plastic carry-along case

Battery operated grease-gun 20V Li-Ion

1000 mm flexible hose with 4-jaws coupler

Art. **015-3185-000** Multi purpose wide range input charger (12-240 V/ 50-60 Hz)

Art. **015-3186-000** Li-Ion battery 20V - 2000 mAh

Shoulder strap

It is suitable for 400 g Ø 52 mm standard and screw Lube-Mec cartridges



015-3180-000	6,130	0,010	1
--------------	-------	-------	---



015-3185-000

015-3186-000



### Steel push type grease gun with Zerck coupler

Article	Capacity	Diameter	Length	Max pressure
015-3305-050	50 g	30 mm	160 mm	100 bar
015-3310-200	200 g	45 mm	220 mm	100 bar



015-3305-050

### Push type gun for high pressure grease, telescopic hose with Zerck coupler for spherical head and Lub for concave head

Article	Capacity	Diameter	Length	Max pressure
015-3320-080	80 g	37 mm	150<220 mm	200 bar
015-3320-150	150 g	37 mm	220<350 mm	200 bar
015-3320-300	300 g	47 mm	260<430 mm	200 bar



015-3320-150

### Push type grease gun for the filling of centralized lubrication systems of trucks, agricultural and construction machinery

Article	Capacity	Diameter	Length	Max pressure
015-3350-000	500 g	57 mm	280 mm	200 bar

Manual and cartridge loading Ø 52 mm 400 g



015-3350-000

## Rubber flexible hoses (DIN. 1283)

Article	Diameter	Thread	Max. pressure	Length
017-3253-000	4x10 mm	10x1 mm	1000 bar	300 mm
017-3254-000	4x10 mm	10x1 mm	1000 bar	400 mm
017-3255-000	4x10 mm	10x1 mm	1000 bar	500 mm
017-3257-000	4x10 mm	10x1 mm	1000 bar	750 mm
017-3260-000	4x10 mm	10x1 mm	1000 bar	1000 mm

**Art. 014-1086-000**  
Rigid pipe length 200 mm  
Thread M 10x1 mm



014-1086-000

**Art. 017-1156-000**  
Rigid pipe 200 mm with 4-jaws coupler (Art. 017-1157-000)  
Thread M 10x1 mm



017-1156-000

**Art. 017-1155-000**  
Ball brass spigot  
Thread M-F 10x1 mm



017-1155-000

**Art. 017-1157-000**  
4-jaws coupler for grease  
Thread M 10x1 mm



017-1157-000

**Art. 017-3330-000**  
Grease Zerck coupler for spherical head Ø 12x12  
Thread M 10x1 mm



017-3330-000

**Art. 017-3332-000**  
Grease Lub coupler for concave head Ø 12x19  
Thread M 10x1 mm



017-3332-000

**Art. 017-3354-020**  
Adaptors for push type grease gun (Art. 015-3350-000)  
With protection cap M 20x1,5



017-3354-020

**Art. 017-3354-022**  
Adaptors for push type grease gun (Art. 015-3350-000)  
With protection cap M 22x1,5



017-3354-022

**Art. 017-3354-026**  
Adaptors for push type grease gun (Art. 015-3350-000)  
With protection cap M 26x1,5



017-3354-026

## Button head grease nipples, hexagonal 15 mm, ball check

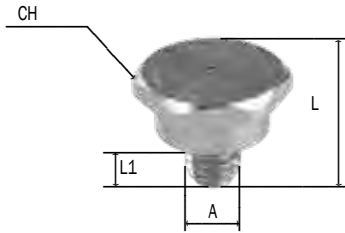

Article	Thread	Dim. L	Dim. L1	Dim. CH	Pieces
015-2902-050	6x1	13	7	15	50
015-2904-050	8x1	13	7	15	50
015-2905-050	8x1,25	13	7	15	50
015-2907-050	10x1	13	7	15	50
015-2909-050	10x1,5	13	7	15	50
015-2915-050	1/8" G	13	7	15	50
015-2916-050	1/4" G	13	7	15	50

## Button head grease nipples, double hexagon 15 mm, ball check

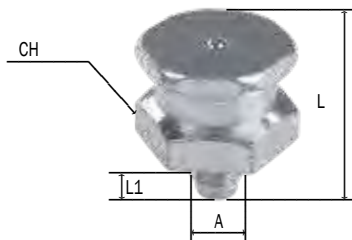

Article	Thread	Dim. L	Dim. L1	Dim. CH	Pieces
015-2918-050	6x1	18	7	15	50
015-2919-050	8x1	18	7	15	50
015-2920-050	8x1,25	18	7	15	50
015-2921-050	10x1	18	7	15	50
015-2923-050	10x1,5	18	7	15	50
015-2925-050	12x1,5	18	7	15	50
015-2926-050	12x1,75	18	7	15	50
015-2930-050	1/8" G	18	7	15	50
015-2931-050	1/4" G	18	7	15	50

## Button-circle head grease nipples Ø 22 mm, valve check



Article	Thread	Dim. L	Dim. L1	Dim. CH	Pieces
015-2940-020	16x1,5 Fiat	32	14	22	20
015-2941-020	1/4" G	32	12	22	20
015-2943-020	3/8" G	32	14	22	20
015-2945-020	3/8" NPT <small>Caterpillar</small>	43	14	22	20

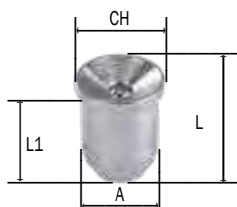

## Concave head grease nipples, straight, smooth stem

Article	Thread	Dim. L	Dim. L1	Dim. CH	Pieces
015-2964-100	6	8	7	7	100
015-2965-100	8	9,5	8	9	100
015-2966-100	10	9,5	7,5	11	100

## Straight hydraulic grease fittings with spherical head

Article	Thread	Dim. L	Dim. L1	Dim. CH	Pieces
015-3010-100	6x1	13,5	5	7	100
015-3012-100	6x1	30	6	7	100
015-3014-100	8x1	18	6	11	100
015-3015-100	8x1,25	18	6	11	100
015-3018-100	10x1	18	7	11	100
015-3019-100	10x1,25	18	7	11	100
015-3020-100	10x1,5	18	7	11	100
015-3025-100	1/8" G	18	7	11	100
015-3026-100	1/4" G	18	7	14	100

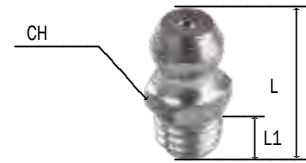

## 45° angled hydraulic grease fittings with spherical head

Article	Thread	Dim. L	Dim. L1	Dim. CH	Pieces
015-3032-100	6x1	25,5	6,5	11	100
015-3035-100	8x1	25,5	6,5	11	100
015-3036-100	8x1,25	25,5	6,5	11	100
015-3038-100	10x1	25,5	6,5	11	100
015-3039-100	10x1,25	25,5	6,5	11	100
015-3040-100	10x1,5	25,5	6,5	11	100
015-3044-100	1/8" G	25,5	6,5	11	100
015-3045-050	1/4" G	25,5	6,5	14	50

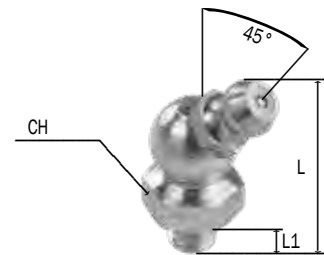

## 90° angled hydraulic grease fittings with spherical head

Article	Thread	Dim. L	Dim. L1	Dim. CH	Pieces
015-3051-100	6x1	25,5	6,5	11	100
015-3055-100	8x1	25,5	6,5	11	100
015-3056-100	8x1,25	25,5	6,5	11	100
015-3058-100	10x1	25,5	6,5	11	100
015-3059-100	10x1,25	25,5	6,5	11	100
015-3060-100	10x1,5	25,5	6,5	11	100
015-3064-100	1/8" G	25,5	6,5	11	100
015-3065-050	1/4" G	25,5	6,5	14	50

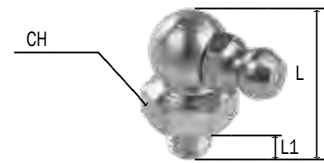

### Art. 015-3089-100

Plastic protection plug for hydraulic grease fittings

Package of 100 pieces.



### Art. 015-3090-070

Set of grease fittings 70 pcs.

Composed by:

Art. 015-3010-000	6x1 straight	10 pcs.
Art. 015-3014-000	8x1 straight	10 pcs.
Art. 015-3018-000	10x1 straight	10 pcs.
Art. 015-3025-000	1/8 G straight	10 pcs.
Art. 015-3032-000	6x1 45°	5 pcs.
Art. 015-3035-000	8x1 45°	5 pcs.
Art. 015-3038-000	10x1 45°	5 pcs.
Art. 015-3051-000	6x1 90°	5 pcs.
Art. 015-3055-000	8x1 90°	5 pcs.
Art. 015-3058-000	10x1 90°	5 pcs.

### Art. 015-3090-140

Set of grease fittings 140 pcs.

Composed by:

Art. 015-3010-000	6x1 straight	25 pcs.
Art. 015-3014-000	8x1 straight	25 pcs.
Art. 015-3018-000	10x1 straight	15 pcs.
Art. 015-3025-000	1/8" G straight	15 pcs.
Art. 015-3032-000	6x1 45°	10 pcs.
Art. 015-3035-000	8x1 45°	10 pcs.
Art. 015-3038-000	10x1 45°	5 pcs.
Art. 015-3044-000	1/8" 45°	5 pcs.
Art. 015-3051-000	6x1 90°	10 pcs.
Art. 015-3055-000	8x1 90°	10 pcs.
Art. 015-3058-000	10x1 90°	5 pcs.
Art. 015-3064-000	1/8" G 90°	5 pcs.



015-3090-070



015-3090-140



**016-1141-000**

**Art. 016-1141-000**

**Manual grease pump 16 kg**

**Outlet grease pressure 400 bar, 60 g delivery each 10 cycles of the lever**

Composed by:

Wheeled tank 16 kg

Art.014-1059-030 Follower plate Ø 220 mm with spring

Art.906-0142-020 1SC 1/4" hose F 1/4" - F 10X1 2.0 m length

Art.017-1155-000 Cock M-F 10x1 mm

Art.017-1156-000 200 mm rigid pipe and 4-jaws coupling



**016-1141-000** 12,850 0,090 1

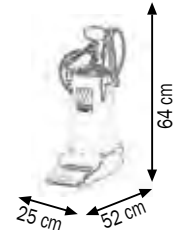

**016-1142-000**

**Art. 016-1142-000**

**Wheeled manual grease pump 16 kg**

**Outlet grease pressure 400 bar, 60 g delivery each 10 cycles of the lever**

Composed by:

Wheeled tank 16 kg

Art.014-1059-030 Follower plate Ø 220 mm with spring

Art.906-0142-020 1SC 1/4" hose F 1/4" - F 10X1 2.0 m length

Art.017-1155-000 Cock M-F 10x1 mm

Art.017-1156-000 200 mm rigid pipe and 4-jaws coupling



**016-1142-000** 14,300 0,090 1

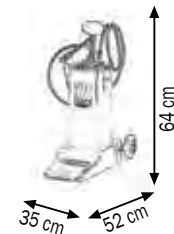
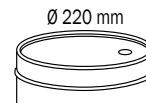

**016-1144-000**

**Art. 016-1144-000**

**Wheeled manual grease pedal pump 16 kg**

**Outlet grease pressure 400 bar, 40 g delivery each 10 cycles of the lever**

Composed by:

Wheeled tank 16 kg

Art.014-1059-012 Follower plate Ø 220 mm with spring

Art.906-0142-020 1SC 1/4" hose F 1/4" - F 10X1 2.0 m length

Art.017-1155-000 Cock M-F 10x1 mm

Art.017-1156-000 200 mm rigid pipe and 4-jaws coupling



**016-1144-000** 16,600 0,090 1

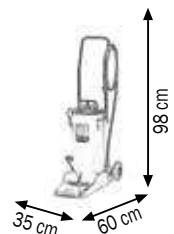
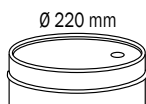

## Art. 016-1145-015

Manual grease pump for drums of 15 kg

Outlet grease pressure 400 bar, 60 g delivery each 10 cycles of the lever

Composed by:

Art.016-1158-000 Manual grease pump

Art.014-1050-030 Ø 280 mm drum lid

Art.014-1060-030 Follower plate Ø 265mm with spring

Art.906-0142-020 1SC 1/4" hose F 1/4" - F 10X1 2.0 m length

Art.017-1155-000 Cock M-F 10x1mm

Art.017-1156-000 200 mm rigid pipe and 4-jaws coupling



016-1145-015

## Art. 016-1145-C15

Wheeled manual grease pump for drums of 15 kg

Outlet grease pressure 400 bar, 60 g delivery each 10 cycles of the lever

Composed by:

Art.016-1158-000 Manual grease pump

Art.030-1392-000 2 wheels trolley

Art.014-1050-030 Ø 280 mm drum lid

Art.014-1060-030 Follower plate Ø 265mm with spring

Art.906-0142-020 1SC 1/4" hose F 1/4" - F 10X1 2.0 m length

Art.017-1155-000 Cock M-F 10x1mm

Art.017-1156-000 200 mm rigid pipe and 4-jaws coupling



016-1145-C15

016-1145-015	6,100	0,023	1
016-1145-C15	11,250	0,056	1

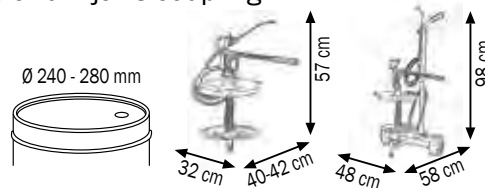

## Art. 016-1150-020

Manual grease pump for drums of 18-30 Kg

Outlet grease pressure 400 bar, 60 g delivery each 10 cycles of the lever

Composed by:

Art.016-1158-000 Manual grease pump

Art.014-1051-030 Ø 320 mm drum lid

Art.014-1062-030 Follower plate Ø 310mm with spring

Art.906-0142-020 1SC 1/4" hose F 1/4" - F 10X1 2.0 m length

Art.017-1155-000 Cock M-F 10x1mm

Art.017-1156-000 200 mm rigid pipe and 4-jaws coupling



016-1150-020

## Art. 016-1150-C20

Wheeled manual grease pump for drums of 18-30 kg

Outlet grease pressure 400 bar, 60 g delivery each 10 cycles of the lever

Composed by:

Art.016-1158-000 Manual grease pump

Art.030-1392-000 2 wheels trolley

Art.014-1051-030 Ø 320 mm drum lid

Art.014-1062-030 Follower plate Ø 310mm with spring

Art.906-0142-020 1SC 1/4" hose F 1/4" - F 10X1 2.0 m length

Art.017-1155-000 Cock M-F 10x1mm

Art.017-1156-000 200 mm rigid pipe and 4-jaws coupling



016-1150-C20

016-1150-020	6,550	0,023	1
016-1150-C20	17,750	0,056	1

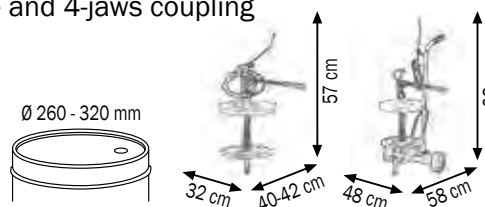



016-1150-050

## Art. 016-1150-050

Manual grease pump for drums of 50-60 kg.

Outlet grease pressure 400 bar, 60 g delivery each 10 cycles of the lever

Composed by:

Art.016-1158-A00 Manual grease pump

Art.014-1054-030 Ø 420 mm drum lid

Art.014-1065-030 Follower plate Ø 400mm with spring

Art.906-0142-020 1SC 1/4" hose F 1/4" - F 10X1 2.0 m length

Art.017-1155-000 Cock M-F 10x1mm

Art.017-1156-000 200 mm rigid pipe and 4-jaws coupling



016-1150-C50

## Art. 016-1150-C50

Wheeled manual grease pump for drums of 50-60 kg

Outlet grease pressure 400 bar, 60 g delivery each 10 cycles of the lever

Composed by:

Art.016-1158-A00 Manual grease pump

Art.030-1395-000 4 wheels trolley

Art.014-1054-030 Ø 420 mm drum lid

Art.014-1065-030 Follower plate Ø 400mm with spring

Art.906-0142-020 1SC 1/4" hose F 1/4" - F 10X1 2.0 m length

Art.017-1155-000 Cock M-F 10x1mm

Art.017-1156-000 200 mm rigid pipe and 4-jaws coupling



016-1150-050	10,800	0,056	1
016-1150-C50	22,800	0,056	1

Ø 370 - 420 mm

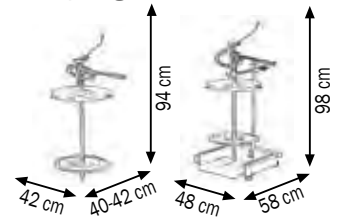

## ACCESSORIES FOR MANUAL GREASE PUMPS



017-1160-000

## Art. 017-1160-000

Adaptor coupler for filling valves Ø 14,7 and 9 mm

For manual grease pumps filling



017-1161-000

## Art. 017-1161-000

90° Rigid connection with adaptor Ø 14,7 and 9 mm

For manual grease pumps filling



906-0142-020

## Art. 906-0142-020

1SC 1/4" hose F 1/4" - F 10X1

2.0 m length

## Art. 906-0142-030

1SC 1/4" hose F 1/4" - F 10X1

3.0 m length



902-0414-020

## Art. 902-0414-020

R6 1/2" hose - M 1/2" - M 1/4"

2.0 m length

## Art. 016-1151-020

Manual transfer grease pump for drums of 18-30 kg  
Suitable for filling manual grease pumps, 400 g delivery each 10 cycles of the lever

Composed by:

- Art.016-1160-020 Manual transfer pump
- Art.014-1051-030 Ø 320 mm drum lid
- Art.014-1062-030 Follower plate Ø 310mm with spring
- Art.017-1161-000 Rigid connection 90° with adaptor Ø 9 mm



016-1151-020

## Art. 016-1151-C20

Wheeled manual transfer grease pump for drums of 18-30 kg  
Suitable for filling manual grease pumps, 400 g delivery each 10 cycles of the lever

Composed by:

- Art.016-1160-020 Manual transfer pump
- Art.030-1392-000 2 wheels trolley
- Art.014-1051-030 Ø 320 mm drum lid
- Art.014-1062-030 Follower plate Ø 310mm with spring
- Art.017-1161-000 Rigid connection 90° with adaptor Ø 9 mm



016-1151-C20

016-1151-020	6,350	0,023	1	
016-1151-C20	11,500	0,056	1	

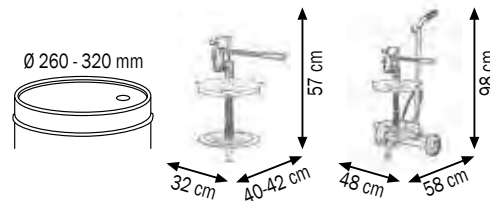

## Art. 016-1151-050

Manual transfer grease pump for drums of 50-60 kg  
Suitable for filling manual grease pumps, 400 g delivery each 10 cycles of the lever

Composed by:

- Art.016-1160-050 Manual transfer pump
- Art.014-1054-030 Ø 420 mm drum lid
- Art.014-1065-030 Follower plate Ø 400mm with spring
- Art.017-1161-000 Rigid connection 90° with adaptor Ø 9 mm



016-1151-050

## Art. 016-1151-C50

Wheeled manual transfer grease pump for drums of 50-60 kg  
Suitable for filling manual grease pumps, 400 g delivery each 10 cycles of the lever

Composed by:

- Art.016-1160-050 Manual transfer pump
- Art.030-1395-000 4 wheels trolley
- Art.014-1054-030 Ø 420 mm drum lid
- Art.014-1065-030 Follower plate Ø 400mm with spring
- Art.017-1161-000 Rigid connection 90° with adaptor Ø 9 mm



016-1151-C50

016-1151-050	10,700	0,790	1	
016-1151-C50	21,800	0,790	1	

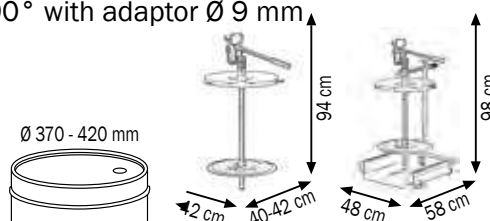



**016-1152-020**



## Art. 016-1152-020

Manual transfer grease pump for drums of 18-30 kg

Suitable for filling plants, 400 g delivery each 10 cycles of the lever

Composed by:

Art.016-1160-020 Manual transfer pump

Art.014-1051-030 Ø 320 mm drum lid

Art.014-1062-030 Follower plate Ø 310mm with spring

Art.902-0412-020 R6 1/2" hose 2,0 m length  
with level valve rigid end 30°

Art.F96-0500-002 Quick disconnect coupling F 1/4"

Art.F96-0502-002 Quick disconnect coupling M 1/4"



**016-1152-C20**



## Art. 016-1152-C20

Wheeled manual transfer grease pump for drums of 18-30 kg

Suitable for filling plants, 400 g delivery each 10 cycles of the lever

Composed by:

Art.016-1160-020 Manual transfer pump

Art.030-1392-000 2 wheels trolley

Art.014-1051-030 Ø 320 mm drum lid

Art.014-1062-030 Follower plate Ø 310mm with spring

Art.902-0412-020 R6 1/2" hose 2,0 m length  
with level valve rigid end 30°

Art.F96-0500-002 Quick disconnect coupling F 1/4"

Art.F96-0502-002 Quick disconnect coupling M 1/4"



Ø 260 - 320 mm

<b>016-1152-020</b>	7,400	0,023	1
<b>016-1152-C20</b>	12,500	0,056	1

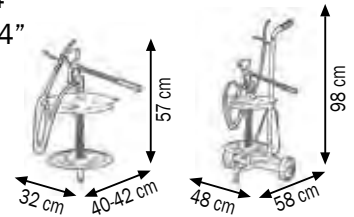

**016-1152-050**



## Art. 016-1152-050

Manual transfer grease pump for drums of 50-60 kg

Suitable for filling plants, 400 g delivery each 10 cycles of the lever

Composed by:

Art.016-1160-050 Manual transfer pump

Art.014-1054-030 Ø 420 mm drum lid

Art.014-1065-030 Follower plate Ø 400mm with spring

Art.902-0412-020 R6 1/2" hose 2,0 m length  
with level valve rigid end 30°

Art.F96-0500-002 Quick disconnect coupling F 1/4"

Art.F96-0502-002 Quick disconnect coupling M 1/4"



**016-1152-C50**



## Art. 016-1152-C50

Wheeled manual transfer grease pump for drums of 50-60 kg

Suitable for filling plants, 400 g delivery each 10 cycles of the lever

Composed by:

Art.016-1160-050 Manual transfer pump

Art.030-1395-000 4 wheels trolley

Art.014-1054-030 Ø 420 mm drum lid

Art.014-1065-030 Follower plate Ø 400mm with spring

Art.902-0412-020 R6 1/2" hose 2,0 m length  
with level valve rigid end 30°

Art.F96-0500-002 Quick disconnect coupling F 1/4"

Art.F96-0502-002 Quick disconnect coupling M 1/4"



Ø 370 - 420 mm

<b>016-1152-050</b>	11,700	0,790	1
<b>016-1152-C50</b>	22,800	0,790	1

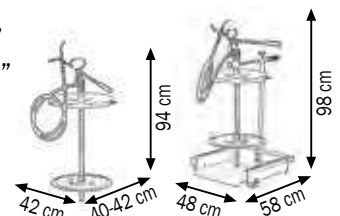

The air-operated oil pumps, fully designed and manufactured by MECLUBE, show remarkable operating features. They are fully made with electronic machine tools, the assembly is made with great care and the parts are carefully tested in order to assure the best guarantee of reliability and a long life. The type of used materials and manufacturing quality make these pumps suitable to work in the worst environment conditions.



The air-operated oil pumps, fully designed and manufactured by MECLUBE, show remarkable operating features. They are fully made with electronic machine tools, the assembly is made with great care and the parts are carefully tested in order to assure the best guarantee of reliability and a long life. The type of used materials and manufacturing quality make these pumps suitable to work in the worst environment conditions.

- **Brand new motion reverse device completely air operated, without cams**
- **Reduced number of worn parts**
- **Big amount of delivered oil with low air requirement**
- **High operating pressure**
- **Aluminum alloy body pump with electrolytic treatment that ensures very high corrosion strength**
- **High stressed elements in Fe 420 steel**



	AIR-OPERATED PUMPS FOR OIL AND SIMILAR FLUIDS	page 64
	OIL KITS	page 73
	DISPENSER BAR AND ACCESSORIES	page 89
	AIR-OPERATED INDUSTRIAL PUMPS FOR OIL AND SIMILAR FLUIDS	page 94
	ELECTRIC PUMPS KITS FOR OIL DISTRIBUTION	page 112
	DOUBLE-WALL TANKS FOR OIL "Multitank" AND "Tank in Tank"	page 114
	TANKS OF DUMP AND STOCKING SUITABLE FOR OIL-DISPENSING INSTALLATIONS	page 116
	FIXED INSTALLATIONS AND STRUCTURES	page 119
	NOZZLES FOR OIL AND SIMILAR FLUIDS	page 130
	ACCESSORIES FOR OIL PUMPS	page 140
	ELECTRONIC MANAGEMENT SYSTEMS	page 146
	PNEUMATIC AND MANUAL OIL DISPENSERS	page 156
	OIL SYRINGES, OIL CANS, DECANTERS AND FUNNELS	page 162
	AIR-OPERATED STAINLESS STEEL PUMPS FOR ANTI-FREEZE AND WINDSCREEN LIQUID	page 166
	BRAKE BLEEDERS-CLUTCHES ELECTRIC BRAKE BLEEDER	page 174

**Art. 020-0978-000**

**Air-operated oil pump Mod.501**  
ratio=1:1 Delivery capacity 35 l/min

For wall-fixing or fixed positions.  
With additional accessories it allows to make different applications.

Viton seals

**Art. 020-0980-000**

**Air-operated oil pump Mod.501**  
ratio=1:1 Delivery capacity 35 l/min

For standard drums of 50-60 l  
(shank length 740 mm)

Viton seals

**Art. 020-0985-000**

**Air-operated oil pump Mod.501**  
ratio=1:1 Delivery capacity 35 l/min

For standard drums of 180-220 l  
(shank length 940 mm)

Viton seals

**With threaded ring for drum connection.**



020-0978-000	4,100	0,007	1
020-0980-000	5,500	0,013	1
020-0985-000	6,200	0,016	1

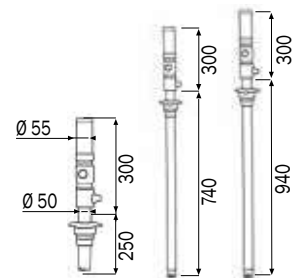

Technical Data		020-0978-000	020-0980-000	020-0985-000
Compression ratio		1:1	1:1	1:1
Working pressure	bar	6-8	6-8	6-8
Air consumption	l/min	200	200	200
Air inlet connection	BSP	F 1/4" G	F 1/4" G	F 1/4" G
Oil outlet connection	BSP	M 1/2" G	M 1/2" G	M 1/2" G
Oil delivery capacity 8 bar	l/min	35	35	35
Noise	dB	80	80	80
Shank diameter	mm	50	50	50
Shank length	mm	250	740	940
For drums with capacity of	l	-	50-60	180-220

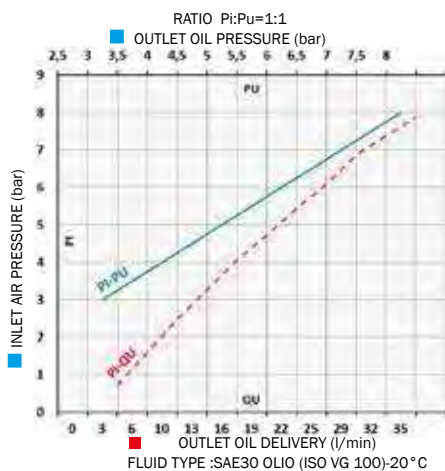

These pumps are advised for the transfer of low viscosity oil (SAE 15/80), similar fluids and antifreeze, for short distances (5 - 10 m). The delivery capacity of a pump varies according to particular applications and combinations: the pressure of air supplied; viscosity and temperature of the fluid; dimensions of delivery hose; dimensions of connections and type of gun which is used. The operating pressure may vary between a minimum of 3 bar and a maximum of 8 bar. To optimize the performance and the time-life of the air-operated pumps we advise to use filtered and lubricated air.

# AIR-OPERATED PUMPS FOR OIL AND SIMILAR FLUIDS Mod.503

**COMPRESSION RATIO = 3:1**

**DELIVERY CAPACITY = 25 l/min**



## Art. 020-0988-000

Air-operated oil pump Mod.503  
ratio=3:1 Delivery capacity 25 l/min

For wall-fixing or fixed positions.

With additional accessories it allows to make different applications.

Viton seals

## Art. 020-0990-000

Air-operated oil pump Mod.503  
ratio=3:1 Delivery capacity 25 l/min

For standard drums of 50-60 l

(shank length 740 mm)

Viton seals

## Art. 020-0995-000

Air-operated oil pump Mod.503  
ratio=3:1 Delivery capacity 25 l/min

For standard drums of 180-220 l

(shank length 940 mm)

Viton seals

## Art. 020-0995-125

Air-operated oil pump Mod.503  
ratio=3:1 Delivery capacity 25 l/min

For standard tanks of 750-1500 l

(shank length 1250 mm)

Viton seals

With threaded ring for drum connection.



020-0988-000	3,700	0,007	1
020-0990-000	5,000	0,013	1
020-0995-000	5,700	0,016	1
020-0995-125	6,700	0,019	1

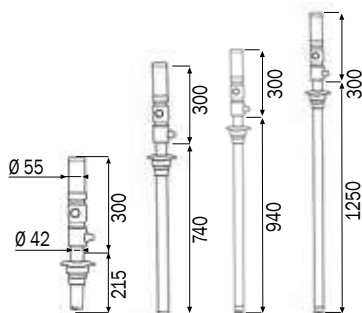

Technical Data		020-0988-000	020-0990-000	020-0995-000	020-0995-125
Compression ratio		3:1	3:1	3:1	3:1
Working pressure	bar	6-8	6-8	6-8	6-8
Air consumption	l/min	200	200	200	200
Air inlet connection	BSP	F 1/4" G	F 1/4" G	F 1/4" G	F 1/4" G
Oil outlet connection	BSP	M 1/2" G	M 1/2" G	M 1/2" G	M 1/2" G
Oil delivery capacity 8 bar	l/min	25	25	25	25
Noise	dB	80	80	80	80
Shank diameter	mm	42	42	42	42
Shank length	mm	215	740	940	1250
For drums with capacity of	l	-	50-60	180-220	750-1500

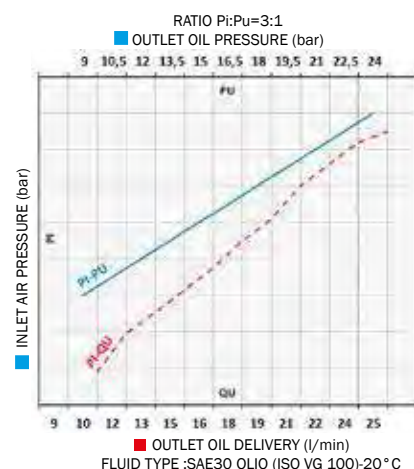

These pumps are advised for the transfer of low - medium viscosity oil (SAE 15/130), similar fluids and antifreeze, for short-medium distances (40 - 50 m). The delivery capacity of a pump varies according to particular applications and combinations: the pressure of air supplied; viscosity and temperature of the fluid; dimensions of delivery hose; dimensions of connections and type of gun which is used. The operating pressure may vary between a minimum of 3 bar and a maximum of 8 bar. To optimize the performance and the time-life of the air-operated pumps we advise to use filtered and lubricated air.



**Art. 020-1168-000**

**Air-operated oil pump Mod.601**  
ratio=1:1 Delivery capacity 40 l/min  
For wall-fixing or fixed positions.  
With additional accessories it allows to make different applications.  
**Polyurethane seals**

**Art. 020-1170-000**

**Air-operated oil pump Mod.601**  
ratio=1:1 Delivery capacity 40 l/min  
For standard drums of **180-220 l**  
(shank length 940 mm)  
**Polyurethane seals**

**Art. 020-1172-000**

**Air-operated oil pump Mod.601**  
ratio=1:1 Delivery capacity 40 l/min  
For standard tanks of **750-1500 l**  
(shank length 1250 mm)  
**Polyurethane seals**  
**With threaded ring for drum connection.**



<b>020-1168-000</b>	5,200	0,007	1
<b>020-1170-000</b>	7,300	0,016	1
<b>020-1172-000</b>	8,600	0,019	1

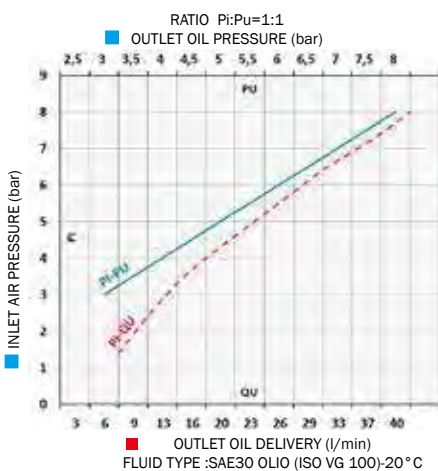
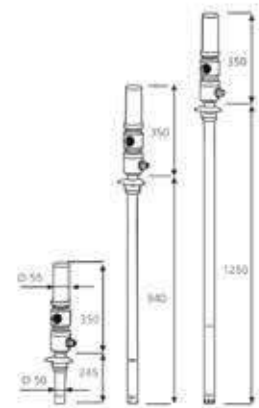

Technical Data	020-1168-000	020-1170-000	020-1172-000
Compression ratio	1:1	1:1	1:1
Working pressure	bar	6-8	6-8
Air consumption	l/min	220	220
Air inlet connection	BSP	F 1/4" G	F 1/4" G
Oil outlet connection	BSP	M 3/4" G	M 3/4" G
Oil delivery capacity 8 bar	l/min	40	40
Noise	dB	80	80
Shank diameter	mm	50	50
Shank length	mm	245	940
For drums with capacity of	l	-	180-220
			750-1500

These pumps are advised for the transfer of low viscosity oil (SAE 15/80), hydraulic oil, similar fluids and antifreeze, for short distances (5 - 10 m). The delivery capacity of a pump varies according to particular applications and combinations: the pressure of air supplied; viscosity and temperature of the fluid; dimensions of delivery hose; dimensions of connections and type of gun which is used. The operating pressure may vary between a minimum of 3 bar and a maximum of 8 bar. To optimize the performance and the time-life of the air-operated pumps we advise to use filtered and lubricated air.

# AIR-OPERATED OIL PUMPS Mod.603

**COMPRESSION RATIO = 3:1**

**DELIVERY CAPACITY = 30 l/min**



## Art. 020-1188-000

Double-acting air-operated oil pump Mod.603  
ratio=3:1 Delivery capacity 30 l/min

For wall-fixing or fixed positions.

With additional accessories it allows to make different applications.

Polyurethane seals

## Art. 020-1190-000

Double-acting air-operated oil pump Mod.603  
ratio=3:1 Delivery capacity 30 l/min

For standard drums of 50-60 l

(shank length 740 mm)

Polyurethane seals

## Art. 020-1195-000

Double-acting air-operated oil pump Mod.603  
ratio=3:1 Delivery capacity 30 l/min

For standard drums of 180-220 l

(shank length 940 mm)

Polyurethane seals

## Art. 020-1196-000

Double-acting air-operated oil pump Mod.603  
ratio=3:1 Delivery capacity 30 l/min

For standard tanks of 750-1500 l

(shank length 1250 mm)

Polyurethane seals

With threaded ring for drum connection.



Art. No.	Weight (Kg)	Volume (m³)	Box Qty
020-1188-000	5,300	0,007	1
020-1190-000	6,600	0,013	1
020-1195-000	7,200	0,016	1
020-1196-000	8,700	0,019	1

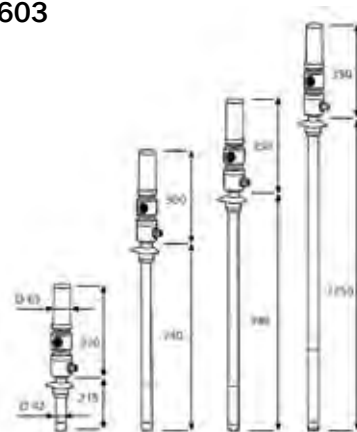

Technical Data		020-1188-000	020-1190-000	020-1195-000	020-1196-000
Compression ratio		3:1	3:1	3:1	3:1
Working pressure	bar	6-8	6-8	6-8	6-8
Air consumption	l/min	220	220	220	220
Air inlet connection	BSP	F 1/4" G	F 1/4" G	F 1/4" G	F 1/4" G
Oil outlet connection	BSP	M 1/2" G	M 1/2" G	M 1/2" G	M 1/2" G
Oil delivery capacity 8 bar	l/min	30	30	30	30
Noise	dB	80	80	80	80
Shank diameter	mm	42	42	42	42
Shank length	mm	215	740	940	1250
For drums with capacity of	l	-	50-60	180-220	750-1500

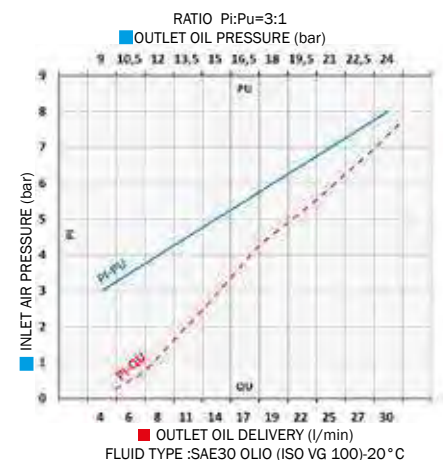

These pumps are advised for the transfer of low - medium viscosity oil (SAE 15/130), and anti-freeze, for short-medium distances (40 - 50 m). The delivery capacity of a pump varies according to particular applications and combinations: the pressure of air supplied; viscosity and temperature of the fluid; dimensions of delivery hose; dimensions of connections and type of gun which is used. The operating pressure may vary between a minimum of 3 bar and a maximum of 8 bar. The double-acting guarantees the delivery of a continuous and constant flow, suitable for installations on distribution facilities. To optimize the performance and the time-life of the air-operated pumps we advise to use filtered and lubricated air.

# AIR-OPERATED OIL PUMPS Mod.605

**COMPRESSION RATIO = 5:1**

**DELIVERY CAPACITY = 28 l/min**

## Art. 020-1198-000

Double-acting air-operated oil pump Mod.605  
ratio=5:1 Delivery capacity 28 l/min

For wall-fixing or fixed positions.

With additional accessories it allows to make different applications.

Polyurethane seals

## Art. 020-1200-000

Double-acting air-operated oil pump Mod.605  
ratio=5:1 Delivery capacity 28 l/min

For standard drums of 50-60 l

(shank length 740 mm)

Polyurethane seals

## Art. 020-1205-000

Double-acting air-operated oil pump Mod.605  
ratio=5:1 Delivery capacity 28 l/min

For standard drums of 180-220 l

(shank length 940 mm)

Polyurethane seals

## Art. 020-1206-000

Double-acting air-operated oil pump Mod.605  
ratio=5:1 Delivery capacity 28 l/min

For standard tanks of 750-1500 l

(shank length 1250 mm)

Polyurethane seals

With threaded ring for drum connection.



Art. No.	Weight (Kg)	Volume (m <sup>3</sup> )	Pressure (bar)
020-1198-000	5,500	0,007	1
020-1200-000	6,800	0,013	1
020-1205-000	7,400	0,016	1
020-1206-000	8,900	0,019	1

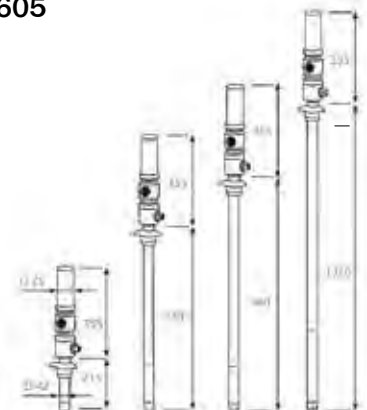

### Technical Data

	020-1198-000	020-1200-000	020-1205-000	020-1206-000
Compression ratio	5:1	5:1	5:1	5:1
Working pressure	bar	6-8	6-8	6-8
Air consumption	l/min	250	250	250
Air inlet connection	BSP	F 1/4" G	F 1/4" G	F 1/4" G
Oil outlet connection	BSP	M 1/2" G	M 1/2" G	M 1/2" G
Oil delivery capacity 8 bar	l/min	28	28	28
Noise	dB	80	80	80
Shank diameter	mm	42	42	42
Shank length	mm	215	740	940
For drums with capacity of	l	-	50-60	180-220
				750-1500

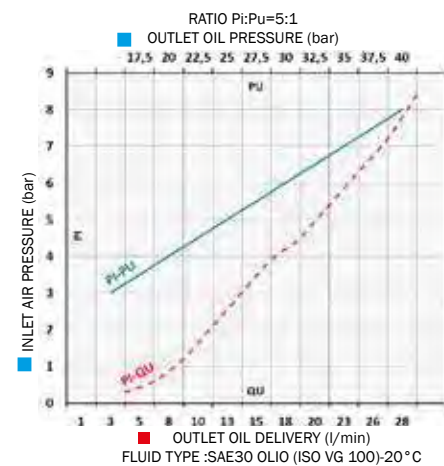

These pumps are advised for the transfer of medium-high viscosity oil (SAE 15/240), and anti-freeze, for medium-long distances (150 - 200 m). The delivery capacity of a pump varies according to particular applications and combinations: the pressure of air supplied; viscosity and temperature of the fluid; dimensions of delivery hose; dimensions of connections and type of gun which is used. The operating pressure may vary between a minimum of 3 bar and a maximum of 8 bar. The double-acting guarantees the delivery of a continuous and constant flow, suitable for installations on distribution facilities. To optimize the performance and the time-life of the air-operated pumps we advise to use filtered and lubricated air.

# AIR-OPERATED OIL PUMPS Mod.608

**COMPRESSION RATIO = 8:1**

**DELIVERY CAPACITY = 20 l/min**



## Art. 020-1207-000

**Double-acting air-operated oil pump Mod.608**

**ratio=8:1 Delivery capacity 20 l/min**

For wall-fixing or fixed positions.

With additional accessories it allows

to make different applications.

**Polyurethane seals**

## Art. 020-1208-000

**Double-acting air-operated oil pump Mod.608**

**ratio=8:1 Delivery capacity 20 l/min**

For standard drums of 50-60 l

(shank length 740 mm)

**Polyurethane seals**

## Art. 020-1210-000

**Double-acting air-operated oil pump Mod.608**

**ratio=8:1 Delivery capacity 20 l/min**

For standard drums of 180-220 l

(shank length 940 mm)

**Polyurethane seals**

## Art. 020-1211-000

**Double-acting air-operated oil pump Mod.608**

**ratio=8:1 Delivery capacity 20 l/min**

For standard tanks of 750-1500 l

(shank length 1250 mm)

**Polyurethane seals**

**With threaded ring for drum connection.**



Art. No.	Weight (Kg)	Volume (m³)	Box Qty
020-1207-000	4,900	0,007	1
020-1208-000	6,300	0,013	1
020-1210-000	7,000	0,016	1
020-1211-000	8,000	0,019	1

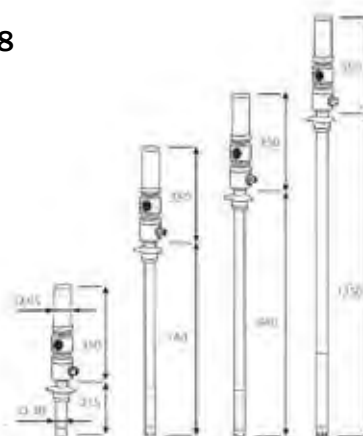

Technical Data		020-1207-000	020-1208-000	020-1210-000	020-1211-000
Compression ratio		8:1	8:1	8:1	8:1
Working pressure	bar	6-8	6-8	6-8	6-8
Air consumption	l/min	220	220	220	220
Air inlet connection	BSP	F 1/4" G	F 1/4" G	F 1/4" G	F 1/4" G
Oil outlet connection	BSP	M 1/2" G	M 1/2" G	M 1/2" G	M 1/2" G
Oil delivery capacity 8 bar	l/min	20	20	20	20
Noise	dB	80	80	80	80
Shank diameter	mm	30	30	30	30
Shank length	mm	215	740	940	1250
For drums with capacity of	l	-	50-60	180-220	750-1500

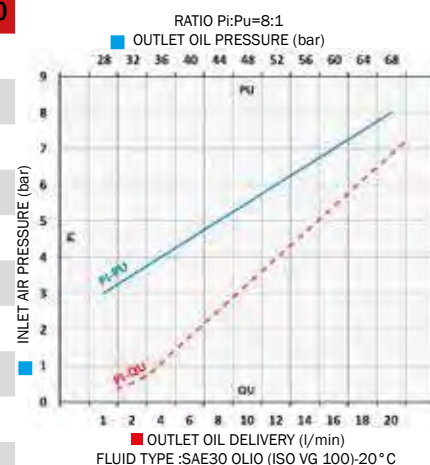

These pumps are advised for the transfer of high viscosity oil (SAE 15/280), for medium-long distances (150 – 200 m). The delivery capacity of a pump varies according to particular applications and combinations: the pressure of air supplied; viscosity and temperature of the fluid; dimensions of delivery hose; dimensions of connections and type of gun which is used. The operating pressure may vary between a minimum of 3 bar and a maximum of 8 bar. The double-acting guarantees the delivery of a continuous and constant flow, suitable for installations on distribution facilities. To optimize the performance and the time-life of the air-operated pumps we advise to use filtered and lubricated air.



**Art. 020-1176-000**  
**Double-acting air-operated oil pump Mod.803**  
**ratio=3:1 Delivery capacity 40 l/min**

For wall-fixing or fixed positions.  
 With additional accessories it allows to make different applications.  
**Polyurethane seals**

**Art. 020-1178-000**  
**Double-acting air-operated oil pump Mod.803**  
**ratio=3:1 Delivery capacity 40 l/min**

For standard drums of **180–220 l**  
 (shank length 940 mm)  
**Polyurethane seals**

**Art. 020-1179-000**  
**Double-acting air-operated oil pump Mod.803**  
**ratio=3:1 Delivery capacity 40 l/min**

For standard tanks of **750–1500 l**  
 (shank length 1250 mm)  
**Polyurethane seals**

**With threaded ring for drum connection.**

They are suitable for workshops oil distribution applications for industrial vehicles in which it is requested a high delivery with more dispensing points.



<b>020-1176-000</b>	10,100	0,011	1
<b>020-1178-000</b>	11,700	0,023	1
<b>020-1179-000</b>	12,600	0,028	1

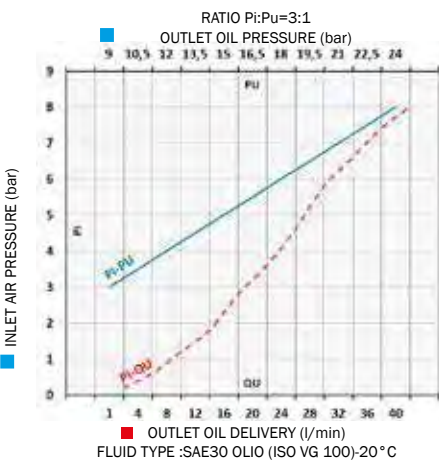
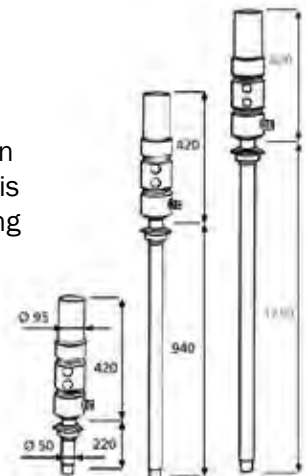

Technical Data	020-1176-000	020-1178-000	020-1179-000
Compression ratio	3:1	3:1	3:1
Working pressure	bar	6-8	6-8
Air consumption	l/min	340	340
Air inlet connection	BSP	F 3/8" G	F 3/8" G
Oil outlet connection	BSP	M 3/4" G	M 3/4" G
Oil delivery capacity 8 bar	l/min	40	40
Noise	dB	80	80
Shank diameter	mm	50	50
Shank length	mm	220	940
For drums with capacity of	l	-	180-220
			750-1500

These pumps are advised for the transfer of low-medium viscosity oil (SAE 15/130), and anti-freeze, for short-medium distances (40 – 50 m). The delivery capacity of a pump varies according to particular applications and combinations: the pressure of air supplied; viscosity and temperature of the fluid; dimensions of delivery hose; dimensions of connections and type of gun which is used. The operating pressure may vary between a minimum of 3 bar and a maximum of 8 bar. The double-acting guarantees the delivery of a continuous and constant flow, suitable for installations on distribution facilities. To optimize the performance and the time-life of the air-operated pumps we advise to use filtered and lubricated air.

# HIGH DELIVERY AIR-OPERATED OIL PUMPS Mod.805

COMPRESSION RATIO = 5:1

DELIVERY CAPACITY = 35 l/min



## Art. 020-1180-000

Double-acting air-operated oil pump Mod.805  
ratio=5:1 Delivery capacity 35 l/min

For wall-fixing or fixed positions.

With additional accessories it allows to make different applications.

Polyurethane seals

## Art. 020-1182-000

Double-acting air-operated oil pump Mod.805  
ratio=5:1 Delivery capacity 35 l/min

For standard drums of 180-220 l

(shank length 940 mm)

Polyurethane seals

## Art. 020-1183-000

Double-acting air-operated oil pump Mod.805  
ratio=5:1 Delivery capacity 35 l/min

For standard tanks of 750-1500 l

(shank length 1250 mm)

Polyurethane seals

With threaded ring for drum connection.

They are suitable for workshops oil distribution applications for industrial vehicles in which it is requested a high delivery with more dispensing points.



Art. No.	Weight (kg)	Volume (m³)	Quantity
020-1180-000	9,900	0,011	1
020-1182-000	11,300	0,023	1
020-1183-000	12,000	0,028	1

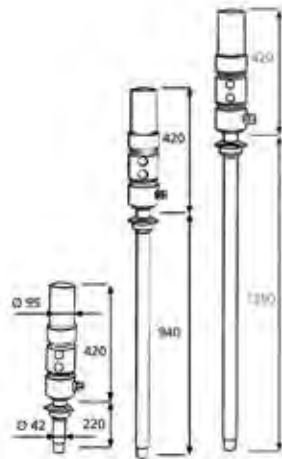

Technical Data		020-1180-000	020-1182-000	020-1183-000
Compression ratio		5:1	5:1	5:1
Working pressure	bar	6-8	6-8	6-8
Air consumption	l/min	385	385	385
Air inlet connection	BSP	F 3/8" G	F 3/8" G	F 3/8" G
Oil outlet connection	BSP	M 3/4" G	M 3/4" G	M 3/4" G
Oil delivery capacity 8 bar	l/min	35	35	35
Noise	dB	80	80	80
Shank diameter	mm	42	42	42
Shank length	mm	220	940	1250
For drums with capacity of	l	-	180-220	750-1500

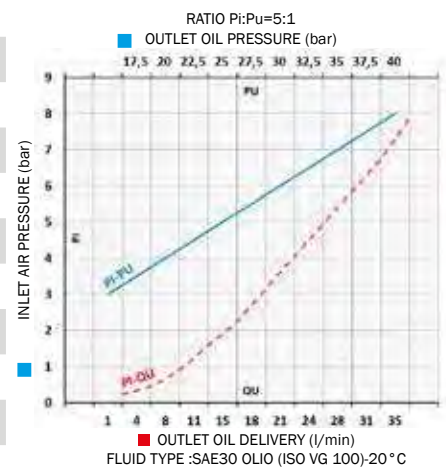

These pumps are advised for the transfer of medium-high viscosity oil (SAE 15/240) and anti-freeze, for medium-long distances (150 - 200 m). The delivery capacity of a pump varies according to particular applications and combinations: the pressure of air supplied; viscosity and temperature of the fluid; dimensions of delivery hose; dimensions of connections and type of gun which is used. The operating pressure may vary between a minimum of 3 bar and a maximum of 8 bar. The double-acting guarantees the delivery of a continuous and constant flow, suitable for installations on distribution facilities. To optimize the performance and the time-life of the air-operated pumps we advise to use filtered and lubricated air.



**Art. 020-1185-000**  
**Double-acting air-operated oil pump Mod.810**  
**ratio=10:1 Delivery capacity 30 l/min**

For wall-fixing or fixed positions.  
 With additional accessories it allows to make different applications.  
**Polyurethane seals**

**Art. 020-1186-000**  
**Double-acting air-operated oil pump Mod.810**  
**ratio=10:1 Delivery capacity 30 l/min**

For standard drums of **180-220 l**  
 (shank length 940 mm)  
**Polyurethane seals**

**Art. 020-1187-000**  
**Double-acting air-operated oil pump Mod.810**  
**ratio=10:1 Delivery capacity 30 l/min**

For standard tanks of **750-1500 l**  
 (shank length 1250 mm)  
**Polyurethane seals**

**With threaded ring for drum connection.**

They are suitable for workshops oil distribution applications for industrial vehicles in which it is requested a high delivery with more dispensing points.



<b>020-1185-000</b>	10,300	0,011	1
<b>020-1186-000</b>	11,600	0,023	1
<b>020-1187-000</b>	12,800	0,028	1

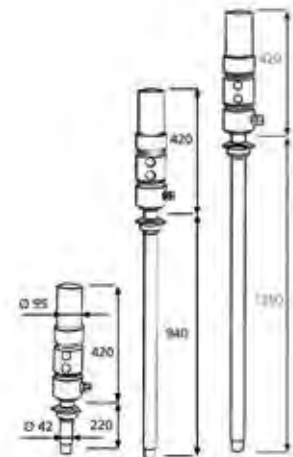

**Technical Data**      **020-1185-000**      **020-1186-000**      **020-1187-000**

Compression ratio		10:1	10:1	10:1
Working pressure	bar	6-8	6-8	6-8
Air consumption	l/min	385	385	385
Air inlet connection	BSP	F 3/8" G	F 3/8" G	F 3/8" G
Oil outlet connection	BSP	M 3/4" G	M 3/4" G	M 3/4" G
Oil delivery capacity 8 bar	l/min	30	30	30
Noise	dB	80	80	80
Shank diameter	mm	42	42	42
Shank length	mm	220	940	1250
For drums with capacity of	l	-	180-220	750-1500

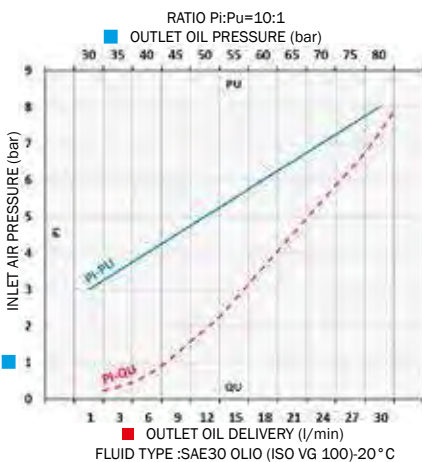

These pumps are advised for the transfer of medium-high viscosity oil (SAE 15/280) and anti-freeze, for medium-long distances (150 - 250 m). The delivery capacity of a pump varies according to particular applications and combinations: the pressure of air supplied; viscosity and temperature of the fluid; dimensions of delivery hose; dimensions of connections and type of gun which is used. The operating pressure may vary between a minimum of 3 bar and a maximum of 8 bar. The double-acting guarantees the delivery of a continuous and constant flow, suitable for installations on distribution facilities. To optimize the performance and the time-life of the air-operated pumps we advise to use filtered and lubricated air.

## Art. 022-1281-000

Oil kit suitable for drums of 50-60 l

Composed by:

Art.020-1200-000 Air-operated oil pump ratio=5:1 28 l/min

Art.906-0404-030 1SC 1/2" hose M-F 3,0 m length

Art.024-1233-C00 Oil digital dispensing nozzle

## Art. 022-1281-A00

Oil kit suitable for drums of 50-60 l

Composed like Art.022-1281-000 but with:

Art.020-1190-000 Air-operated oil pump ratio=3:1 30 l/min

## Art. 022-1281-B00

Oil kit suitable for drums of 50-60 l

Composed like Art.022-1281-000 but with:

Art.020-0990-000 Air-operated oil pump ratio=3:1 25 l/min

022-1281-000	10,400	0,034	2	
022-1281-A00	10,200	0,034	2	
022-1281-B00	8,600	0,034	2	

Ø 370-420 mm

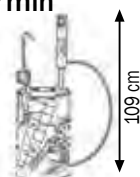

022-1281-000

## Art. 022-1288-000

Oil kit suitable for drums of 180-220 l

Composed by:

Art.020-1205-000 Air-operated oil pump ratio=5:1 28 l/min

Art.906-0404-030 1SC 1/2" hose M-F 3,0 m length

Art.024-1233-C00 Oil digital dispensing nozzle

## Art. 022-1288-A00

Oil kit suitable for drums of 180-220 l

Composed like Art.022-1288-000 but with:

Art.020-1195-000 Air-operated oil pump ratio=3:1 30 l/min

## Art. 022-1288-B00

Oil kit suitable for drums of 180-220 l

Composed like Art.022-1288-000 but with:

Art.020-0995-000 Air-operated oil pump ratio=3:1 25 l/min

022-1288-000	11,000	0,040	2	
022-1288-A00	10,800	0,040	2	
022-1288-B00	9,300	0,040	2	

Ø 550-600 mm

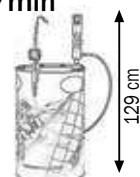

022-1288-000

## Art. 022-1289-000

Oil kit suitable for drums of 180-220 l

Composed by:

Art.020-1182-000 Air-operated oil pump ratio=5:1 35 l/min

Art.906-0505-030 1SC 3/4" hose M-F 3,0 m length

Art.024-1245-G00 High delivery oil digital dispensing nozzle

## Art. 022-1289-A00

Oil kit suitable for drums of 180-220 l

Composed like Art.022-1289-000 but with:

Art.020-1178-000 Air-operated oil pump ratio=3:1 40 l/min

022-1289-000	17,500	0,044	2	
022-1289-A00	17,900	0,044	2	

Ø 550-600 mm



022-1289-000



**022-1280-000**

**Art. 022-1280-000**

Wheeled oil kit suitable for drums of 50-60 l

Composed by:

Art.020-1200-000 Air-operated oil pump ratio=5:1 28 l/min

Art.030-1395-000 4-wheels trolley

Art.906-0404-030 1SC 1/2" hose M-F 3,0 m length

Art.024-1231-C00 Oil dispensing nozzle

**Art. 022-1282-000**

Wheeled oil kit suitable for drums of 50-60 l

Composed like Art.022-1280-000 but with:

Art.020-1190-000 Air-operated oil pump ratio=3:1 30 l/min

**Art. 022-1282-B00**

Wheeled oil kit suitable for drums of 50-60 l

Composed like Art.022-1280-000 but with:

Art.020-0990-000 Air-operated oil pump ratio=3:1 25 l/min



<b>022-1280-000</b>	22,800	0,085	2
<b>022-1282-000</b>	22,600	0,085	2
<b>022-1282-B00</b>	21,000	0,085	2

Ø 370-420 mm

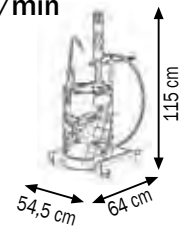

**022-1283-000**

**Art. 022-1283-000**

Wheeled oil kit suitable for drums of 50-60 l

Composed by:

Art.020-1200-000 Air-operated oil pump ratio=5:1 28 l/min

Art.030-1395-000 4-wheels trolley

Art.906-0404-030 1SC 1/2" hose M-F 3,0 m length

Art.024-1233-C00 Oil digital dispensing nozzle

**Art. 022-1284-000**

Wheeled oil kit suitable for drums of 50-60 l

Composed like Art.022-1283-000 but with:

Art.020-1190-000 Air-operated oil pump ratio=3:1 30 l/min

**Art. 022-1284-B00**

Wheeled oil kit suitable for drums of 50-60 l

Composed like Art.022-1283-000 but with:

Art.020-0990-000 Air-operated oil pump ratio=3:1 25 l/min



<b>022-1283-000</b>	23,400	0,085	2
<b>022-1284-000</b>	23,200	0,085	2
<b>022-1284-B00</b>	21,600	0,085	2

Ø 370-420 mm

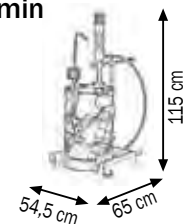

**022-1285-000**

**Art. 022-1285-000**

Wheeled oil kit suitable for drums of 180-220 l

Composed by:

Art.020-1205-000 Air-operated oil pump ratio=5:1 28 l/min

Art.030-1400-000 4-wheels trolley

Art.906-0404-030 1SC 1/2" hose M-F 3,0 m length

Art.024-1231-C00 Oil dispensing nozzle

**Art. 022-1287-000**

Wheeled oil kit suitable for drums of 180-220 l

Composed like Art.022-1285-000 but with:

Art.020-1195-000 Air-operated oil pump ratio=3:1 30 l/min



<b>022-1285-000</b>	46,600	0,186	2
<b>022-1287-000</b>	46,400	0,186	2

Ø 550-600 mm

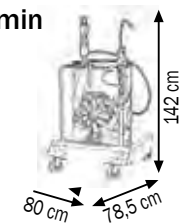

## Art. 022-1290-000

Wheeled oil kit suitable for drums of 180-220 l

Composed by:

Art.020-1205-000 Air-operated oil pump ratio=5:1 28 l/min

Art.030-1400-000 4-wheels trolley

Art.906-0404-030 1SC 1/2" hose M-F 3,0 m length

Art.024-1233-C00 Oil digital dispensing nozzle

## Art. 022-1292-000

Wheeled oil kit suitable for drums of 180-220 l

Composed like Art.022-1290-000 but with:

Art.020-1195-000 Air-operated oil pump ratio=3:1 30 l/min

				Ø 550-600 mm	
022-1290-000	47,300	0,186	2		142 cm
022-1292-000	47,100	0,186	2		80 cm
					78,5 cm



022-1290-000

## Art. 022-1293-000

Wheeled oil kit suitable for drums of 180-220 l

Composed by:

Art.020-1205-000 Air-operated oil pump ratio=5:1 28 l/min

Art.030-1405-000 4-wheels trolley

Art.906-0404-030 1SC 1/2" hose M-F 3,0 m length

Art.024-1233-C00 Oil digital dispensing nozzle

## Art. 022-1294-000

Wheeled oil kit suitable for drums of 180-220 l

Composed like Art.022-1293-000 but with:

Art.020-1195-000 Air-operated oil pump ratio=3:1 30 l/min

				Ø 550-600 mm	
022-1293-000	56,500	0,186	2		142 cm
022-1294-000	56,300	0,186	2		80 cm
					97 cm



022-1293-000

## Art. 022-1295-000

Wheeled oil kit suitable for drums of 180-220 l

Composed by:

Art.020-1205-000 Air-operated oil pump ratio=5:1 28 l/min

Art.030-1405-000 4-wheels trolley

Art.906-0424-015 1SC 1/2" hose F-F 1,5 m length

Art.070-1206-410 Hose reel with 1SC 1/2" hose 10,0 m length

Art.024-1233-C00 Oil digital dispensing nozzle

## Art. 022-1297-000

Wheeled oil kit suitable for drums of 180-220 l

Composed like Art.022-1295-000 but with:

Art.020-1195-000 Air-operated oil pump ratio=3:1 30 l/min

				Ø 550-600 mm	
022-1295-000	72,900	0,226	3		142 cm
022-1297-000	72,700	0,226	3		80 cm
					97 cm



022-1295-000



**022-1298-A00**

### Art. 022-1298-A00

Wheeled oil kit suitable for drums of 180-220 l

Composed by:

Art.020-1205-000 Air-operated oil pump ratio=5:1 28 l/min

Art.030-1398-000 3-wheels trolley

Art.906-0404-030 1SC 1/2" hose M-F 3,0 m length

Art.024-1231-C00 Oil dispensing nozzle

### Art. 022-1298-B00

Wheeled oil kit suitable for drums of 180-220 l

Composed like Art.022-1298-A00 but with:

Art.020-1195-000 Air-operated oil pump ratio=3:1 30 l/min



022-1298-A00	31,500	0,186	2
022-1298-B00	31,300	0,186	2

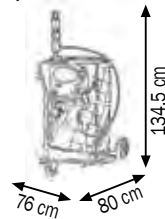
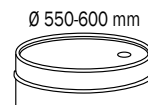

**022-1298-C00**

### Art. 022-1298-C00

Wheeled oil kit suitable for drums of 180-220 l

Composed by:

Art.020-1205-000 Air-operated oil pump ratio=5:1 28 l/min

Art.030-1398-000 3-wheels trolley

Art.906-0404-030 1SC 1/2" hose M-F 3,0 m length

Art.024-1233-C00 Oil digital dispensing nozzle

### Art. 022-1298-D00

Wheeled oil kit suitable for drums of 180-220 l

Composed like Art.022-1298-C00 but with:

Art.020-1195-000 Air-operated oil pump ratio=3:1 30 l/min



022-1298-C00	32,300	0,186	2
022-1298-D00	32,000	0,186	2

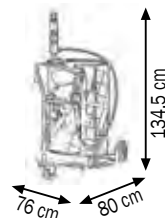
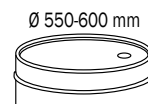

**022-1298-E00**

### Art. 022-1298-E00

Wheeled oil kit suitable for drums of 180-220 l

Composed by:

Art.020-1205-000 Air-operated oil pump ratio=5:1 28 l/min

Art.030-1398-000 3-wheels trolley

Art.906-0424-015 1SC 1/2" hose F-F 1,5 m length

Art.070-1206-410 Hose reel with 1SC 1/2" hose 10,0 m length

Art.024-1233-C00 Oil digital dispensing nozzle

### Art. 022-1298-F00

Wheeled oil kit suitable for drums of 180-220 l

Composed like Art.022-1298-E00 but with:

Art.020-1195-000 Air-operated oil pump ratio=3:1 30 l/min



022-1298-E00	48,500	0,226	3
022-1298-F00	48,300	0,226	3

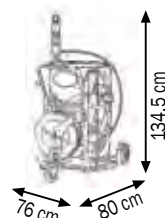
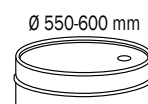

## Art. 022-1299-A00

Wheeled oil kit suitable for drums of 180-220 l

Composed by:

Art.020-0995-000 Air-operated oil pump ratio=3:1 25 l/min

Art.030-1398-000 3-wheels trolley

Art.906-0404-030 1SC 1/2" hose M-F 3,0 m length





Art.024-1231-C00 Oil dispensing nozzle

## Art. 022-1299-B00

Wheeled oil kit suitable for drums of 180-220 l

Composed like Art.022-1299-A00 but with:

Art.020-0985-000 Air-operated oil pump ratio=1:1 35 l/min

			
022-1299-A00	29,800	0,186	2
022-1299-B00	30,300	0,186	2

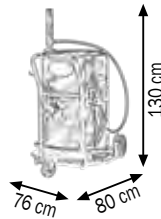
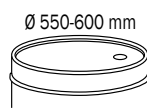

022-1299-A00

## Art. 022-1299-C00

Wheeled oil kit suitable for drums of 180-220 l

Composed by:

Art.020-0995-000 Air-operated oil pump ratio=3:1 25 l/min

Art.030-1398-000 3-wheels trolley

Art.906-0404-030 1SC 1/2" hose M-F 3,0 m length





Art.024-1233-C00 Oil digital dispensing nozzle

## Art. 022-1299-D00

Wheeled oil kit suitable for drums of 180-220 l

Composed like Art.022-1299-C00 but with:

Art.020-0985-000 Air-operated oil pump ratio=1:1 35 l/min

			
022-1299-C00	30,500	0,186	2
022-1299-D00	31,000	0,186	2

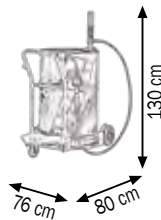
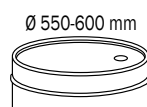

022-1299-C00

## Art. 022-1299-E00

Wheeled oil kit suitable for drums of 180-220 l

Composed by:

Art.020-0995-000 Air-operated oil pump ratio=3:1 25 l/min

Art.030-1398-000 3-wheels trolley

Art.906-0424-015 1SC 1/2" hose F-F 1,5 m length

Art.070-1206-410 Hose reel with 1SC 1/2" M-F hose 10,0 m length





Art.024-1233-C00 Oil digital dispensing nozzle

## Art. 022-1299-F00

Wheeled oil kit suitable for drums of 180-220 l

Composed like Art.022-1299-E00 but with:

Art.020-0985-000 Air-operated oil pump ratio=1:1 35 l/min

			
022-1299-E00	46,800	0,226	3
022-1299-F00	47,300	0,226	3

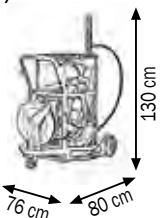

022-1299-E00

## WHEELED OIL KITS WITH AIR-OPERATED DOUBLE DIAPHRAGM PUMP



**022-2000-055**

### Art. 022-2000-055

Wheeled oil kit with air-operated diaphragm pump for drums 180-220 l

Composed by:

Art.028-A055-TB1 Aluminium air-op. diaphragm pump **R=1:1 1/2" 55 l/min** with:  
Suction hose with brass foot valve, threaded ring 940 mm l

Art.030-1398-000 3-wheels trolley

Art.906-0404-030 1SC 1/2" hose M-F lenght 3,0 m

Art.024-1233-C00 Oil digital dispensing nozzle

Art.F96-0100-404 Nipple 1/2" M-1/2" M BSP



Ø 550-600 mm

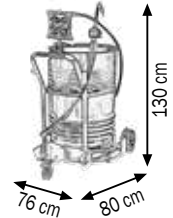

**022-2000-055** 31,600 0,233 2



**022-2000-110**

### Art. 022-2000-110

Wheeled oil kit with air-operated diaphragm pump for drums 180-220 l

Composed by:

Art.028-A110-TB1 Aluminium air-op. diaphragm pump **R=1:1 3/4" 110 l/min** with:  
Suction hose with brass foot valve, threaded ring 940 mm l

Art.030-1398-000 3-wheels trolley

Art.906-0505-030 1SC 3/4" hose M-F lenght 3,0 m

Art.024-1245-G00 Oil digital dispensing nozzle

Art.F96-0100-505 Nipple 3/4 M- 3/4" M BSP



Ø 550-600 mm

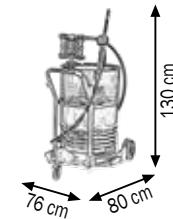

**022-2000-110** 36,000 0,233 2



**022-2010-110**

### Art. 022-2010-110

Wheeled oil kit with air-operated diaphragm pump for drums 180-220 l

Composed by:

Art.028-A110-AB1 Aluminium air-op. diaphragm pump **R=1:1 3/4" 110 l/min**

Art.030-1398-000 3-wheels trolley

Art.025-1270-094 Shank hose kit l 940 mm+flex 2m + threaded ring

Art.R18-0855-255 Brass connection fixed rubber M3/4" Ø 25 mm

Art.906-0505-030 1SC 3/4" hose M-F lenght 3,0 m

Art.024-1245-G00 Oil digital dispensing nozzle

Art.F96-0100-505 Nipple 3/4 M- 3/4" M BSP



Ø 550-600 mm

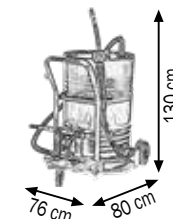

**022-2010-110** 38,300 0,276 3



**022-2010-170**

### Art. 022-2010-170

Wheeled oil kit with air-operated diaphragm pump for drums 180-220 l

Composed by:

Art.028-A170-AB1 Aluminium air-op. diaphragm pump **R=1:1 1" 170 l/min**

Art.030-1398-000 3-wheels trolley

Art.025-1270-094 Shank hose kit l 940 mm+flex 2m + threaded ring

Art.R18-0855-256 Brass connection fixed rubber M1" Ø 25 mm

Art.906-0505-030 1SC 3/4" hose M-F lenght 3,0 m

Art.024-1245-G00 Oil digital dispensing nozzle

Art.F96-0100-605 Nipple 1" M - 3/4" M BSP



Ø 550-600 mm

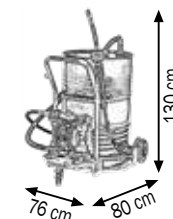
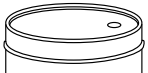

**022-2010-170** 50,600 0,283 3

## Art. 022-1213-A00

### Wall-fixing oil kit for drums of 180-220 l

Composed by:

Art.020-0988-000 Air-operated oil pump **ratio=3:1 25 l/min**

Art.025-1265-000 Wall-fixing bracket

Art.025-1268-094 Ø 42 mm suction tube 940 mm length

Art.025-1262-000 Ø 42 mm threaded ring

Art.910-0600-020 Flexible hose Ø 25 2,0 m length

Art.B27-1132-035 N.2 stainless steel screw clamps 32-35 mm

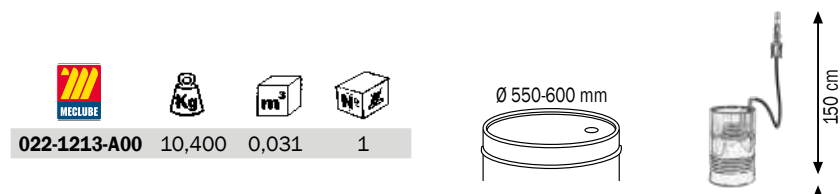

022-1213-A00	10,400	0,031	1



022-1213-A00

## Art. 022-1213-000

### Wall-fixing oil kit for drums of 180-220 l

Composed by:

Art.020-1188-000 Double-acting air-operated oil pump **ratio=3:1 30 l/min**

Art.025-1265-000 Wall-fixing bracket

Art.025-1268-094 Ø 42 mm suction tube 940 mm length

Art.025-1262-000 Ø 42 mm threaded ring

Art.910-0600-020 Flexible hose Ø 25 2,0 m length

Art.B27-1132-035 N.2 stainless steel screw clamps 32-35 mm

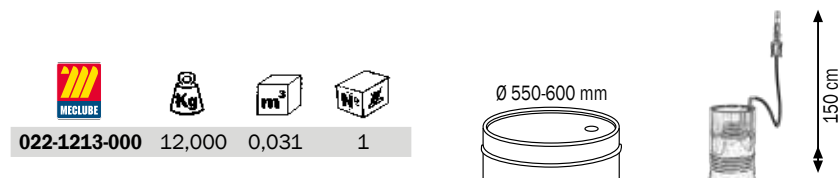

022-1213-000	12,000	0,031	1



022-1213-000

## Art. 022-1214-000

### Wall-fixing HIGH DELIVERY oil kit for drums and tanks 700 - 1.000 l

Composed by:

Art.020-1176-000 Double-acting air-operated oil pump **ratio=3:1 40 l/min**

Art.025-1265-000 Wall-fixing bracket

Art.025-1268-125 Ø 42 mm suction tube 1250 mm length

Art.025-1262-000 Ø 42 mm threaded ring

Art.910-0600-020 Flexible hose Ø 25 2,0 m length

Art.B27-1132-035 N.2 stainless steel screw clamps 32-35 mm

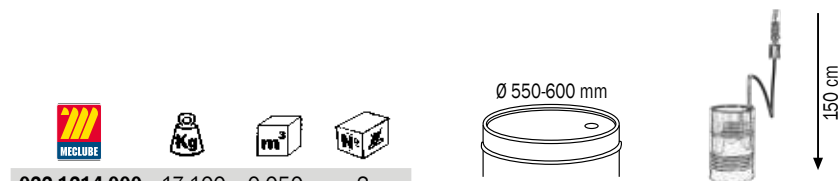

022-1214-000	17,100	0,050	2



022-1214-000

## Art. 022-1215-000

Wall-fixing oil kit for drums of 180-220 l

Composed by:

Art.020-1198-000 Double-acting air-operated oil pump **ratio=5:1 28 l/min**

Art.025-1265-000 Wall-fixing bracket

Art.025-1268-094 Ø 42 mm suction tube 940 mm lenght

Art.025-1262-000 Ø 42 mm threaded ring

Art.910-0600-020 Flexible hose Ø 25 2,0 m length

Art.B27-1132-035 N.2 stainless steel screw clamps 32-35 mm

## Art. 022-1218-000

Wall-fixing oil kit for drums of 180-220 l

Composed like Art.022-1215-000 but with:

Art.020-1207-000 Double-acting air-operated oil pump **ratio=8:1 20 l/min**



022-1215-000



Ø 550-600 mm

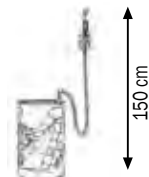

022-1215-000	12,200	0,031	1
022-1218-000	11,600	0,031	1

## Art. 022-1216-000

Wall-fixing HIGH DELIVERY oil kit for drums and tanks 700 - 1.000 l

Composed by:

Art.020-1180-000 Double-acting air-operated oil pump **ratio=5:1 35 l/min**

Art.025-1265-000 Wall-fixing bracket

Art.025-1268-125 Ø 42 mm suction tube 1250 mm lenght

Art.025-1262-000 Ø 42 mm threaded ring

Art.910-0600-020 Flexible hose Ø 25 2,0 m length

Art.B27-1132-035 N.2 stainless steel screw clamps 32-35 mm



022-1216-000



Ø 550-600 mm



022-1216-000	16,900	0,031	2
--------------	--------	-------	---

## Art. 022-1217-000

Wall-fixing HIGH DELIVERY oil kit for drums and tanks 700 - 1.000 l

Composed by:

Art.020-1185-000 Double-acting air-operated oil pump **ratio=10:1 30 l/min**

Art.025-1265-000 Wall-fixing bracket

Art.025-1268-125 Ø 42 mm suction tube 1250 mm lenght

Art.025-1262-000 Ø 42 mm threaded ring

Art.910-0600-020 Flexible hose Ø 25 2,0 m length

Art.B27-1132-035 N.2 stainless steel screw clamps 32-35 mm



022-1217-000



Ø 550-600 mm

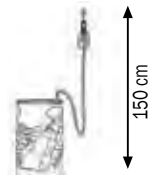

022-1217-000	17,300	0,031	2
--------------	--------	-------	---

## Art. 022-1301-A10

Wall-fixing oil kit for drums of 180-220 l

Composed by:

- Art.020-0995-000 Air-operated oil pump ratio=3:1 25 l/min
- Art.070-1206-410 Fixed hose reel with 1SC 1/2" hose 10,0 m l
- Art.906-0424-015 1SC 1/2" hose F-F1,5 m length
- Art.024-1233-C00 Oil digital dispensing nozzle

## Art. 022-1301-A15

Wall-fixing oil kit for drums of 180-220 l

Composed like Art.022-1301-A10 but with:

- Art.070-1306-415 Fixed hose reel with 1SC 1/2" hose 15,0 m l

022-1301-A10	25,700	0,127	3	
022-1301-A15	30,900	0,137	3	

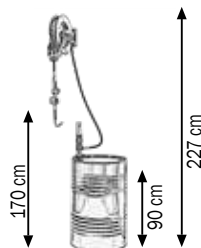
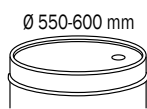

022-1301-A10

## Art. 022-1301-C10

Wall-fixing oil kit for drums of 180-220 l

Composed by:

- Art.020-0995-000 Air-operated oil pump ratio=3:1 25 l/min
- Art.074-4506-410 Fixed closed hose reel with 1SC 1/2" hose 10,0 m l
- Art.906-0424-015 1SC 1/2" hose F-F 1,5 m length
- Art.024-1233-C00 Oil digital dispensing nozzle

## Art. 022-1301-C15

Wall-fixing oil kit for drums of 180-220 l

Composed like Art.022-1301-C10 but with:

- Art.074-4506-415 Fixed closed hose reel with 1SC 1/2" hose 15,0 m l

022-1301-C10	34,500	0,127	3	
022-1301-C15	37,600	0,137	3	

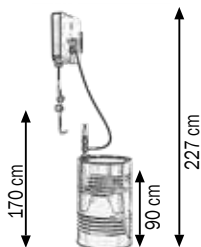
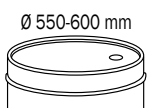

022-1301-C10



**022-1301-000**

### Art. 022-1301-000

Wall-fixing oil kit for drums of 180–220 l

Composed by:

Art.020-1195-000 Air-operated oil pump **ratio=3:1 30 l/min**

Art.071-1206-410 Swiveling hose reel with 1SC 1/2" hose 10,0 m l

Art.906-0424-015 1SC 1/2" hose F-F 1,5 m length

Art.024-1233-C00 Oil digital dispensing nozzle





Art.024-1785-000 Support for drops collection

### Art. 022-1300-000

Wall-fixing oil kit for drums of 180–220 l

Composed like Art.022-1301-000 but with:

Art.020-1205-000 Air-operated oil pump **ratio=5:1 28 l/min**

				
<b>022-1301-000</b>	33,800	0,164	4	
<b>022-1300-000</b>	34,000	0,164	4	

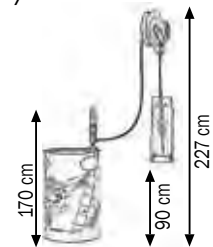
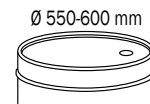

**022-1301-C00**

### Art. 022-1301-C00

Wall-fixing oil kit for drums of 180–220 l

Composed by:

Art.020-1195-000 Air-operated oil pump **ratio=3:1 30 l/min**

Art.075-4506-410 Swiveling closed hose reel with 1SC 1/2" hose 10,0 m l

Art.906-0424-015 1SC 1/2" hose F-F 1,5 m length

Art.024-1233-C00 Oil digital dispensing nozzle





Art.024-1785-000 Support for drops collection

### Art. 022-1300-C00

Wall-fixing oil kit for drums of 180–220 l

Composed like Art.022-1301-C00 but with:

Art.020-1205-000 Air-operated oil pump **ratio=5:1 28 l/min**

				
<b>022-1301-C00</b>	42,000	0,164	4	
<b>022-1300-C00</b>	42,200	0,164	4	

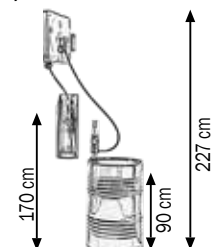
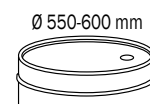

## Art. 022-1303-000

Wall-fixing oil kit for drums of 180-220 l

Composed by:

Art.020-1188-000 Air-operated oil pump ratio=3:1 30 l/min

Art.025-1265-000 Wall-fixing bracket

Art.025-1268-094 Ø 42 mm suction tube 940 mm length

Art.025-1262-000 Ø 42 mm threaded ring

Art.910-0600-020 Flexible hose Ø 25 2,0 m length

Art.B27-1132-035 N.2 stainless steel screw clamps 32-35 mm

Art.071-1206-410 Swiveling hose reel with 1SC 1/2" hose 10,0 m l

Art.906-0434-008 1SC 1/2" hose F90° - F 0,8 m length

Art.024-1233-C00 Oil digital dispensing nozzle

Art.024-1785-000 Support for drops collection



022-1303-000

## Art. 022-1302-000

Wall-fixing oil kit for drums of 180-220 l

Composed like Art.022-1303-000 but with:

Art.020-1198-000 Air-operated oil pump kit ratio=5:1 28 l/min

022-1303-000	38,300	0,215	5	
022-1302-000	38,500	0,215	5	

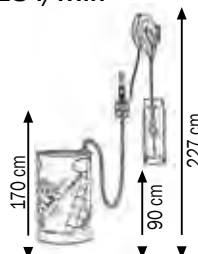
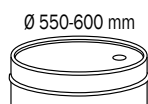

## Art. 022-1303-C00

Wall-fixing oil kit for drums of 180-220 l

Composed by:

Art.020-1188-000 Air-operated oil pump ratio=3:1 30 l/min

Art.025-1265-000 Wall-fixing bracket

Art.025-1268-094 Ø 42 mm suction tube 940 mm length

Art.025-1262-000 Ø 42 mm threaded ring

Art.910-0600-020 Flexible hose Ø 25 2,0 m length

Art.B27-1132-035 N.2 stainless steel screw clamps 32-35 mm

Art.075-4506-410 Swiveling closed hose reel with 1SC 1/2" hose 10,0 m l

Art.906-0434-008 1SC 1/2" hose F90° - F 0,8 m length

Art.024-1233-C00 Oil digital dispensing nozzle

Art.024-1785-000 Support for drops collection



022-1302-C00

## Art. 022-1302-C00

Wall-fixing oil kit for drums of 180-220 l

Composed like Art.022-1303-C00 but with:

Art.020-1198-000 Air-operated oil pump kit ratio=5:1 28 l/min

022-1303-C00	46,600	0,215	5	
022-1302-C00	46,600	0,215	5	

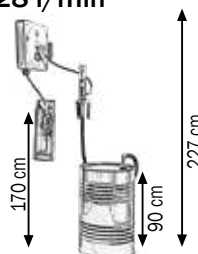
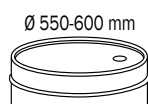



**022-1313-515**

## Art. 022-1313-515

Wall-fixing HIGH DELIVERY oil kit for drums of 180-220 l and tanks of 700-1000 l

Composed by:

Art.020-1176-000 Air-operated oil pump ratio=3:1 40 l/min

Art.025-1265-000 Wall-fixing bracket

Art.025-1268-125 Ø 42 mm suction tube 1250 mm length

Art.025-1262-000 Ø 42 mm threaded ring

Art.910-0600-020 Flexible hose Ø 25 2,0 m length

Art.B27-1132-035 N.2 stainless steel screw clamps 32-35 mm

Art.071-1406-515 Swiveling hose reel with 1SC 3/4" hose 15,0 m l

Art.906-0535-008 1SC 3/4" hose F90° - F 0,8 m length

Art.024-1245-G00 High delivery oil digital dispensing nozzle

Art.024-1785-000 Support for drops collection



**022-1313-515** 62,900 0,233 4

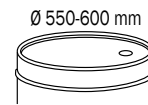

Ø 550-600 mm

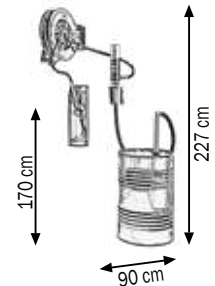

**022-1315-515**

## Art. 022-1315-515

Wall-fixing HIGH DELIVERY oil kit for drums of 180-220 l and tanks of 700-1000 l

Composed by:

Art.020-1180-000 Air-operated oil pump ratio=5:1 35 l/min

Art.025-1265-000 Wall-fixing bracket

Art.025-1268-125 Ø 42 mm suction tube 1250 mm length

Art.025-1262-000 Ø 42 mm threaded ring

Art.910-0600-020 Flexible hose Ø 25 2,0 m length

Art.B27-1132-035 N.2 stainless steel screw clamps 32-35 mm

Art.071-1406-515 Swiveling hose reel with 1SC 3/4" hose 15,0 m l

Art.906-0535-008 1SC 3/4" hose F90° - F 0,8 m length

Art.024-1245-G00 High delivery oil digital dispensing nozzle

Art.024-1785-000 Support for drops collection

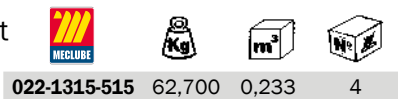

**022-1315-515** 62,700 0,233 4

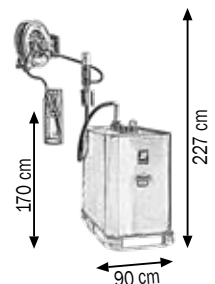

The tank is not included in the oil kit

## Art. 022-1880-000

### Wall-fixing oil kit for IBC tanks 1000 l

Composed by:

- Art.020-1198-000 Air-operated oil pump **ratio=5:1 28 l/min**
- Art.014-1048-000 Regulator with filter and air lubricator 1/4"
- Art.025-1265-000 Wall-fixing bracket
- Art.025-1268-125 Ø 42 mm suction tube 1250 mm length
- Art.025-1262-000 Ø 42 mm threaded ring
- Art.910-0600-020 Flexible hose Ø 25 2,0 m length
- Art.B27-1132-035 N.2 stainless steel screw clamps 32-35 mm
- Art.906-0434-008 1SC 1/2" hose F90° - F 0,8 m length
- Art.902-0202-020 R6 5/16" Hose 1/4" M-F 2,0 m length
- Art.F96-0100-404 Nipple 1/2" M-1/2" M
- Art.025-1267-000 Tank-fixing bracket



**022-1880-000**

The tank is not included in the oil kit

## Art. 022-1882-000

### Wall-fixing oil kit for IBC tanks 1000 l

Composed like Art.022-1880-000 but with:

- Art.020-1188-000 Air-operated oil pump **ratio=3:1 30 l/min**

<b>022-1880-000</b>	25,600	0,031	3
<b>022-1882-000</b>	25,400	0,031	3



## Art. 022-1884-000

### Wall-fixing HIGH DELIVERY oil kit for IBC tanks 1000 l

Composed by:

- Art.020-1180-000 Air-operated oil pump **ratio=5:1 35 l/min**
- Art.014-1048-B00 Regulator with filter and air lubricator 1/2"
- Art.025-1265-000 Wall-fixing bracket
- Art.025-1268-125 Ø 42 mm suction tube 1250 mm length
- Art.025-1262-000 Ø 42 mm threaded ring
- Art.910-0600-020 Flexible hose Ø 25 2,0 m length
- Art.B27-1132-035 N.2 stainless steel screw clamps 32-35 mm
- Art.906-0535-008 1SC 3/4" hose F90° - F 0,8 m length
- Art.902-0424-020 R6 1/2" Hose 1/2" F-F 2,0 m length
- Art.F96-0100-404 Nipple 1/2 M - 1/2 M
- Art.F96-0100-505 Nipple 3/4" M-3/4" M
- Art.025-1267-000 Tank-fixing bracket



**022-1884-000**

The tank is not included in the oil kit

## Art. 022-1886-000

### Wall-fixing HIGH DELIVERY oil kit for IBC tanks 1000 l

Composed like Art.022-1884-000 but with:

- Art.020-1176-000 Air-operated oil pump **ratio=3:1 40 l/min**

<b>022-1884-000</b>	31,200	0,031	3
<b>022-1886-000</b>	31,400	0,031	3



It is a modular solution that allows the oil delivery with connection to a centralized system, to a hose reel or directly to the delivery hose.



**022-1888-000**

**Art. 022-1888-000**

**Oil kit for IBC tanks 1000 l**

Composed by:

- Art.020-1206-000 Air-operated oil pump **ratio=5:1 28 l/min**
- Art.014-1048-000 Regulator with filter and air lubricator 1/4"
- Art.906-0424-020 1SC 1/2" hose F-F 2,0 m length
- Art.902-0202-020 R6 5/16" hose 1/4 M-F 2,0 m length
- Art.F96-0100-404 Nipple 1/2" M-1/2" M
- Art.025-1267-000 Tank-fixing bracket

**Art. 022-1890-000**

**Oil kit for IBC tanks 1000 l**

Composed like Art.022-1888-000 but with:

- Art.020-1196-000 Air-operated oil pump **ratio=3:1 30 l/min**

The tank is not included in the oil kit



<b>022-1888-000</b>	22,200	0,042	2
<b>022-1890-000</b>	22,000	0,042	2

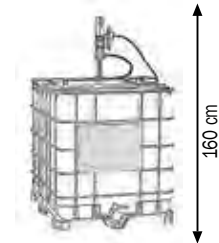

**Art. 022-1892-000**

**HIGH DELIVERY oil kit for IBC tanks 1000 l**

Composed by:

- Art.020-1183-000 Air-operated oil pump **ratio=5:1 35 l/min**
- Art.014-1048-B00 Regulator with filter and air lubricator 1/2"
- Art.906-0525-020 1SC 3/4" hose F-F 2,0 m length
- Art.902-0424-020 R6 1/2" hose F-F 2,0 m length
- Art.F96-0100-404 Nipple 1/2 M - 1/2 M
- Art.F96-0100-505 Nipple 3/4" M-3/4" M
- Art.025-1267-000 Tank-fixing bracket



**022-1892-000**

**Art. 022-1894-000**

**HIGH DELIVERY oil kit for IBC tanks 1000 l**

Composed like Art.022-1892-000 but with:

- Art.020-1179-000 Air-operated oil pump **ratio=3:1 40 l/min**

The tank is not included in the oil kit



<b>022-1892-000</b>	26,700	0,051	2
<b>022-1894-000</b>	27,300	0,051	2

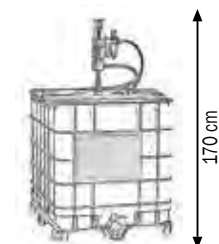

It is a modular solution that allows the oil delivery with connection to a centralized system, to a hose reel or directly to the delivery hose.

## Art. 022-1895-000

### Oil kit for IBC tanks 1000 l

Composed by:

- Art.020-1206-000 Air-operated oil pump **ratio=5:1 28 l/min**
- Art.014-1048-000 Regulator with filter and air lubricator 1/4"
- Art.906-0434-008 1SC 1/2" hose F-F 0,8 m length
- Art.902-0202-020 R6 5/16" hose 1/4" M-F 2,0 m length
- Art.070-1206-410 Fixed hose reel 1/2" 10,0 m length
- Art.024-1233-C00 Oil digital nozzle
- Art.024-1785-000 Support for drops collection
- Art.025-1267-000 Tank-fixing bracket
- Art.025-1267-B00 Fixing bracket for drops collection



**022-1895-000**

The tank is not included in the oil kit

## Art. 022-1896-000

### Oil kit for IBC tanks 1000 l

Composed like Art.022-1895-000 but with:

- Art.020-1196-000 Air-operated oil pump **ratio=3:1 30 l/min**



<b>022-1895-000</b>	46,700	0,120	4
<b>022-1896-000</b>	46,500	0,120	4

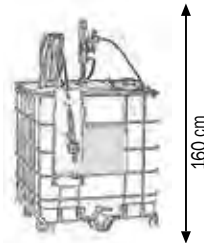

## Art. 022-1898-000

### HIGH DELIVERY oil kit for IBC tanks 1000 l

Composed by:

- Art.020-1183-000 Air-operated oil pump **ratio=5:1 35 l/min**
- Art.014-1048-B00 Regulator with filter and air lubricator 1/2"
- Art.906-0424-015 1SC 1/2" hose F-F 1,5 m length
- Art.902-0424-020 R6 1/2" hose F-F 2,0 m length
- Art.F96-0100-404 Nipple 1/2 M - 1/2 M
- Art.074-4506-410 Fixed closed hose reel 1/2" 10,0 m length
- Art.024-1233-C00 Oil digital nozzle
- Art.024-1785-000 Support for drops collection
- Art.025-1267-000 Tank-fixing bracket
- Art.025-1267-B00 Fixing bracket for drops collection



**022-1898-000**

The tank is not included in the oil kit

## Art. 022-1899-000

### HIGH DELIVERY oil kit for IBC tanks 1000 l

Composed like Art.022-1898-000 but with:

- Art.020-1179-000 Air-operated oil pump **ratio=3:1 40 l/min**



<b>022-1898-000</b>	59,600	0,130	4
<b>022-1899-000</b>	60,200	0,130	4

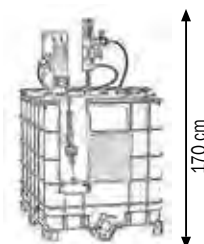

It is a complete solution that constitutes an independent working station. The pump, the hose reel and the support for drops collection are fixed directly to the tank by the supporting bracket.



**022-1900-000**

The tank is not included in the oil kit

**Art. 022-1900-000**

**Oil kit for IBC tank 1000 l with frontal pump**

Composed by:

- Art.020-1198-000 Air-operated oil pump **ratio=5:1 28 l/min**
- Art.014-1048-000 Regulator with filter and air lubricator 1/4"
- Art.025-5810-000 Frontal bracket for IBC tank
- Art.025-1265-000 Wall-fixing bracket
- Art.025-1267-000 Tank-fixing bracket
- Art.070-1206-410 Fixed hose reel 1/2" 10,0 m length
- Art.099-6010-000 Connections for IBC S60X6
- Art.902-0202-020 R6 5/16" hose 1/4" M-F 2,0 m length
- Art.906-0424-015 1SC 1/2" hose F-F 1,5 m length
- Art.911-0500-005 Suction PVC spiral hose Ø 20 mm 0,5 m l
- Art.B27-1120-032 N. 2 stainless steel screw clamps 20-32 mm
- Art.024-1233-C00 Oil digital dispensing nozzle
- Art.F24-9106-001 Removable basin for drops collection

**Art. 022-1903-000**

**Oil kit for IBC tank 1000 l with frontal pump**

Composed like Art.022-1900-000 but with:

- Art.020-1188-000 Air-operated oil pump **ratio=3:1 30 l/min**



<b>022-1900-000</b>	49,100	0,130	4
<b>022-1903-000</b>	48,900	0,130	4

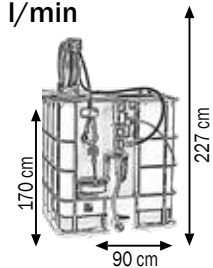

**Art. 022-1915-000**

**Oil kit for IBC tank 1000 l with frontal pump**

Composed by:

- Art.020-1198-000 Air-operated oil pump **ratio=5:1 28 l/min**
- Art.014-1048-000 Regulator with filter and air lubricator 1/4"
- Art.025-5810-000 Frontal bracket for IBC tank
- Art.025-1265-000 Wall-fixing bracket
- Art.099-6010-000 Connections for IBC S60X6
- Art.902-0202-020 R6 5/16" hose 1/4" M-F 2,0 m length
- Art.906-0404-030 1SC 1/2" hose M-F 3,0 m length
- Art.911-0500-005 Suction PVC spiral hose Ø 20 mm 0,5 m l
- Art.B27-1120-032 N. 2 stainless steel screw clamps 20-32 mm
- Art.024-1233-C00 Oil digital dispensing nozzle
- Art.F24-9106-001 Removable basin for drops collection



**022-1913-000**

The tank is not included in the oil kit

**Art. 022-1913-000**

**Oil kit for IBC tank 1000 l with frontal pump**

Composed like Art.022-1915-000 but with:

- Art.020-1188-000 Air-operated oil pump **ratio=3:1 30 l/min**



<b>022-1915-000</b>	22,200	0,070	2
<b>022-1913-000</b>	22,000	0,070	2

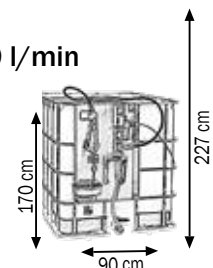

Example of installation with flexible hose

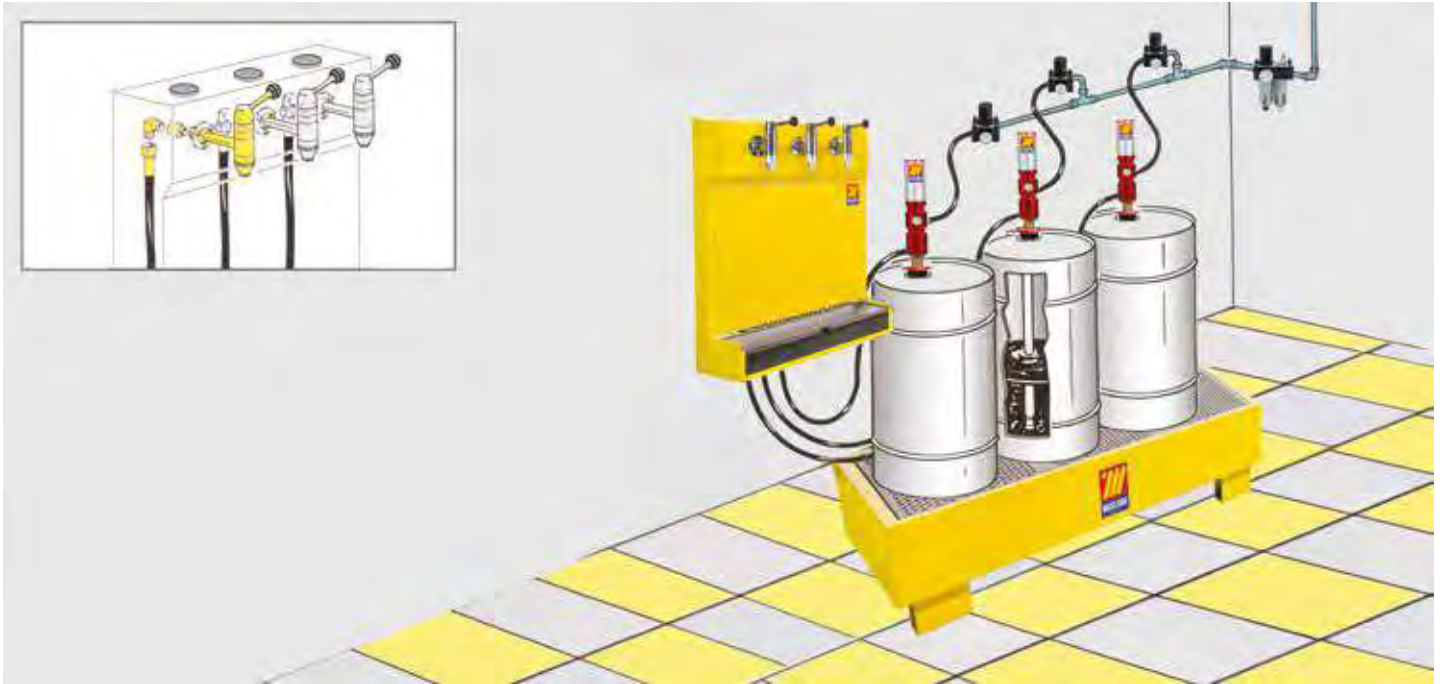

Example of installation with fixed system

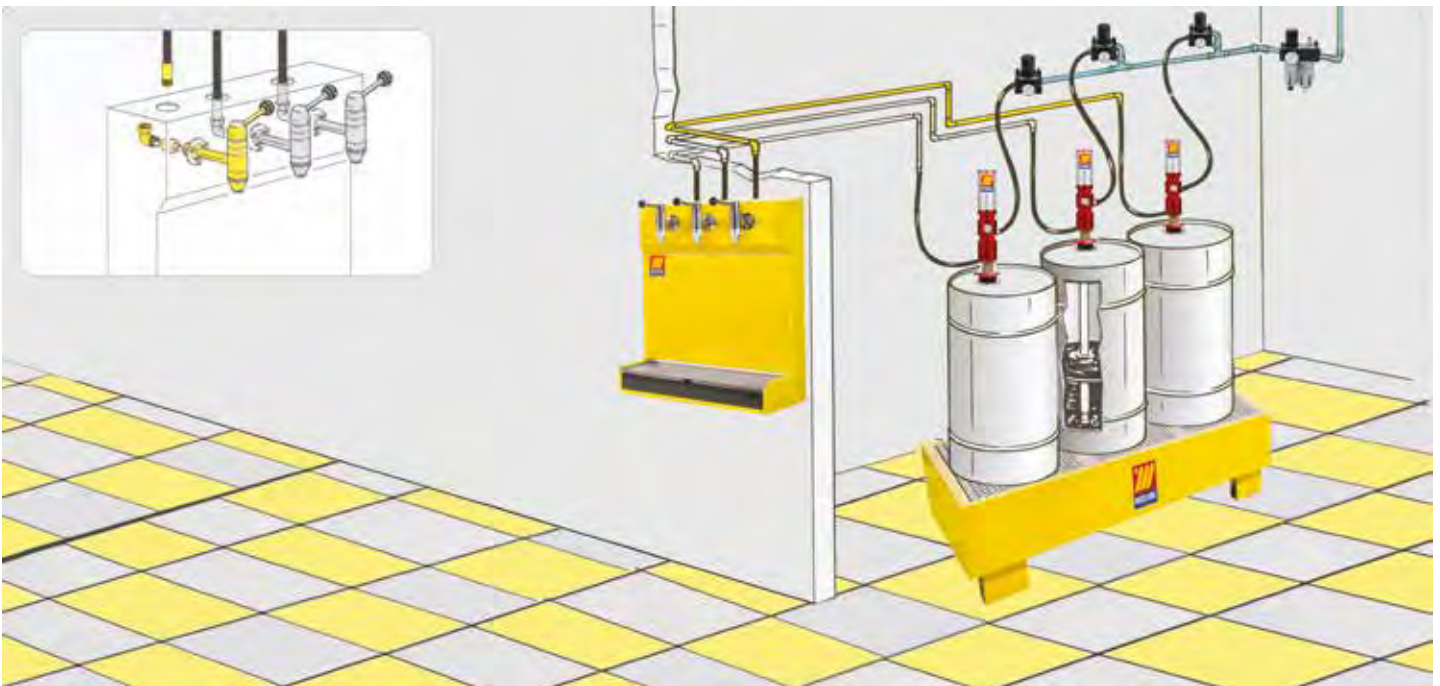

It is an alternative solution for those situations in which there are no hose-reels. It assures a quick and clean delivery, and without waste of lubricating oils for the different needs.

Connected to an air-operated pump (one for eachcock) and using the cock lever the dispenser is always ready. It is always supplied with an operating cock, it is pre-designed for other two cocks and it allows the simultaneous delivery of three different types of fluid.



**027-1340-000**

**Art. 027-1340-000**

Oil bar dispenser with 1 cock

Composed by:

N. 1 Cock with lever (Art.027-1348-000)

Removable basin for drops collection

Supporting grate



**027-1340-000** 23,900 0,086 1

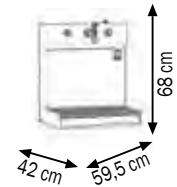

**027-1340-B00**

**Art. 027-1340-B00**

Oil bar dispenser with 2 cocks

Composed by:

N. 2 Cocks with lever (Art.027-1348-000)

Removable basin for drops collection

Supporting grate



**027-1340-B00** 25,600 0,086 1

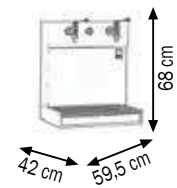

**027-1340-C00**

**Art. 027-1340-C00**

Oil bar dispenser with 3 cocks

Composed by:

N. 3 Cocks with lever (Art.027-1348-000)

Removable basin for drops collection

Supporting grate



**027-1340-C00** 27,100 0,086 1

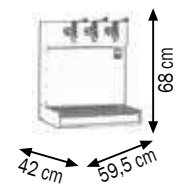

**027-1344-000**

**Art. 027-1344-000**

Oil bar dispenser with cabinet

Composed by:

Art.027-1340-000 Bar dispenser with 1 Cock and lever

Art.027-1352-000 Cabinet 1 door with lock,

inside drawer and two shelves



**027-1344-000** 53,900 0,314 1

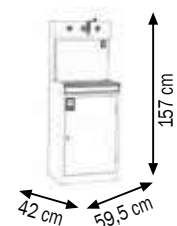

## Art. 027-1342-000

Oil bar dispenser with 1 cock and digital flow meter

Composed by:

N.1 Digital flow meter (Art.027-1351-000)

N.1 Cock with lever (Art.027-1348-000)

Removable basin for drops collection

Supporting grate



027-1342-000 24,400 0,086 1

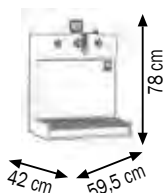

027-1342-000

## Art. 027-1342-B00

Oil bar dispenser with 2 cocks and digital flow meters

Composed by:

N. 2 Digital flow meters (Art.027-1351-000)

N. 2 Cocks with lever (Art.027-1348-000)

Removable basin for drops collection

Supporting grate



027-1342-B00 26,500 0,086 1

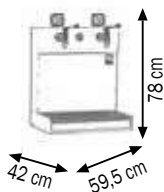

027-1342-B00

## Art. 027-1342-C00

Oil bar dispenser with 3 cocks and digital flow meters

Composed by:

N. 3 Digital flow meters (Art.027-1351-000)

N. 3 Cocks with lever (Art.027-1348-000)

Removable basin for drops collection

Supporting grate



027-1342-C00 28,600 0,086 1

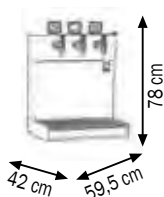

027-1342-C00

## Art. 027-1346-000

Oil bar dispenser with cabinet and digital flow meter

Composed by:

Art.027-1342-000 Bar dispenser with 1 Cock and lever

Art.027-1352-000 Cabinet 1 door with lock,

inside drawer and two shelves



027-1346-000 54,400 0,314 2

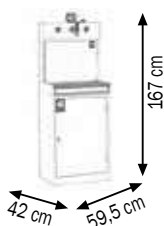

027-1346-000



**027-1347-000**

**Art. 027-1347-000**

Oil kit for drums of 180-220 l with cock lever

Composed by:

Art.020-1195-000 Air-operated oil pump ratio=3:1 bar

Art.027-1349-000 Cock with lever

Art.027-1350-000 Support for decanter

For the distribution of low and high viscosity oil

They are suitable for the application directly on the oil tank



**027-1348-000**

**Art. 027-1348-000**

Cock with lever for bar dispenser

A little pressure is enough to make the oil flow without sprays

**Art. 027-1348-A00**

Cock with lever for dispenser bar

For the delivery of anti-freeze liquid



**027-1349-000**

**Art. 027-1349-000**

Cock with lever for application on oil pump

With elbow connection



**027-1350-000**

**Art. 027-1350-000**

Support for decanter



**027-1351-000**

**Art. 027-1351-000**

Digital flow meter kit for bar dispenser

Composed by:

Digital flow meter (Art.024-1234-000)

1/2" connection



**027-1351-K00**

**Art. 027-1351-K00**

Connection hose kit for bar dispenser

Composed by:

1SC 1/2" m-f hose 3,0 m length

1/2" F-F L connection

1/2" nipple





Meclube brand-new **patented** industrial pumps, fully designed and manufactured by Meclube, have remarkable practical features assuring high performances, both for what concerns the quantity and the use at high pressure.

The technical quality, the choice of materials and the treatments of tempering and grinding result in the reduction of wear and make these pumps suitable to work reliably in the worst environmental conditions.

- **Brand new fully air-operated motion reverse device, without cams and springs. It has been internally improved to reduce to the minimum the reversal time and to improve the supply of the fluid.**
- **Reduced number of wearing parts**
- **The double effect shank grants a higher quantity of delivered oil with constant and continuous flow**
- **High pressure during the functioning, with constant power on all the motion path**
- **The body of the pump is in steel fusion with high silicon level, with electrolytic nickel treatment and chromium plating that ensures high resistance to corrosive agents.**
- **Elements that undergo big stress are in steel 18 NiCrMo 6 and afterwards they are treated and rebored to grant the robustness and minimum frictions.**
- **The pump has a modular structure of high robustness, suitable for heavy duty usages.**



### **AIR-OPERATED INDUSTRIAL FLANGED PUMPS**

Air-operated engine body and shank group kit up a unique body.

On the basis of the engine will be applied a bracket with handles that help the movement and the fixing in other applications.

### **AIR-OPERATED INDUSTRIAL DISJOINT PUMPS**

Air-operated engine body and shank group are separate, in this way the fluid doesn't go in contact directly with the engine body.

They are suitable for the transfer of oil and industrial and chemical fluids with aggressive characteristics.

They grant high performance as delivery (l/min) and also as pressure in the using of application.

### Art. 021-0905-000

Air-operated industrial oil pump Mod. 905 flanged  
 Ratio=5:1 double-acting Delivery capacity 50 l/min  
 For wall-fixing or fixed positions.  
 Polyurethane seals



021-0905-000

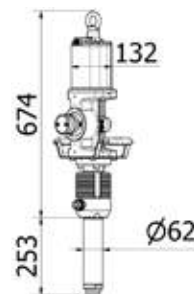

021-0905-000 24,400 0,110 1

Technical Data		021-0905-000
Compression ratio		5:1
Working pressure	bar	8
Air consumption at 8 bar	m <sup>3</sup> /min	1,75
Air inlet connection	BSP	F 1/2" G
Fluid outlet connection	BSP	M 3/4" G
Fluid delivery cap. at 8 bar	l/min	50
Noise	dB	80
Shank diameter	mm	62
Shank length	mm	Modular F1"

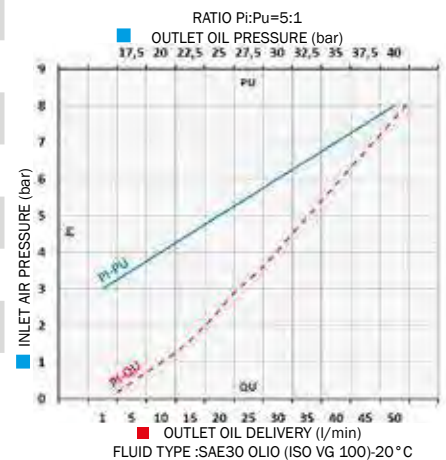

These pumps are advised for the transfer of low-high viscosity oil and similar fluids for medium-long distances. The delivery capacity of a pump varies according to particular applications and combinations. The operating pressure may vary between a minimum of 3 bar and a maximum of 8 bar. The double-acting guarantees the delivery of a continuous and constant flow, suitable for installations on distribution facilities. To optimize the performance and the time-life of the air-operated pumps we advise to use filtered and lubricated air.



### Art. 021-0908-000

Air-operated industrial oil pump Mod. 908 flanged  
Ratio=8:1 double-acting Delivery capacity 40 l/min  
For wall-fixing or fixed positions.  
Polyurethane seals

### Art. 021-0908-094

Air-operated industrial oil pump Mod. 908 flanged  
Ratio=8:1 double-acting Delivery capacity 40 l/min  
For drums of 180-220 l  
Polyurethane seals

### Art. 021-0908-125

Air-operated industrial oil pump Mod. 908 flanged  
Ratio=8:1 double-acting Delivery capacity 40 l/min  
For tanks of 750-1500 l  
Polyurethane seals

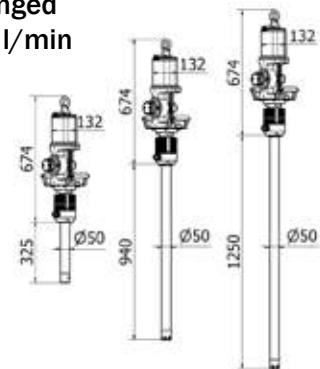

021-0908-000	23,000	0,110	1
021-0908-094	25,900	0,150	1
021-0908-125	27,600	0,180	1

Technical Data	021-0908-000	021-0908-094	021-0908-125
Compression ratio	8:1	8:1	8:1
Working pressure	bar	8	8
Air consumption at 8 bar	m <sup>3</sup> /min	1,75	1,75
Air inlet connection	BSP	F 1/2" G	F 1/2" G
Fluid outlet connection	BSP	M 3/4" G	M 3/4" G
Fluid delivery cap. at 8 bar	l/min	40	40
Noise	dB	80	80
Shank diameter	mm	50	50
Shank length	mm	Modular F 1"	940
For drums	l	-	180-220
			750-1500

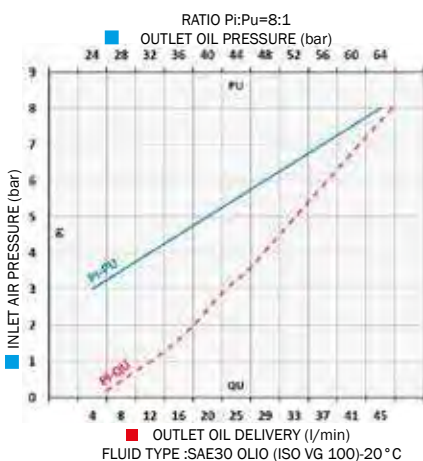

These pumps are advised for the transfer of low-high viscosity oil and similar fluids for medium-long distances. The delivery capacity of a pump varies according to particular applications and combinations. The operating pressure may vary between a minimum of 3 bar and a maximum of 8 bar.

The double-acting guarantees the delivery of a continuous and constant flow, suitable for installations on distribution facilities. To optimize the performance and the time-life of the air-operated pumps we advise to use filtered and lubricated air.

# AIR-OPERATED INDUSTRIAL PUMPS FOR OIL AND SIMILAR FLUIDS

## Mod. 910 FLANGED

COMPRESSION RATIO = 10:1 DELIVERY CAPACITY = 35 l/min



### Art. 021-0910-000

Air-operated industrial oil pump Mod. 910 flanged  
Ratio=10:1 double-acting Delivery capacity 35 l/min  
For wall-fixing or fixed positions.  
Polyurethane seals

### Art. 021-0910-094

Air-operated industrial oil pump Mod. 910 flanged  
Ratio=10:1 double-acting Delivery capacity 35 l/min  
For drums of 180-220 l  
Polyurethane seals

### Art. 021-0910-125

Air-operated industrial oil pump Mod. 910 flanged  
Ratio=10:1 double-acting Delivery capacity 35 l/min  
For tanks of 750-1500 l  
Polyurethane seals

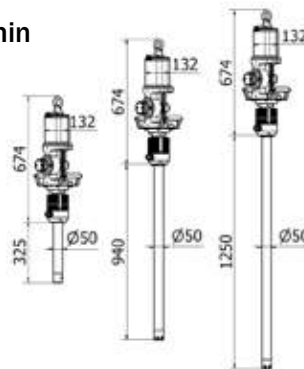

021-0910-000	23,700	0,110	1
021-0910-094	28,200	0,150	1
021-0910-125	31,100	0,180	1

Technical Data		021-0910-000	021-0910-094	021-0910-125
Compression ratio		10:1	10:1	10:1
Working pressure	bar	8	8	8
Air consumption at 8 bar	m³/min	1,75	1,75	1,75
Air inlet connection	BSP	F 1/2" G	F 1/2" G	F 1/2" G
Fluid outlet connection	BSP	M 3/4" G	M 3/4" G	M 3/4" G
Fluid delivery cap. at 8bar	l/min	35	35	35
Noise	dB	80	80	80
Shank diameter	mm	50	50	50
Shank length	mm	Modular F 1"	940	1250
For drums	l	-	180-220	750-1500

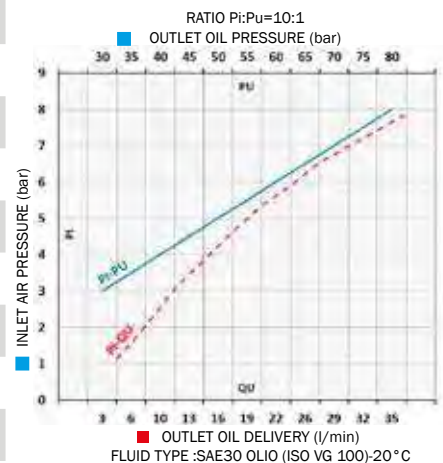

These pumps are advised for the transfer of low-high viscosity oil and similar fluids for medium-long distances. The delivery capacity of a pump varies according to particular applications and combinations. The operating pressure may vary between a minimum of 3 bar and a maximum of 8 bar. The double-acting guarantees the delivery of a continuous and constant flow, suitable for installations on distribution facilities. To optimize the performance and the time-life of the air-operated pumps we advise to use filtered and lubricated air.



021-1210-000

### Art. 021-1210-000

Air-operated industrial oil pump Mod. 1210 flanged  
Ratio=10:1 double-acting Delivery capacity 45 l/min  
For wall-fixing or fixed positions.  
Polyurethane seals

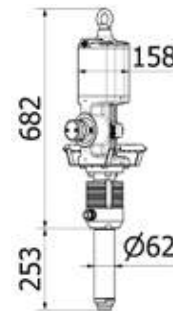

021-1210-000 25,500 0,110 1

### Technical Data

021-1210-000

Compression ratio		10:1
Working pressure	bar	8
Air consumption at 8 bar	m <sup>3</sup> /min	2,90
Air inlet connection	BSP	F 1/2" G
Fluid outlet connection	BSP	M 3/4" G
Fluid delivery cap. at 8 bar	l/min	45
Noise	dB	80
Shank diameter	mm	62
Shank length	mm	Modular F 1"

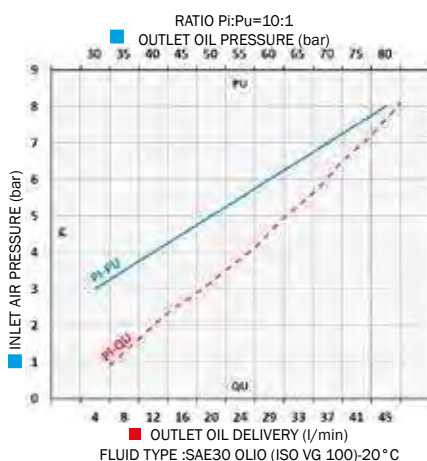

These pumps are advised for the transfer of low-high viscosity oil and similar fluids for medium-long distances. The delivery capacity of a pump varies according to particular applications and combinations. The operating pressure may vary between a minimum of 3 bar and a maximum of 8 bar.

The double-acting guarantees the delivery of a continuous and constant flow, suitable for installations on distribution facilities. To optimize the performance and the time-life of the air-operated pumps we advise to use filtered and lubricated air.

# AIR-OPERATED INDUSTRIAL PUMPS FOR OIL AND SIMILAR FLUIDS

## Mod. 1214 FLANGED

COMPRESSION RATIO = 14:1 DELIVERY CAPACITY = 30 l/min



### Art. 021-1214-000

Air-operated industrial oil pump Mod. 1214 flanged  
Ratio=14:1 double-acting Delivery capacity 30 l/min  
For wall-fixing or fixed positions.  
Polyurethane seals

### Art. 021-1214-094

Air-operated industrial oil pump Mod. 1214 flanged  
Ratio=14:1 double-acting Delivery capacity 30 l/min  
For drums of 180-220 l  
Polyurethane seals

### Art. 021-1214-125

Air-operated industrial oil pump Mod. 1214 flanged  
Ratio=14:1 double-acting Delivery capacity 30 l/min  
For tanks of 750-1500 l  
Polyurethane seals

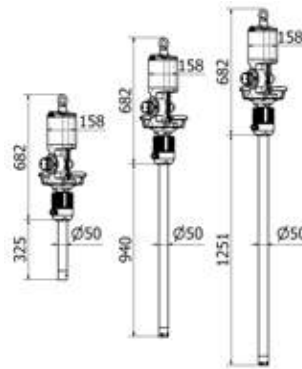

021-1214-000	24,100	0,110	1
021-1214-094	27,000	0,150	1
021-1214-125	29,200	0,180	1

Technical Data		021-1214-000	021-1214-094	021-1214-125
Compression ratio		14:1	14:1	14:1
Working pressure	bar	8	8	8
Air consumption at 8 bar	m <sup>3</sup> /min	2,90	2,90	2,90
Air inlet connection	BSP	F 1/2" G	F 1/2" G	F 1/2" G
Fluid outlet connection	BSP	M 3/4" G	M 3/4" G	M 3/4" G
Fluid delivery cap. at 8 bar	l/min	30	30	30
Noise	dB	80	80	80
Shank diameter	mm	50	50	50
Shank length	mm	Modular F 1"	940	1250
For drums	l	-	180-220	750-1500

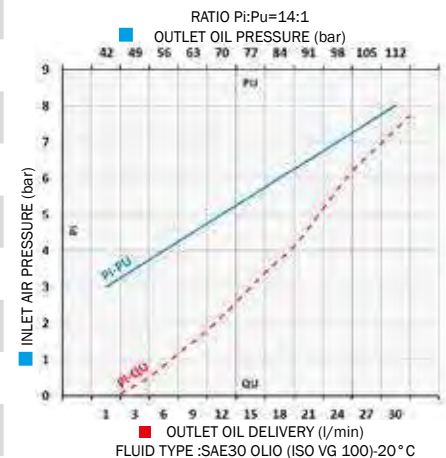

These pumps are advised for the transfer of low-high viscosity oil and similar fluids for medium-long distances. The delivery capacity of a pump varies according to particular applications and combinations. The operating pressure may vary between a minimum of 3 bar and a maximum of 8 bar. The double-acting guarantees the delivery of a continuous and constant flow, suitable for installations on distribution facilities. To optimize the performance and the time-life of the air-operated pumps we advise to use filtered and lubricated air.

### Art. 021-1218-000

Air-operated industrial oil pump Mod. 1218 flanged  
Ratio=18:1 double-acting Delivery capacity 25 l/min  
For wall-fixing or fixed positions.  
Polyurethane seals

### Art. 021-1218-094

Air-operated industrial oil pump Mod. 1218 flanged  
Ratio=18:1 double-acting Delivery capacity 25 l/min  
For drums of 180-220 l  
Polyurethane seals

### Art. 021-1218-125

Air-operated industrial oil pump Mod. 1218 flanged  
Ratio=18:1 double-acting Delivery capacity 25 l/min  
For tanks of 750-1500 l  
Polyurethane seals

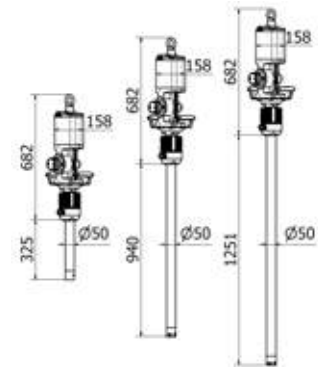

Art.	Weight (Kg)	Volume (m <sup>3</sup> )	Boxes
021-1218-000	24,800	0,110	1
021-1218-094	29,200	0,150	1
021-1218-125	32,200	0,180	1

Technical Data	021-1218-000	021-1218-094	021-1218-125
Compression ratio	18:1	18:1	18:1
Working pressure	bar	8	8
Air consumption at 8 bar	m <sup>3</sup> /min	2,90	2,90
Air inlet connection	BSP	F 1/2" G	F 1/2" G
Fluid outlet connection	BSP	M 3/4" G	M 3/4" G
Fluid delivery cap. at 8 bar	l/min	25	25
Noise	dB	80	80
Shank diameter	mm	50	50
Shank length	mm	Modular F 1"	940
For drums	l	-	180-220
			750-1500

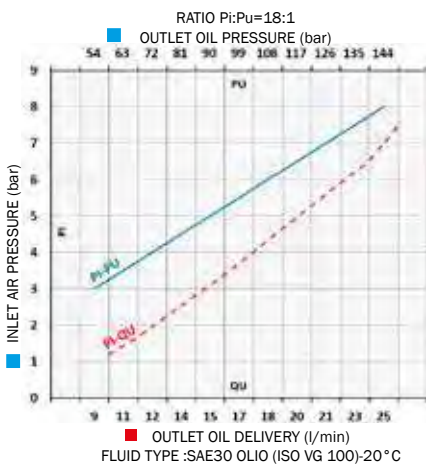

These pumps are advised for the transfer of low-high viscosity oil and similar fluids for medium-long distances. The delivery capacity of a pump varies according to particular applications and combinations. The operating pressure may vary between a minimum of 3 bar and a maximum of 8 bar.

The double-acting guarantees the delivery of a continuous and constant flow, suitable for installations on distribution facilities. To optimize the performance and the time-life of the air-operated pumps we advise to use filtered and lubricated air.

# AIR-OPERATED INDUSTRIAL PUMPS FOR OIL AND SIMILAR FLUIDS

## Mod. 1520 FLANGED

COMPRESSION RATIO = 20:1

DELIVERY CAPACITY = 40 l/min



### Art. 021-1520-000

Air-operated industrial oil pump Mod. 1520 flanged  
 Ratio=20:1 double-acting Delivery capacity 40 l/min  
 For wall-fixing or fixed positions.  
 Polyurethane seals

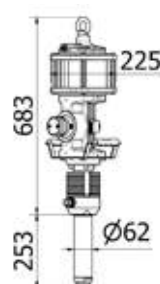

021-1520-000 27,900 0,110 1

### Technical Data 021-1520-000

Compression ratio		20:1
Working pressure	bar	8
Air consumption at 8 bar	m <sup>3</sup> /min	3,5
Air inlet connection	BSP	F 1/2" G
Fluid outlet connection	BSP	M 3/4" G
Fluid delivery cap. at 8 bar	l/min	40
Noise	dB	80
Shank diameter	mm	62
Shank length	mm	Modular F1"

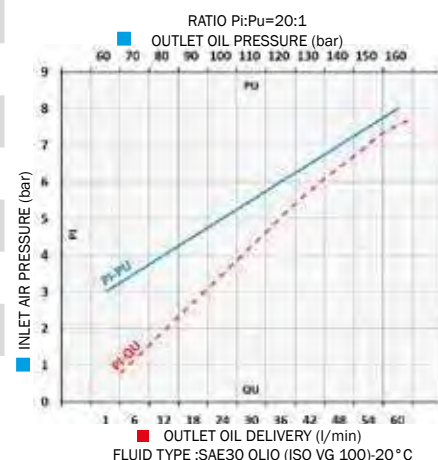

These pumps are advised for the transfer of low-high viscosity oil and similar fluids for medium-long distances. The delivery capacity of a pump varies according to particular applications and combinations. The operating pressure may vary between a minimum of 3 bar and a maximum of 8 bar. The double-acting guarantees the delivery of a continuous and constant flow, suitable for installations on distribution facilities. To optimize the performance and the time-life of the air-operated pumps we advise to use filtered and lubricated air.



# AIR-OPERATED INDUSTRIAL DISJOINT PUMPS FOR OIL AND CHEMICAL PRODUCTS



MECLUBE  
MADE IN ITALY

# AIR-OPERATED INDUSTRIAL DISJOINT PUMPS FOR OIL AND CHEMICAL PRODUCTS



## Art. 021-0905-DT0

Air-operated industrial disjoint pump for oil and chemical products  
Mod. 905D

Ratio=5:1 double-acting Delivery capacity 50 l/min

For wall-fixing or fixed positions.

Teflon seals

## Art. 021-0908-DT0

Air-operated industrial disjoint pump for oil and chemical products  
Mod. 908D

Ratio=8:1 double-acting Delivery capacity 40 l/min

For wall-fixing or fixed positions.

Teflon seals

## Art. 021-0910-DT0

Air-operated industrial disjoint pump for oil and chemical products  
Mod. 910D

Ratio=10:1 double-acting Delivery capacity 35 l/min

For wall-fixing or fixed positions.

Teflon seals



021-0905-DT0	24,100	0,110	1
021-0908-DT0	23,000	0,110	1
021-0910-DT0	23,700	0,110	1

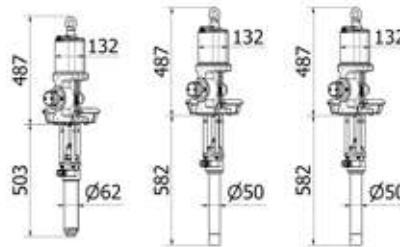

Technical Data		021-0905-DT0	021-0908-DT0	021-0910-DT0
Compression ratio		5:1	8:1	10:1
Working pressure	bar	8	8	8
Air consumption at 8 bar	m <sup>3</sup> /min	1,75	1,75	1,75
Air inlet connection	BSP	F 1/2" G	F 1/2" G	F 1/2" G
Fluid outlet connection	BSP	M 3/4" G	M 3/4" G	M 3/4" G
Fluid delivery cap. at 8 bar	l/min	50	40	35
Noise	dB	80	80	80
Shank diameter	mm	62	50	50
Shank length	mm	Modular F 1"	Modular F 1"	Modular F 1"

Automatic engine body and shank kit are divided in order to avoid that the fluid enters directly in contact with motor body. These pumps are advised for the transfer of oil and industrial fluids for medium-long distances, guarantee high performance as per delivery capacity (l/min) and also for working pressure. The delivery capacity of a pump varies according to particular applications and combinations.

The operating pressure may vary between a minimum of 3 bar and a maximum of 8 bar. The double-acting guarantees the delivery of a continuous and constant flow, suitable for installations on distribution facilities. To optimize the performance and the time-life of the air-operated pumps we advise to use filtered and lubricated air.

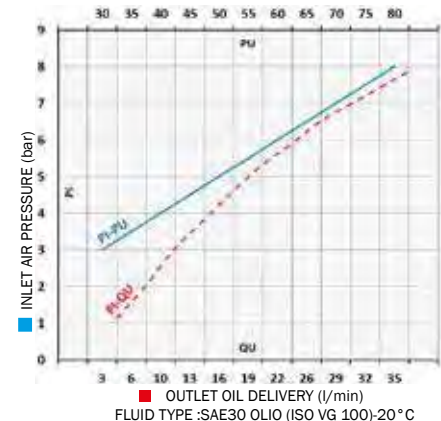
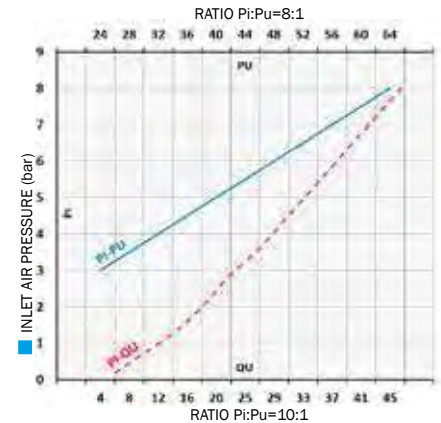
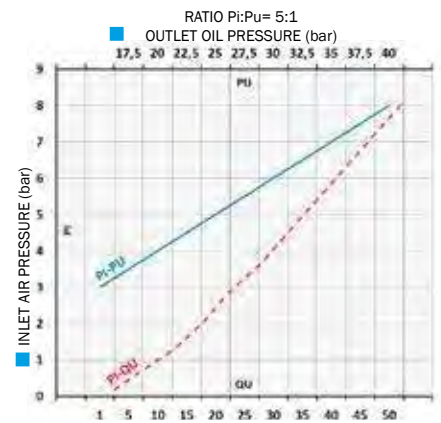

FLUID TYPE :SAE30 OLIO (ISO VG 100)-20°C



## Art. 021-1210-DT0

Air-operated industrial disjoint pump for oil and chemical products  
Mod. 1210D

Ratio=10:1 double-acting Delivery capacity 45 l/min

For wall-fixing or fixed positions.

Teflon seals

## Art. 021-1214-DT0

Air-operated industrial disjoint pump for oil and chemical products  
Mod. 1214D

Ratio=14:1 double-acting Delivery capacity 30 l/min

For wall-fixing or fixed positions.

Teflon seals

## Art. 021-1218-DT0

Air-operated industrial disjoint pump for oil and chemical products  
Mod. 1218D

Ratio=18:1 double-acting Delivery capacity 25 l/min

For wall-fixing or fixed positions.

Teflon seals

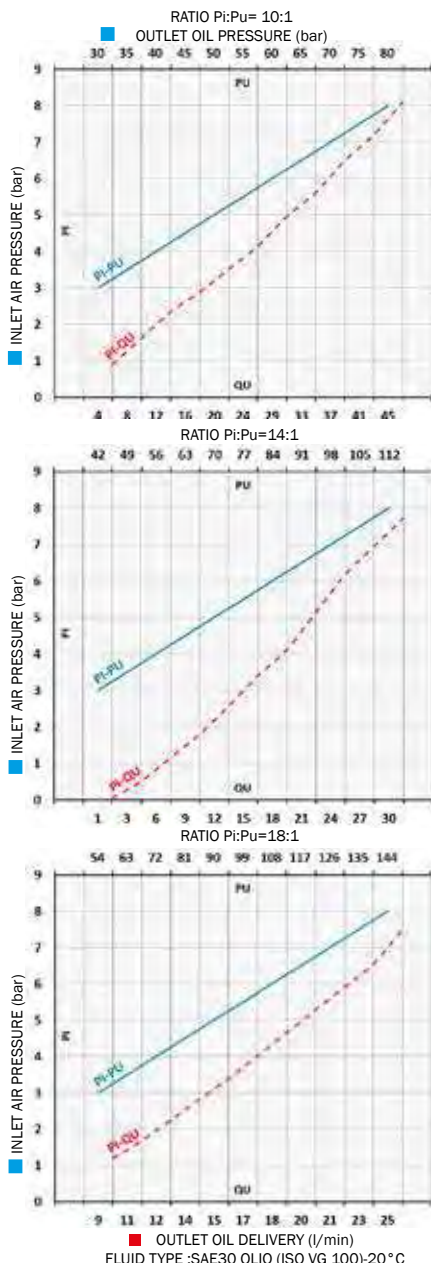

021-1210-DT0	25,100	0,110	1
021-1214-DT0	24,000	0,110	1
021-1218-DT0	24,700	0,110	1

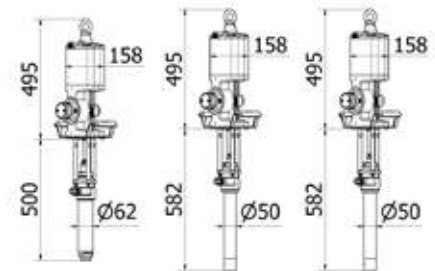

Technical Data	021-1210-DT0	021-1214-DT0	021-1218-DT0
Compression ratio	10:1	14:1	18:1
Working pressure	bar	8	8
Air consumption at 8 bar	m <sup>3</sup> /min	2,90	2,90
Air inlet connection	BSP	F 1/2" G	F 1/2" G
Fluid outlet connection	BSP	M 3/4" G	M 3/4" G
Fluid delivery cap. at 8 bar	l/min	45	30
Noise	dB	80	80
Shank diameter	mm	62	50
Shank length	mm	Modular F 1"	Modular F 1"

Automatic engine body and shank kit are divided in order to avoid that the fluid enters directly in contact with motor body. These pumps are advised for the transfer of oil and industrial fluids for medium-long distances, guarantee high performance as per delivery capacity (l/min) and also for working pressure. The delivery capacity of a pump varies according to particular applications and combinations.

The operating pressure may vary between a minimum of 3 bar and a maximum of 8 bar. The double-acting guarantees the delivery of a continuous and constant flow, suitable for installations on distribution facilities. To optimize the performance and the time-life of the air-operated pumps we advise to use filtered and lubricated air.

# AIR-OPERATED INDUSTRIAL DISJOINT PUMPS FOR OIL AND CHEMICAL PRODUCTS Mod.902D HIGH DELIVERY

COMPRESSION RATIO = 2:1 DELIVERY CAPACITY = 95 l/min



## Art. 021-0902-DPO

Air-operated industrial disjoint pump for oil, lubricants and similar fluids  
Mod. 902D HIGH DELIVERY

Ratio=2:1 double-acting Delivery capacity 95 l/min

For wall-fixing or fixed positions.

Polyurethane seals

## Art. 021-0902-DVO

Air-operated industrial disjoint pump for chemical fluids  
Mod. 902D HIGH DELIVERY

Ratio=2:1 double-acting Delivery capacity 95 l/min

For wall-fixing or fixed positions.

Viton seals

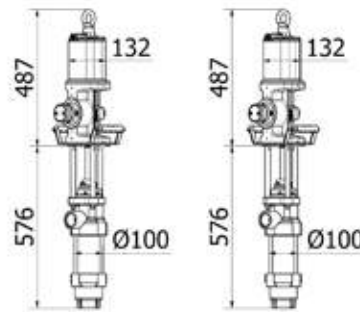

021-0902-DPO	38,200	0,110	1
021-0902-DVO	38,200	0,110	1

Technical Data		021-0902-DPO	021-0902-DVO
Compression ratio		2:1	2:1
Working pressure	bar	8	8
Air consumption at 8 bar	m <sup>3</sup> /min	1,75	1,75
Air inlet connection	BSP	F 1/2" G	F 1/2" G
Fluid outlet connection	BSP	F 1.1/2" G	F 1.1/2" G
Fluid delivery cap. at 8 bar	l/min	95	95
Noise	dB	80	80
Shank diameter	mm	100	100
Shank length	mm	Modular F 2"	Modular F 2"

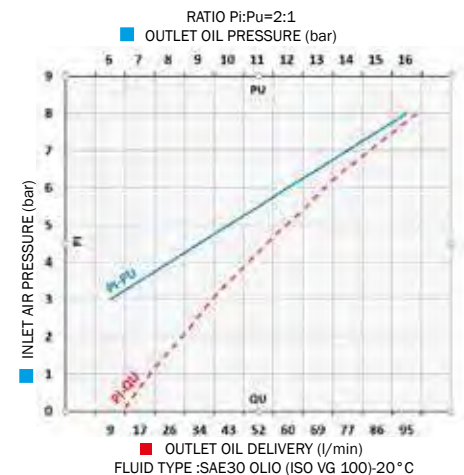

Automatic engine body and shank kit are divided in order to avoid that the fluid enters directly in contact with motor body. These pumps are advised for the transfer of oil and industrial fluids for medium-long distances, guarantee high performance as per delivery capacity (l/min) and also for working pressure.

The delivery capacity of a pump varies according to particular applications and combinations.

The operating pressure may vary between a minimum of 3 bar and a maximum of 8 bar. The double-acting guarantees the delivery of a continuous and constant flow, suitable for installations on distribution facilities. To optimize the performance and the time-life of the air-operated pumps we advise to use filtered and lubricated air.



### Art. 021-1203-DPO

Air-operated industrial disjoint pump for oil, lubricants and similar fluids  
Mod. 1203D HIGH DELIVERY

Ratio=3:1 double-acting Delivery capacity 100 l/min

For wall-fixing or fixed positions.

Polyurethane seals

### Art. 021-1203-DVO

Air-operated industrial disjoint pump for chemical fluids  
Mod. 1203D HIGH DELIVERY

ratio=3:1 double-acting Delivery capacity 100 l/min

For wall-fixing or fixed positions.

Viton seals

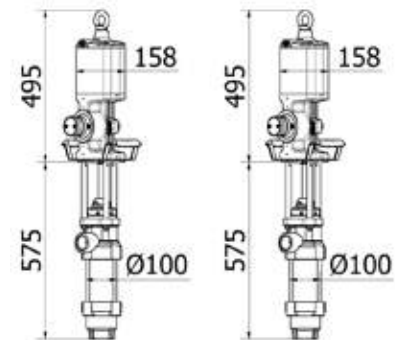

021-1203-DPO	39,200	0,110	1
021-1203-DVO	39,200	0,110	1

### Technical Data

		021-1203-DPO	021-1203-DVO
Compression ratio		3:1	3:1
Working pressure	bar	8	8
Air consumption at 8 bar	m <sup>3</sup> /min	2,90	2,90
Air inlet connection	BSP	F 1/2" G	F 1/2" G
Fluid outlet connection	BSP	F 1.1/2" G	F 1.1/2" G
Fluid delivery cap. at 8 bar	l/min	100	100
Noise	dB	80	80
Shank diameter	mm	100	100
Shank length	mm	Modular F 2"	Modular F 2"

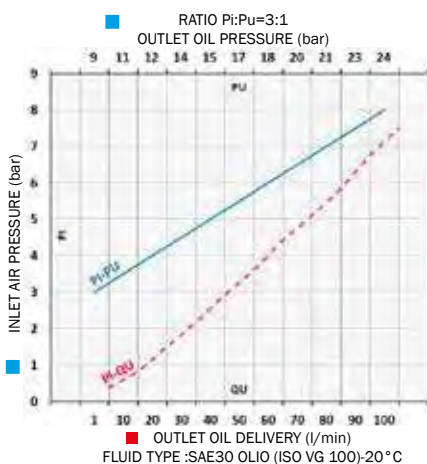

Automatic engine body and shank kit are divided in order to avoid that the fluid enters directly in contact with motor body. These pumps are advised for the transfer of oil and industrial fluids for medium-long distances, guarantee high performance as per delivery capacity (l/min) and also for working pressure.

The delivery capacity of a pump varies according to particular applications and combinations.

The operating pressure may vary between a minimum of 3 bar and a maximum of 8 bar. The double-acting guarantees the delivery of a continuous and constant flow, suitable for installations on distribution facilities. To optimize the performance and the time-life of the air-operated pumps we advise to use filtered and lubricated air.

# AIR-OPERATED INDUSTRIAL DISJOINT PUMPS FOR OIL AND CHEMICAL PRODUCTS Mod.1506D HIGH DELIVERY

COMPRESSION RATIO = 6:1 DELIVERY CAPACITY = 80 l/min



## Art. 021-1506-DPO

Air-operated industrial disjoint pump for oil, lubricants and similar fluids  
Mod. 1506D HIGH DELIVERY

Ratio=6:1 double-acting Delivery capacity 80 l/min

For wall-fixing or fixed positions.

Polyurethane seals

## Art. 021-1506-DVO

Air-operated industrial disjoint pump for chemical fluids  
Mod. 1506D HIGH DELIVERY

ratio=6:1 double-acting Delivery capacity 80 l/min

For wall-fixing or fixed positions.

Viton seals

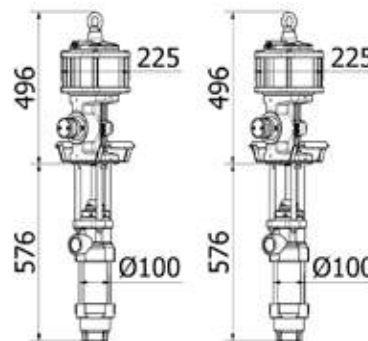

021-1506-DPO	41,800	0,110	1
021-1506-DVO	41,800	0,110	1

Technical Data		021-1506-DPO	021-1506-DVO
Compression ratio		6:1	6:1
Working pressure	bar	8	8
Air consumption at 8 bar	m <sup>3</sup> /min	3,50	3,50
Air inlet connection	BSP	F 1/2" G	F 1/2" G
Fluid outlet connection	BSP	F 1.1/2" G	F 1.1/2" G
Fluid delivery cap. at 8 bar	l/min	80	80
Noise	dB	80	80
Shank diameter	mm	100	100
Shank length	mm	Modular F 2"	Modular F 2"

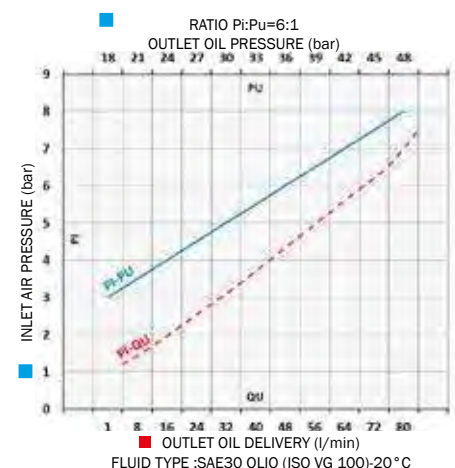

Automatic engine body and shank kit are divided in order to avoid that the fluid enters directly in contact with motor body. These pumps are advised for the transfer of oil and industrial fluids for medium-long distances, guarantee high performance as per delivery capacity (l/min) and also for working pressure.

The delivery capacity of a pump varies according to particular applications and combinations.

The operating pressure may vary between a minimum of 3 bar and a maximum of 8 bar. The double-acting guarantees the delivery of a continuous and constant flow, suitable for installations on distribution facilities. To optimize the performance and the time-life of the air-operated pumps we advise to use filtered and lubricated air.

# FRAME LIFTER-PRESS TO FIT PUMPS FOR LUBRICANTS AND SIMILAR FLUIDS



## Art. 012-1200-030

### Frame lifter and press

equipped with follower plate for pumps with shank  $\varnothing$  30 mm

## Art. 012-1200-042

### Frame lifter and press

equipped with follower plate for pumps with shank  $\varnothing$  42 mm

## Art. 012-1200-050

### Frame lifter and press

equipped with follower plate for pumps with shank  $\varnothing$  50 mm

## Art. 012-1200-200

### Frame lifter and press

equipped with follower plate for pumps with shank F 2"G

012-1200-045



Art.	kg	m <sup>3</sup>	Box
012-1200-030	228,000	1,920	1
012-1200-042	228,000	1,920	1
012-1200-050	228,000	1,920	1
012-1200-200	228,000	1,920	1

Maximum height	Minimum height	Maximum pressure	Pushing power	For drums	Viscosity
			4 bar - 450 kg		
2802 mm	1802 mm	8 bar	6 bar - 650 kg	180 - 220 kg	200 - 500
			8 bar - 870 kg		ASTM (25 °C)

## Air-operated two columns pumps lifter and press for lubricants and viscous fluids

With its particular 3 ways control valve it lifts or pulls down the pump and the follower plate, improving the exchanging effort of 180-220kg (400 lbs) drums.

It is particularly advised for the use with high viscosity lubricants and fluids (from 200CPS to 500CPS).

The follower plate is pushed down by the pressurised pneumatic cylinders, avoiding lubricant flow interruptions by air pockets.

Moreover, it allows to collect all the product from the inner walls down to the bottom of the drum, pump suction is assisted.

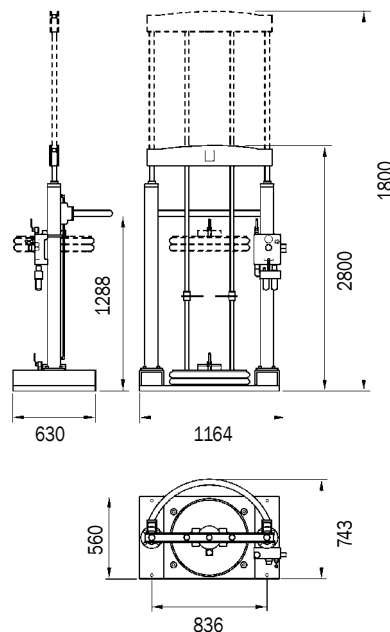
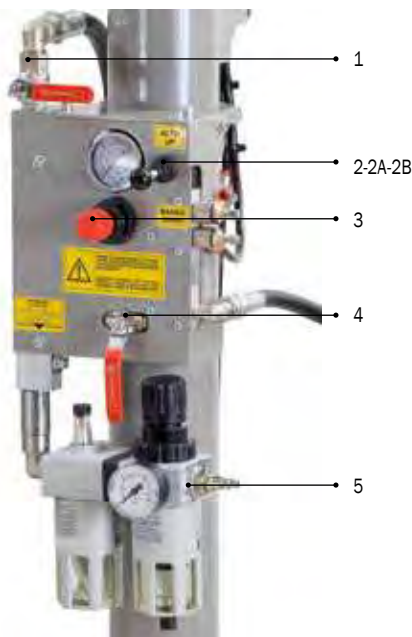

- Cock for pump air supply
- Off position
- 2A Up position to lift the pump and follower plate
- 2B Down position to activate the press-fluid
- Pressure regulator with manometer for air supply of the lifter
- Cock for air supply to lift the follower plate
- Inlet general air supply into filter and lubricator

**Art. 022-1403-000**

**Kit pump frame lifter and press for lubricants for drums 180-220 kg  
Delivery 100 l/min**

Composed by:

Art.012-1200-200 Pump frame lifter and press 2 columns + follower plate

Art.021-1203-DP0 Air-operated Industrial **disjoint** pump **ratio=3:1**

Art.902-0323-010 Rubber hose R6 3/8" F-F 3/8" 1 M length

Art.902-0424-010 Rubber hose R6 1/2" F-F 1/2" 1 M length



**022-1403-000**

**Art. 022-1408-000**

**Kit pump frame lifter and press for lubricants for drums 180-220 kg  
Delivery 40 l/min**

Composed by:

Art.012-1200-050 Pump frame lifter and press 2 columns + follower plate

Art.021-0908-094 Air-operated Industrial pump **ratio=8:1**

Art.902-0323-010 Rubber hose R6 3/8" F-F 3/8" 1 M length

Art.902-0424-010 Rubber hose R6 1/2" F-F 1/2" 1 M length

**Art. 022-1410-000**

**Kit pump frame lifter and press for lubricants for drums 180-220 kg  
Delivery 35 l/min**

Composed by:

Art.012-1200-050 Pump frame lifter and press 2 columns + follower plate

Art.021-0910-094 Air-operated Industrial pump **ratio=10:1**

Art.902-0323-010 Rubber hose R6 3/8" F-F 3/8" 1 M length

Art.902-0424-010 Rubber hose R6 1/2" F-F 1/2" 1 M length

**Art. 022-1414-000**

**Kit pump frame lifter and press for lubricants for drums 180-220 kg  
Delivery 30 l/min**

Composed by:

Art.012-1200-050 Pump frame lifter and press 2 columns + follower plate

Art.021-1214-094 Air-operated Industrial pump **ratio=14:1**

Art.902-0323-010 Rubber hose R6 3/8" F-F 3/8" 1 M length

Art.902-0424-010 Rubber hose R6 1/2" F-F 1/2" 1 M length



**022-1414-000**

**Art. 022-1418-000**

**Kit pump frame lifter and press for lubricants for drums 180-220 kg  
Delivery 25 l/min**

Composed by:

Art.012-1200-050 Pump frame lifter and press 2 columns + follower plate

Art.021-1218-094 Air-operated Industrial pump **ratio=18:1**

Art.902-0323-010 Rubber hose R6 3/8" F-F 3/8" 1 M length

Art.902-0424-010 Rubber hose R6 1/2" F-F 1/2" 1 M length



<b>022-1403-000</b>	263,900	1,920	2
<b>022-1408-000</b>	250,000	1,920	2
<b>022-1410-000</b>	252,300	1,920	2
<b>022-1414-000</b>	251,100	1,920	2
<b>022-1418-000</b>	253,400	1,920	2



**022-3100-000**

## Art. 022-3100-000

Industrial pump oil kit for drums 180-220 l

Composed by:

Art.021-0908-094 Oil industrial pump **R=8:1 40 l/min**

Art.025-1264-000 Ø 50 mm threaded ring

Art.906-0505-030 1SC 3/4" Hose M-F 3,0 m lenght

Art.024-1245-G00 High delivery oil **digital** dispensing nozzle



**022-3100-000** 31,000 0,137 2

Ø 550-600 mm

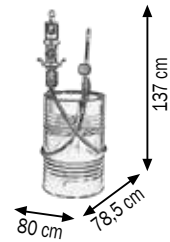

**022-3110-000**

## Art. 022-3110-000

Industrial pump oil kit for drums 180-220 l

Composed by:

Art.021-0908-094 Oil industrial pump **R=8:1 40 l/min**

Art.025-1264-000 Ø 50 mm threaded ring

Art.030-1405-000 4 wheels trolley

Art.906-0505-030 1SC 3/4" Hose M-F 3,0 m lenght

Art.024-1245-G00 High delivery oil **digital** dispensing nozzle



**022-3110-000** 77,000 0,280 2

Ø 550-600 mm

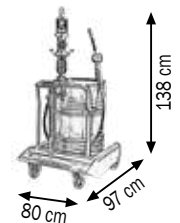

**022-3125-000**

## Art. 022-3125-000

Wall-fixing oil kit industrial pump for drums 180-220 l

Composed by:

Art.021-0908-000 Air-operated industrial oil pump **ratio=8:1 40 l/min**

Art.025-1265-010 Wall-fixing bracket with anti-vibration rubber spacers

Art.025-1280-094 Ø 50 mm suction tube 940 mm lenght

Art.025-1264-000 Ø 50 mm threaded ring

Art.906-0738-020 1SC 1.1/4" hose F 1.1/2 90° - F 1.1/2" 2,0 m length

Art.F96-0100-806 Nipple M 1.1/2"-M 1"



**022-3125-000** 39,730 0,176 3

Ø 550-600 mm

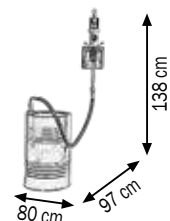

## Art. 022-3130-000

Wall-fixing oil kit industrial pump for IBC tanks 700-1000 l

Composed by:

- Art.021-0905-000 Air-operated industrial oil pump **ratio=5:1 50 l/min**
- Art.025-1265-010 Wall-fixing bracket with anti-vibration rubber spacers
- Art.025-1280-125 Ø 50 mm suction tube 1250 mm length
- Art.025-1264-000 Ø 50 mm threaded ring
- Art.906-0738-020 1SC 1.1/4" hose F 1.1/2 90° - F 1.1/2" 2,0 m length
- Art.F96-0100-806 Nipple M 1.1/2"-M 1"
- Art.025-1267-000 Fixing tank bracket



**022-3130-000**

The tank is not included in the oil kit

<b>022-3130-000</b>	52,430	0,280	4



## Art. 022-3135-000

Wall-fixing oil kit industrial pump for IBC tanks 700-1000 l

Composed by:

- Art.021-0905-000 Air-operated industrial oil pump **ratio=5:1 50 l/min**
- Art.025-1265-010 Wall-fixing bracket with anti-vibration rubber spacers
- Art.025-1280-125 Ø 50 mm suction tube 1250 mm length
- Art.025-1264-000 Ø 50 mm threaded ring
- Art.906-0738-020 1SC 1.1/4" hose F 1.1/2 90° - F 1.1/2" 2,0 m length
- Art.F96-0100-806 Nipple M 1.1/2"-M 1"
- Art.025-1267-000 Fixing tank bracket
- Art.906-0525-015 1SC 3/4" hose F 3/4" 90° - F 3/4" 1,5 m length
- Art.071-1406-515 Swiveling hose reel with 1SC 3/4" hose 15,0 m l
- Art.024-1245-G00 High delivery oil **digital** dispensing nozzle
- Art.024-1785-000 Support for picking up drops



**022-3135-000**

The tank is not included in the oil kit

<b>022-3135-000</b>	94,000	0,450	6

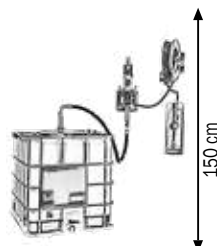

It is a modular solution that allows the oil delivery with connection to a centralized system, to a hose reel or directly to the delivery hose.



022-3500-000

## Art. 022-3500-000

Oil electric pump kit 12V for drums 180-220 l

Composed by:

- Art.091-5480-010 Electric pump for oils **12V** 10 l/min
- Art.025-1270-094 Suction shank hose kit for drums 180-220 l
- Art.906-0404-030 1SC 1/2" M-F hose 3,0 m length
- Art.F96-0100-504 Reduced nipple M 3/4" BSP - M 1/2" BSP
- Art.R18-0855-255 Brass connection fixed rubber M3/4" Ø 25 mm
- Art.024-1231-C00 Oil dispensing nozzle flexible automatic drop valve



Ø 550-600 mm



## Art. 022-3502-000

Oil electric pump kit 24V for drums 180-220 l

Composed like Art.022-3500-000 but with:

- Art.091-5482-010 Electric pump for oils **24V** 10 l/min



Ø 550-600 mm



022-3510-000

## Art. 022-3510-000

Oil electric pump kit 12V for drums 180-220 l

Composed by:

- Art.091-5482-010 Electric pump for oils **12V** 10 l/min
- Art.025-1270-094 Suction shank hose kit for drums 180-220 l
- Art.906-0404-030 1SC 1/2" M-F hose 3,0 m length
- Art.F96-0100-504 Reduced nipple M 3/4" BSP - M 1/2" BSP
- Art.R18-0855-255 Brass connection fixed rubber M3/4" Ø 25 mm
- Art.024-1233-C00 Oil **digital** dispensing nozzle flexible autom. drop valve



Ø 550-600 mm

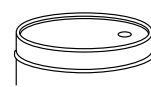

## Art. 022-3512-000

Oil electric pump kit 24V for drums 180-220 l

Composed like Art.022-3510-000 but with:

- Art.091-5482-010 Electric pump for oils **24V** 10 l/min



Ø 550-600 mm



Article	Flow rate	Voltage	Power	Electricity	Cable l.	Inlet-Outlet	Duty cycle
<b>Technical Data:</b>	<b>l/min</b>	<b>AC V.Hz DC Volt</b>	<b>W</b>	<b>A</b>	<b>m</b>	<b>BSPG</b>	<b>min</b>
022-3500-000	10	12	300	35	2	F3/4" F3/4"	S2 30 min
022-3502-000	10	24	300	18	2	F3/4" F3/4"	S2 30 min
022-3510-000	10	12	300	35	2	F3/4" F3/4"	S2 30 min
022-3512-000	10	24	300	18	2	F3/4" F3/4"	S2 30 min

# WHEELED OIL ELECTRIC PUMP KITS FOR LUBRICANT WITH MAXIMUM VISCOSITY 500 cSt



## Art. 022-3525-000

### Oil electric pump kit 230V for drums 180-220 l

Composed by:

- Art.091-5500-025 Electric pump for oils 230V 25 l/min
- Art.030-1398-000 3-wheels trolley
- Art.025-1270-094 Suction shank hose kit for drums 180-220 l
- Art.906-0404-030 1SC 1/2" M-F hose 3,0 m lenght
- Art.F96-0100-604 Reduced nipple M 1" BSP x M 1/2" BSP
- Art.R18-0855-256 Brass connection fixed rubber M1" Ø 25 mm
- Art.R18-1251-006 N.2 STAINLESS STEEL connection 90° F-F 1"
- Art.024-1233-C00 Oil **digital** dispensing nozzle flexible autom. drop valve

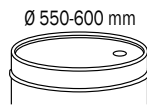

022-3525-000 45,000 0,225 3



022-3525-000

## Art. 022-3550-000

### Oil electric pump kit 230V for drums 180-220 l

Composed by:

- Art.091-5500-050 Electric pump for oils 230V 50 l/min
- Art.030-1398-000 3-wheels trolley
- Art.092-5130-000 Digital flow meter MGE-110
- Art.F96-0100-606 Steel nipple M 1" BSP x M 1" BSP
- Art.R18-1251-006 L shaped elbow 90° M-F 1"
- Art.025-1270-094 Suction shank hose kit for drums 180-220 l
- Art.908-0516-040 Rubber hose 10 bar 19x27 M-M 1" 4,0 m lenght
- Art.R18-0855-256 Brass connection fixed rubber M1" Ø 25 mm
- Art.093-5202-000 Aluminium manual nozzle MC100

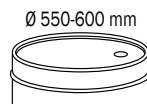

022-3550-000 47,300 0,225 3



022-3550-000

## Art. 022-3560-000

### Oil electric pump kit 230V for drums 180-220 l and IBC tank

Composed by:

- Art.091-5500-025 Electric pump for oils 230V 25 l/min
- Art.091-6000-000 Universal support plate with handle for electric pumps
- Art.025-1270-125 Suction shank hose kit for drums 180-220 l IBC tank
- Art.906-0404-030 1SC 1/2" M-F hose 3,0 m lenght
- Art.F96-0100-604 Reduced nipple znt M 1" BSP x M 1/2" BSP
- Art.R18-0855-256 Brass connection fixed rubber M1" Ø 25 mm
- Art.024-1233-C00 Oil **digital** dispensing nozzle flexible autom. drop valve

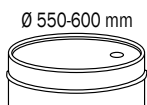

022-3560-000 30,000 0,070 3

022-3565-000 29,300 0,070 3



022-3560-000

The tank is not included in the oil kit

Article	Flow rate	Voltage	Power	Electricity	Cable l.	Inlet-Outlet	Duty cycle
<b>Technical Data:</b>	<b>l/min</b>	<b>AC V.Hz</b>	<b>W</b>	<b>A</b>	<b>m</b>	<b>BSPG</b>	<b>min</b>
091-5500-025	25	230/250	828	4,6	2	F 1"-F 1"	continuous
091-5500-050	50	230/50	1081	7	2	F 1"-F 1"	continuous



**Art. 090-8070-000**

**Art. 090-8070-000**

**Double-wall tank "Multitank" 700 l**

For the storage of oil, diesel fuel, bio diesel  
Double-wall tanks in HDPE with integrated galvanised steel foil  
Palletised base, built-in transport handles  
Level indicator  
Visual leaks detector  
For professional or private use  
Approved for indoor installation



**090-8070-000** 65,000 1,030 1

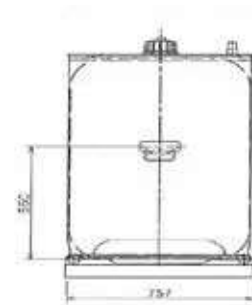
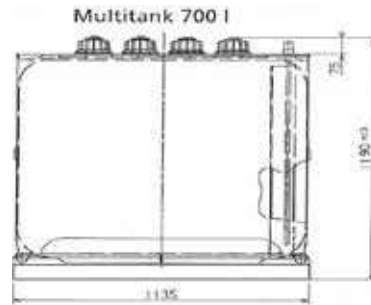

**Art. 090-8100-000**

**Art. 090-8100-000**

**Double-wall tank "Multitank" 1000 l**

For the storage of oil, diesel fuel, bio diesel  
Double-wall tanks in HDPE with integrated galvanised steel foil  
Palletised base, built-in transport handles  
Level indicator  
Visual leaks detector  
For professional or private use  
Approved for indoor installation



**090-8100-000** 80,000 1,370 1

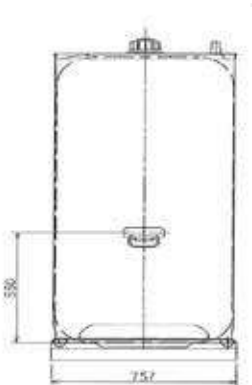
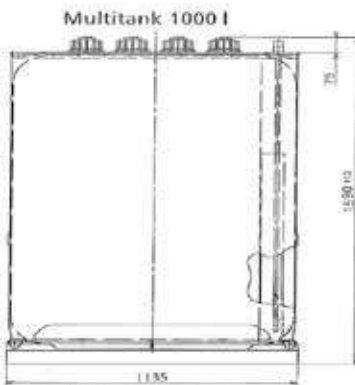

**090-8200-030**

**Art. 090-8200-030**

**Support bracket for pump - hose reel**

Painted steel with F 2" G ring nut

Hose reel, pump, nozzle and accessories are not included



**090-8200-030** 12,500 0,044 1

Article	Description	Capacity	Width	Depth	Height	Weight	Packaging
		l	mm	mm	mm	kg	mm
<b>090-8070-000</b>	Multitank	<b>700</b>	1135	757	1190	65	113x757x1190
<b>090-8100-000</b>	Multitank	<b>1000</b>	1135	757	1590	80	113x757x1590
<b>090-8200-030</b>	Supp.bracket	-	727	370	114	12,5	745X390X150

# DOUBLE-WALL POLYETHYLENE TANKS FOR OIL, DIESEL, BIO-DIESEL, AdBlue®

## “ Tank in Tank ”



### Art. 090-9100-000

#### Double-wall polyethylene “Tank in Tank” 1000 l

For the storage of oil, diesel fuel, bio diesel, AdBlue®

Double-wall rigid polyethylene

Integrated retention basin

Built-in transport handles

Level indicator

UV protection anti-odor barrier SMP

Reinforcement pipes in galvanized steel

Approved for indoor installation



090-9100-000 59,000 1,580 1



1000 l

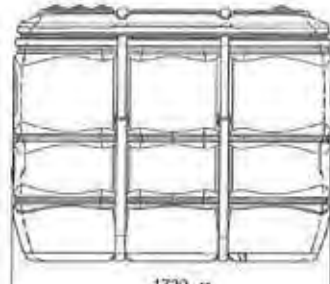
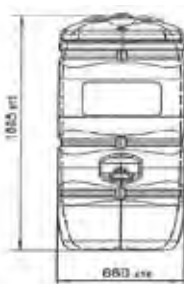

1500 l



Art. 090-9100-000

### Art. 090-9150-000

#### Double-wall polyethylene “Tank in Tank” 1500 l

For the storage of oil, diesel fuel, bio diesel, AdBlue®

Double-wall rigid polyethylene

Integrated retention basin

Built-in transport handles

Level indicator

UV protection anti-odor barrier SMP

Reinforcement pipes in galvanized steel

Approved for indoor installation



090-9150-000 90,000 2,280 1

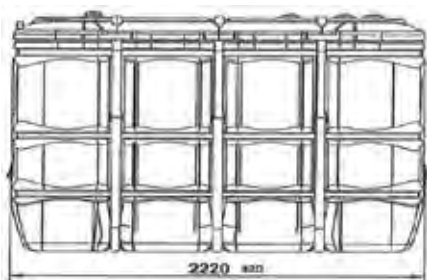

2000 l



Art. 090-9150-000

### Art. 090-9200-000

#### Double-wall polyethylene “Tank in Tank” 2000 l

For the storage of oil, diesel fuel, bio diesel, AdBlue®

Double-wall rigid polyethylene

Integrated retention basin

Built-in transport handles

Level indicator

UV protection anti-odor barrier SMP

Reinforcement pipes in galvanized steel

Approved for indoor installation



090-9200-000 145,00 2,860 1



Art. 090-9200-000

Article	Description	Capacity	Width	Depth	Height	Weight	Packaging
		l	mm	mm	mm	kg	mm
090-9100-000	Tank in Tank	1000	1420	660	1685	59	1420x660x1685
090-9150-000	Tank in Tank	1500	1720	770	1700	90	1720x770x1720
090-9200-000	Tank in Tank	2000	2200	770	1685	145	2200x770x1685



**023-1805-000**

**Art. 023-1805-000**

Polyethylene tank of dump and storage for 1 drum of 180-220 l

Composed by:

Removable polypropylene grate

Tank capacity: 225 l

Dimensions: 925 X 800 X H 420 mm



023-1805-000 20,00 0,311 1

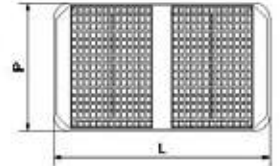
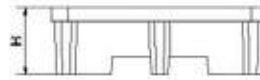

**023-1810-000**

**Art. 023-1810-000**

Polyethylene tank of dump and storage for 2 drums of 180-220 l

Composed by:

Removable polypropylene grate

Tank capacity: 305 l

Dimensions: 1350 X 800 X H 420 mm



023-1810-000 35,00 0,454 1

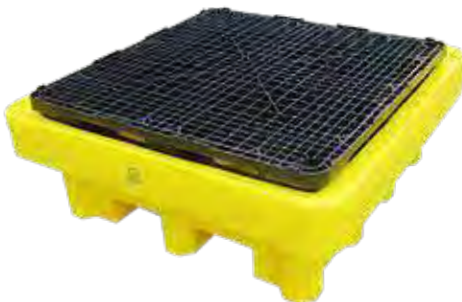
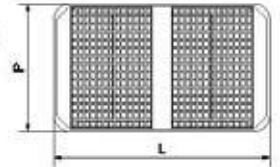

**023-1814-000**

**Art. 023-1814-000**

Polyethylene tank of dump and storage for 4 drums of 180-220 l

Composed by:

Removable polypropylene grate

Tank capacity 500 l

Dimensions: 1350 X 1350 X H 490 mm



023-1814-000 52,00 0,735 1

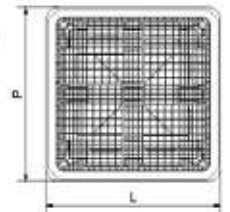
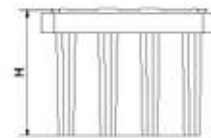

**023-1815-000**

**Art. 023-1815-000**

Polyethylene tank of dump and storage for 1 tank of 1000 l

Composed by:

Removable polypropylene grate

Tank capacity: 1050 l

Dimensions: 1350 X 1350 X H 970 mm



023-1815-000 90,00 1,77 1

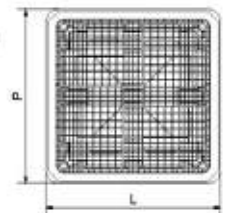
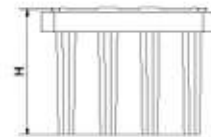

These polyethylene tanks are treated to resist to UV rays and equipped with removable polypropylene grata they are suitable for the storage of metal drums of lubricants and simply transportable with fork truck or trans pallet, the storage of lubricant drums in the industrial environment and in repair shops must have a tank to collect the accidental overflowing, avoiding the dispersion in the environment. It's important to put the tanks on plain surfaces, protected by the rain. If the storing of different substances is required, these ones shall be reciprocally compatible.

## Art. 023-1825-000

**Polyethylene horizontal support to store 1 drum of 180-220 l**

It can be positioned directly on the safety tanks  
It can be used to place a 220 l drum horizontally  
or, by turning it upside down, a 50 l drum



Art. 023-1825-000

023-1825-000	10,00	0,12	1

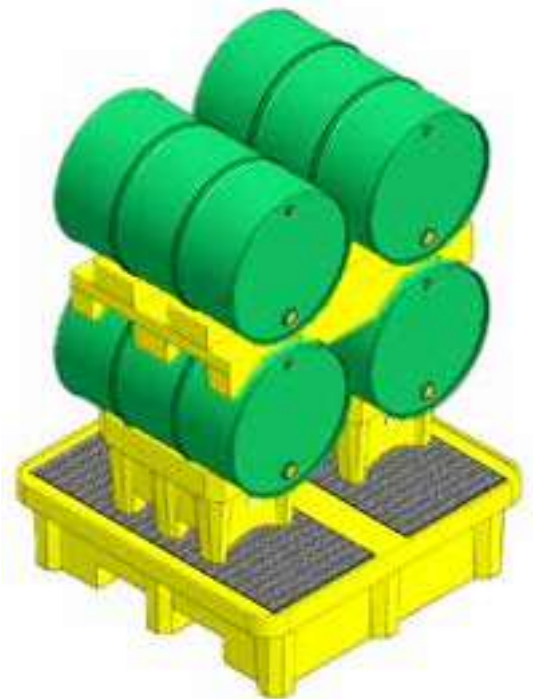
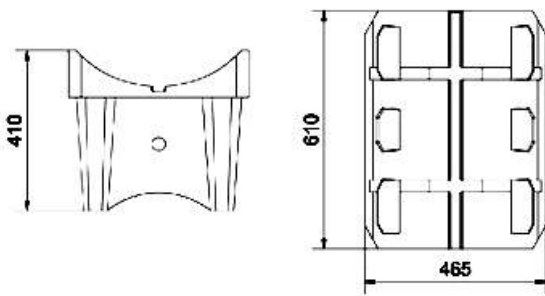

## Art. 023-1830-000

**Polyethylene horizontal support to store 2 drums of 180-220 l**

It can be positioned directly on the safety tanks  
to place two 220 l drums horizontally  
usable together with the 50/220 model  
to stack 220 l drums

023-1830-000	30,00	0,24	1

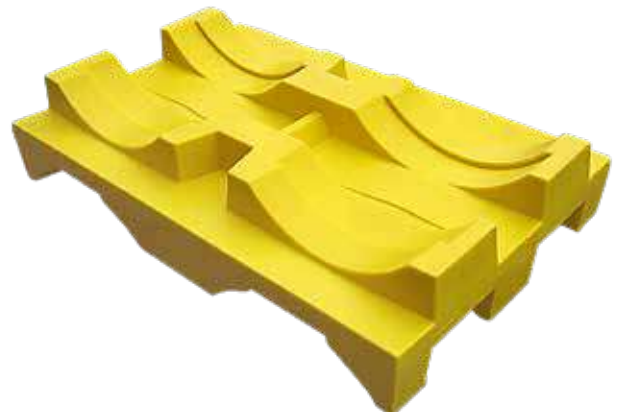

Art. 023-1830-000

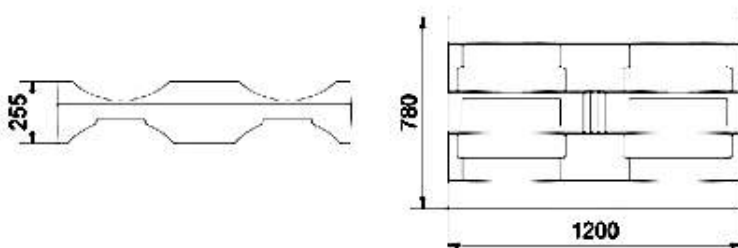



**023-1905-000**

## Art. 023-1905-000

Tank of dump and storage for 1 drum of 180-220 l



023-1905-000 49,300 0,270 1



**023-1910-000**

## Art. 023-1910-000

Tank of dump and storage for 2 drums of 180-220 l



023-1910-000 62,600 0,363 1



**023-1914-000**

## Art. 023-1914-000

Tank of dump and storage for 4 drums of 180-220 l



023-1914-000 119,000 0,573 1



**023-1915-000**

## Art. 023-1915-000

Tank of dump and storage for 1 tank of 1000 l



023-1915-000 182,500 1,422 1

Technical data		023-1905-000	023-1910-000	023-1914-000	023-1915-000
Capacity	n°	1 drum 180/220 l	2 drums 180/220 l	4 drums 180/220 l	1 tank da 1000 l
Dimensions	mm	1000x850 H 300	1350x850 H 300	1350x1350 H 300	1650x1350 H 620



**023-1920-000**

## Art. 023-1920-000

Horizontal support to store 1 drum of 180-220 l



023-1920-000 14,500 0,145 1



**023-1921-000**

## Art. 023-1921-000

Horizontal support to store 2 drums of 180-220 l



023-1921-000 22,000 0,283 1



**023-1922-000**

## Art. 023-1922-000

Horizontal support to store 3 drums of 50-60 l



023-1922-000 22,200 0,283 1

Technical data		023-1920-000	023-1921-000	023-1922-000
Capacity	n°	1 drum 180/220 l	2 drums 180/220 l	3 drums 50/60 l
Dimensions	mm	600x600 H 380	1180x600 H 380	1180x600 H 380

These steel tanks are suitable for the storage of metal drums of lubricants and simply transportable with fork truck or trans pallet. The tanks are produced with strong metal, reinforced with frames in shapes, the grates are galvanized. According to the new rules, the stocking of lubricant drums in the industrial environment and in repair shops must have a tank to collect the accidental overflowing, avoiding the dispersion in the environment. It's important to put the tanks on plain surfaces, protected by the rain. If the storing of different substances is required, these ones shall be reciprocally compatible.

## Art. 023-1925-000

Tank of dump complete with supporting structure for 1 drum of 180-220 l

Composed by:

Art.023-1905-S00 Tank of dump for 1 drum 180-220 l

Art.023-1916-000 N.2 Vertical posts H. 2,20 m

Art.023-1918-000 N.2 Horizontal drill panels 770x240 mm

023-1925-000	82,200	0,304	2

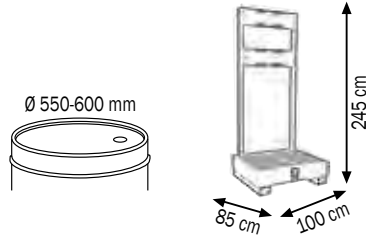

023-1925-000

## Art. 023-1930-000

Tank of dump complete with supporting structure for 2 drums of 180-220 l

Composed by:

Art.023-1910-S00 Tank of dump for 2 drums 180-220 l

Art.023-1916-000 N.2 Vertical posts H. 2,20 m

Art.023-1919-000 N.2 Horizontal drill panels 1110x240 mm

023-1930-000	97,700	0,405	2

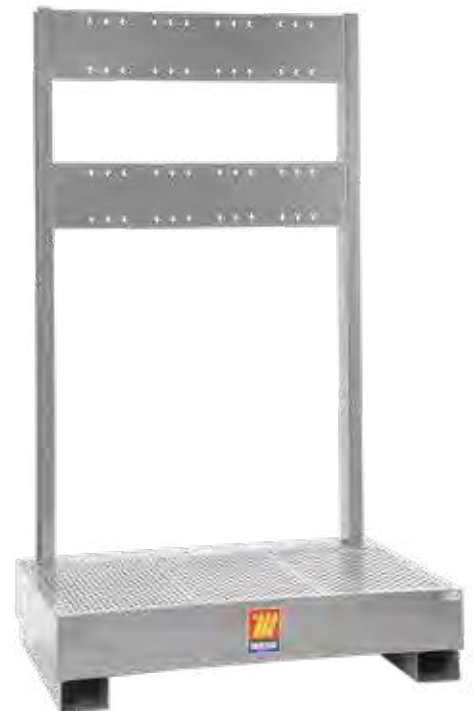
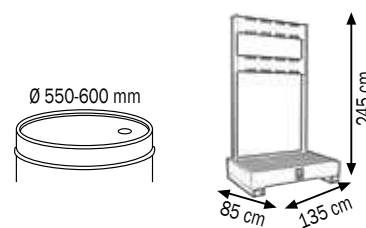

023-1930-000

These steel tanks are suitable for the storage of metal drums of lubricants and are simply transportable with a fork truck or trans pallet. The tanks are produced with strong metal, reinforced with frames in shapes, the grates are galvanized. According to the new rules, the stocking of lubricant drums in the industrial environment and in repair shops must have a tank to collect the accidental overflowing, avoiding the dispersion in the environment. It's important to put the tank on plain surfaces, protected by the rain. If the storing of different substances is required, these ones shall be reciprocally compatible. The tanks of dump with supporting structure is suitable to support the equipment for the distribution of lubricants for different uses (industrial environment or repair shops).



**023-1935-000**

## Art. 023-1935-000

Complete installation for 1 drum of 180-220 l

Composed by:

Art.020-1195-000 Air-operated oil pump **ratio=3:1 30 l/min**

Art.023-1925-000 Tank of dump complete with supporting structure

Art.070-1206-410 Hose reel with 1SC 1/2" hose F-F 10,0 m length

Art.906-0424-015 1SC 1/2 " hose F-F 1,5 m length

Art.024-1233-C00 Oil **digital** dispensing nozzle

## Art. 023-1937-000

Complete installation for 1 drum of 180-220 l

Composed like Art.023-1935-000 but with:

Art.020-1205-000 Air-operated oil pump **ratio=5:1 28 l/min**



<b>023-1935-000</b>	109,500	0,387	5
---------------------	---------	-------	---

<b>023-1937-000</b>	109,600	0,387	5
---------------------	---------	-------	---

Ø 550-600 mm

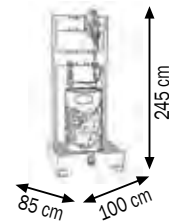

## Art. 023-1940-000

Complete installation for 1 drum of 180-220 l

Composed by:

Art.020-1188-000 Air-operated oil pump **ratio=3:1 30 l/min**

Art.023-1925-000 Tank of dump complete with supporting structure

Art.074-4506-410 Closed hose reel with 1SC 1/2" hose 10,0 m length

Art.025-1265-000 Wall fixing bracket

Art.025-1268-094 Shank Ø 42 mm 940 mm length

Art.025-1262-000 Drum connection Ø 42 mm

Art.910-0600-020 Flexible hose Ø 1" 2 m length

Art.B27-1132-035 N.2 stainless steel screw clamps 32-35 mm

Art.906-0434-008 1SC 1/2" hose F-F 90° 0,8 m length

Art.024-1233-C00 Oil **digital** dispensing nozzle

## Art. 023-1942-000

Complete installation for 1 drum of 180-220 l

Composed like Art.023-1940-000 but with:

Art.020-1198-000 Air-operated oil pump **ratio=5:1 28 l/min**



**023-1940-000**



<b>023-1940-000</b>	123,000	0,414	5
---------------------	---------	-------	---

<b>023-1942-000</b>	123,200	0,414	5
---------------------	---------	-------	---

Ø 550-600 mm

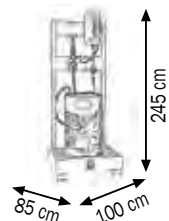

Fixed and complete positions that offer an independent working station. They allow an optimal placing in every working environment (factories and repair shops) allowing to operate in a clean and safe way and without wasting of lubricant oils for different uses.

## Art. 023-1945-000

Complete installation for 2 drums of 180-220 l

Composed by:

Art.020-1195-000 N.2 Air-operated oil pumps **ratio=3:1 30 l/min**

Art.023-1930-000 N.1 Tank of dump complete with supporting structure

Art.070-1206-410 N.2 Hose reels with 1SC 1/2" hose 10,0 m length

Art.906-0424-015 N.2 1SC 1/2" hose F-F 1,5 m length

Art.024-1233-C00 N.2 Oil **digital** dispensing nozzles

## Art. 023-1947-000

Complete installation for 2 drums of 180-220 l

Composed like Art.023-1945-000 but with:

Art.020-1205-000 n.2 Air-operated oil pumps **ratio=5:1 28 l/min**

023-1945-000	152,100	0,553	7
023-1947-000	152,800	0,553	7

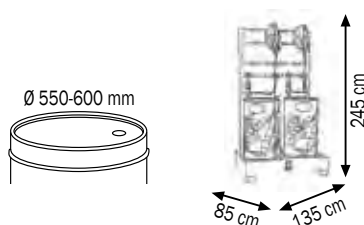

023-1945-000

## Art. 023-1950-000

Complete installation for 2 drums of 180-220 l

Composed by:

Art.020-1188-000 N.2 Air-operated oil pumps **ratio=3:1 30 l/min**

Art.023-1930-000 N.1 Tank of dump complete with supporting structure

Art.074-4506-410 N.2 Closed hose reel with 1SC 1/2" hose 10,0 m length

Art.025-1265-000 N.2 Wall fixing brackets

Art.025-1268-094 N.2 Shanks Ø 42 mm 940 mm length

Art.025-1262-000 N.2 Drums connection Ø 42 mm

Art.910-0600-020 N.2 Flexible hoses Ø 1" 2,0 m length

Art.B27-1132-035 N.4 stainless steel screw clamps 32-35 mm

Art.906-0434-008 N.2 1SC 1/2" hose F-F 90° 0,8 m length

Art.024-1233-C00 N.2 Oil **digital** dispensing nozzles

## Art. 023-1952-000

Complete installation for 2 drums of 180-220 l

Composed like Art.023-1950-000 but with:

Art.020-1198-000 N.2 Air-operated oil pumps **ratio=5:1 28 l/min**

023-1950-000	179,300	0,607	7
023-1952-000	179,700	0,607	7

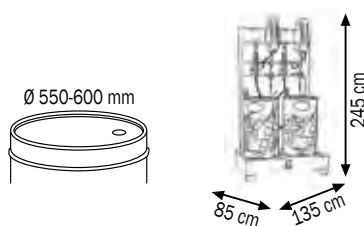

023-1950-000

Fixed and complete positions that offer an independent working station. They allow an optimal placing in every working environment (factories and repair shops) allowing to operate in a clean and safe way and without wasting of lubricant oils for different uses.



**023-1963-004**

**Art. 023-1963-004**

**Support structure for 4 hose reels Mod. F-400 F-460 CF-500**

Composed by:

Drip tray

Support with grate

Dimensions 1130X600 H.2500 mm



**023-1963-004** 192,000 0,900 2

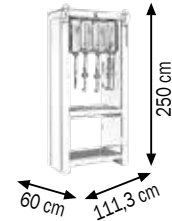

The hose reels aren't included in the cabinets

**Art. 023-1964-006**

**Support structure for 6 hose reels Mod. F-400 F-460 CF-500**

Composed by:

Drip tray

Support with grate

Dimensions 1550X600 H.2500 mm



**023-1964-006** 215,000 1,000 2

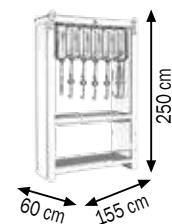

**023-1964-006**

These structures will be supplied only and exclusively in grey colour RAL 9007

Fixed cabinets that offer independent working stations. They allow an optimal placing in every working environment (factories and repair shops) allowing to operate in a clean and safe way and without wasting of lubricant oils for different uses.

This fixed cabinets can be connected to a centralized distribution system and become individual working station.

## Art. 023-1963-C04

Cabinet structure for 4 hose reels Mod. F-400 F-460 CF-500

Composed by:

Drip tray

Support with grate

2 Doors with closure

Dimensions 1130X600 H.2500 mm



023-1963-C04 234,000 1,000 3

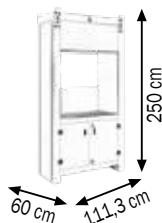

023-1963-C04

## Art. 023-1964-C06

Cabinet structure for 6 hose reels Mod. F-400 F-460 CF-500

Composed by:

Drip tray

Support with grate

2 Doors with closure

Dimensions 1550X600 H.2500 mm



023-1964-C06 262,000 1,100 3



023-1964-C06

These structures will be supplied only and exclusively in grey colour RAL 9007

Fixed cabinets that offer independent working stations. They allow an optimal placing in every working environment (factories and repair shops) allowing to operate in a clean and safe way and without wasting of lubricant oils for different uses.

This fixed cabinets can be connected to a centralized distribution system and become individual working station.



**023-1965-004**

**Art. 023-1965-004**

**Support structure for 4 hose reels Mod. F-550 F-555**

Composed by:

Drip tray

Support with grate

Dimensions 1650X600 H.2500 mm



023-1965-004 225,00 1,000 2

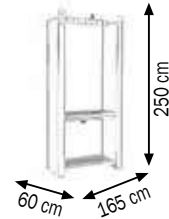

**023-1965-006**

**Art. 023-1965-006**

**Support structure for 6 hose reels Mod. F-550 F-555**

Composed by:

Drip tray

Support with grate

Dimensions 2310X600 H.2500 mm



023-1965-006 245,00 1,100 2

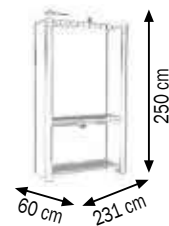

These structures will be supplied only and exclusively in grey colour RAL 9007

Fixed cabinets that offer independent working stations. They allow an optimal placing in every working environment (factories and repair shops) allowing to operate in a clean and safe way and without wasting of lubricant oils for different uses.

This fixed cabinets can be connected to a centralized distribution system and become individual working station.

## Art. 023-1966-000

Cabinet structure for oil distribution  
Dimensions 1600X700 H 2500 mm

Composed by:

Tank of dump for 2 drums of 180-220 L

2 Doors with closure for drums

Work sur face 1600X700 mm

Panel for tools

Cabinet structure for 4 hose reels Mod. F-400 F-460 CF-500



023-1966-000

023-1966-000	316,000	1,170	4

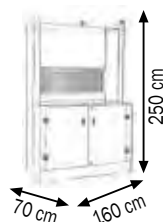

## Art. 023-1967-000

Complete cabinet installation oil distribution

For 2 drums of 180-220 l

Composed by:

Art.023-1966-000 N.1 Frame cabinet

Art.020-1195-000 N.2 Air-operated oil pumps **ratio=3:1 30 l/min**

Art.074-4506-410 N.2 Closed hose reels R1 1/2" 10 m

Art.906-0424-015 N.2 1SC 1/2" hose 1,5 m length

Art.053-1537-000 N.2 Spring hose rilsan 6X8 10 m

Art.024-1233-C00 N.2 Oil **digital** dispensing nozzles

Art.014-1048-B00 N.1 Pressure regulator with filter, lubricator and gauge 1/2"



023-1967-000

023-1967-000	392,000	2,970	9

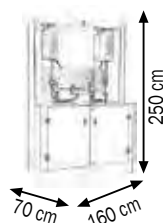

Frame cabinet for oil distribution able to provide an autonomous operating station.

They can be easily placed in every working environment (factories, garages and repair shops).

Allowing clean and safe supply without wasting of lubricant oils for different uses.

The base is composed by a tank of dump and stocking for 2 drums of 180-220 L as the new regulations upon.

The cabinet is pre-arranged for max 4 hose reels and have a worktop of 1600X700 mm.

## Art. 023-1968-001

### Front-end service with support for 1 hose reel

It is predisposed universal holes that allow the application of pump, hose reels and support for drops collection

## Art. 023-1968-002

### Front-end service with support for 2 hose reels

Composed by:

Art.023-1968-001 Front-end service

Art.079-1779-002 Panel support for 2 hose reels

Art.023-1960-002 Pair of support brackets for 2 drip tray

023-1968-001



023-1968-002



023-1968-001	62,000	0,36	2
023-1968-002	64,300	0,38	2

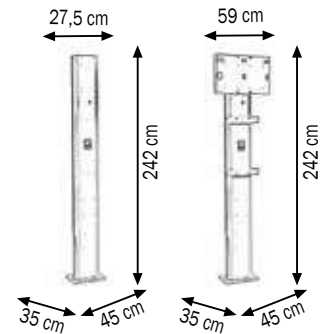

## Art. 023-1968-003

### Front-end service support for 3 hose reels

Composed by:

Art.023-1968-001 Front-end service

Art.079-1779-003 Panel support for 3 hose reels

Art.023-1960-003 Pair of support brackets for 3 drip tray

## Art. 023-1968-004

### Front-end service support for 4 hose reels

Composed by:

Art.023-1968-001 Front-end service

Art.079-1779-004 Panel support for 4 hose reels

Art.023-1960-004 Pair of support brackets for 4 drip tray

023-1968-003



023-1968-004



023-1968-003	67,800	0,39	2
023-1968-004	76,500	0,40	2

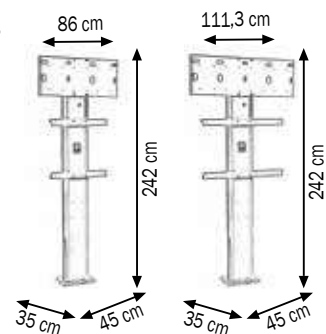

Fixed supports that offer an independent working station. They allow an optimal placing in every working environment (factories and repair shops) allowing to operate in a clean and safe way and without wasting of lubricant oils for different uses.

## Art. 023-1970-000

### 3 sides service support

It is predisposed of universal hole that allows the application of hose reels, pumps, picking up drops

## Art. 023-1972-000

### Service support for oil distribution 1 position

Composed by:

Art.023-1970-000 Service support

Art.070-1206-410 Fixed hose reel with hose 1SC 1/2" 10,0 m length

Art.906-0424-006 Hose 1SC 1/2" F-F 600 mm length

Art.024-1233-C00 Oil digital dispensing nozzle

Art.024-1785-000 Drip tray

023-1970-000	77,000	0,560	1	
023-1972-000	102,350	0,650	3	

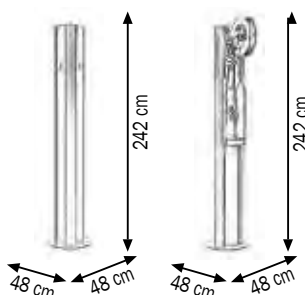

## Art. 023-1974-000

### Service support for oil distribution 2 position

Composed by:

Art.023-1970-000 N.1 Service support

Art.070-1206-410 N.2 Fixed hose reel with hose 1SC 1/2" 10,0 m length

Art.906-0424-006 N.2 Hoses 1SC 1/2" F-F 600 mm length

Art.024-1233-C00 N.2 Oil digital dispensing nozzles

Art.024-1785-000 N.2 Drip tray

023-1974-000	126,450	0,700	5	

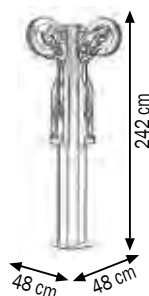

Fixed supports that offer an independent working station. They allow an optimal placing in every working environment (factories and repair shops) allowing to operate in a clean and safe way and without wasting of lubricant oils for different uses.



**023-1969-008**

**Art. 023-1969-008**

Support bilateral frame for 8 hose reels Mod. F-400 F-460 CF-500

Composed by:

Central support column

Fixing post for 8 hose reels

N.2 Drip tray

Dimensions 2500x500 H 2620 mm



<b>023-1969-008</b>	295,00	1,03	3
---------------------	--------	------	---

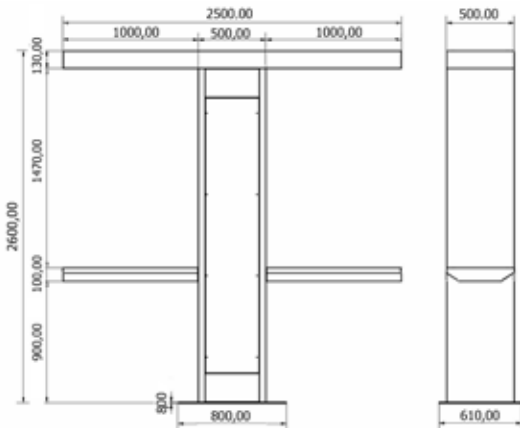

Support bilateral frame eight hose reels that offer an independent working station. It allows an optimal placing in every working environment (factories and repair shops) allowing to operate in a clean and safe way and without wasting of lubricant oils for different uses.

# NOZZLES FOR DISTRIBUTION AND MEASUREMENT OF OIL AND SIMILAR FLUIDS





**024-1231-000**

**Art. 024-1231-000**

Handle for oil dispensing nozzle

Composed by:

Aluminium body

Button to block the lever

F 1/2" swivel joint



**024-1231-A00**

**Art. 024-1231-A00**

Oil dispensing nozzle

Composed by:

Handle with F 1/2" swivel joint

Flexible end 105°

Manual drop valve Ø 12 mm



**024-1231-B00**

**Art. 024-1231-B00**

Oil dispensing nozzle

Composed by:

Handle with F 1/2" swivel joint

Rigid end 45°

Manual drop valve Ø 12 mm

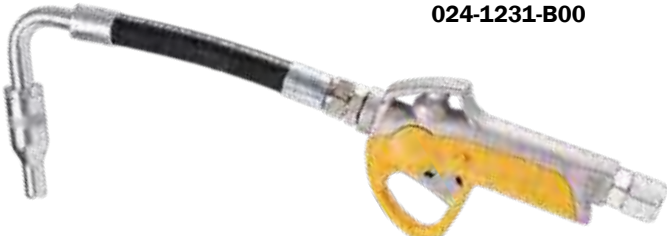

**024-1231-C00**

**Art. 024-1231-C00**

Oil dispensing nozzle

Composed by:

Handle with F 1/2" swivel joint

Flexible end 105°

Automatic drop valve Ø 14 mm



**024-1231-D00**

**Art. 024-1231-D00**

Oil dispensing nozzle

Composed by:

Handle with F 1/2" swivel joint

Rigid end 45°

Automatic drop valve Ø 14 mm



**024-1232-F00**

**Art. 024-1232-F00**

Oil dispensing nozzle

Composed by:

Handle with F 1/2" swivel joint

Flexible end 105°

Manual drop valve Ø 12 mm



**024-1232-G00**

**Art. 024-1232-G00**

Oil dispensing nozzle

Composed by:

Handle with F 3/8" swivel joint

Rigid end 30°

Automatic drop valve Ø 14 mm



**024-1232-E00**

**Art. 024-1232-E00**

Oil dispensing nozzle

Composed by:

Handle with F 3/8" swivel joint

Flexible end

Manual drop valve Ø 12 mm

## Art. 024-1233-A00

### Oil digital dispensing nozzle

Composed by:

Oil digital flow meter (Art.024-1234-000)

Rubber protection

Handle with F 1/2" swivel joint

**Flexible end 105°**

Manual drop valve Ø 12 mm



024-1233-A00

## Art. 024-1233-B00

### Oil digital dispensing nozzle

Composed by:

Oil digital flow meter (Art.024-1234-000)

Rubber protection

Handle with F 1/2" swivel joint

**Rigid end 45°**

Manual drop valve Ø 12 mm



024-1233-B00

## Art. 024-1233-C00

### Oil digital dispensing nozzle

Composed by:

Oil digital flow meter (Art.024-1234-000)

Rubber protection

Handle with F 1/2" swivel joint

**Flexible end 105°**

Automatic drop valve Ø 14 mm



024-1233-C00

## Art. 024-1233-D00

### Oil digital dispensing nozzle

Composed by:

Oil digital flow meter (Art.024-1234-000)

Rubber protection

Handle with F 1/2" swivel joint

**Rigid end 45°**

Automatic drop valve Ø 14 mm



024-1233-D00

## Art. 024-1234-000

### Oil digital flow meter

It is equipped with two displays, one for partial measures (resettable) and one for total measures (not resettable) of the dispensed fluid



024-1234-000

Technical Data	024-1234-000
Inlet/outlet connection	F 1/2" BSP
Pressure min/max	0,35 - 70 bar
Flow min/max	1 - 30 l/min
Temperature	-10° + 50° C
Accuracy	+/- 0,5%
Lithium battery	2 x 1,5V AAA

### FEATURES

- Easy calibration
- Double totalizer
- Electronic reset
- High precision
- Ergonomic grip
- Button to block the lever
- Low battery consumption
- Different units of measurements can be selected: litres, pints, quarts or gallons.
- Not approved for public usage



024-1243-A00

### Art. 024-1243-A00

Recalibrating oil digital dispensing nozzle

Composed by:

Oil digital flow meter (Art.024-1246-000)

Rubber protection

Handle with F 1/2" swivel joint

**Flexible end 105°**

Manual drop valve Ø 12 mm



024-1243-B00

### Art. 024-1243-B00

Recalibrating oil digital dispensing nozzle

Composed by:

Oil digital flow meter (Art.024-1246-000)

Rubber protection

Handle with F 1/2" swivel joint

**Rigid end 45°**

Manual drop valve Ø 12 mm



024-1243-C00

### Art. 024-1243-C00

Recalibrating oil digital dispensing nozzle

Composed by:

Oil digital flow meter (Art.024-1246-000)

Rubber protection

Handle with F 1/2" swivel joint

**Flexible end 105°**

Automatic drop valve Ø 14 mm



024-1243-D00

### Art. 024-1243-D00

Recalibrating oil digital dispensing nozzle

Composed by:

Oil digital flow meter (Art.024-1246-000)

Rubber protection

Handle with F 1/2" swivel joint

**Rigid end 45°**

Automatic drop valve Ø 14 mm



024-1246-000

### Art. 024-1246-000

Recalibrating oil digital flow meter

It is equipped with two displays, one for partial measures (resettable) and one for total measures (not resettable) of the dispensed fluid

## FEATURES

- Easy calibration
- Double totalizer
- Electronic reset
- High precision
- Ergonomic grip
- Button to block the lever
- Low battery consumption
- Different units of measurements can be selected: litres, pints, quarts or gallons.
- Not approved for public usage

## Technical Data

## 024-1246-000

Inlet/outlet connection	F 1/2" BSP
Pressure min/max	0,35 - 100 bar
Flow min/max	1 - 35 l/min
Temperature	-10° + 50° C
Accuracy	+/- 0,5%
Lithium battery	1 x 3V CR123A

**Art. 024-1241-E00**

**Oil digital dispensing nozzle MID approved**

Composed by:

Oil digital flow meter (Art.024-1241-MID)

Rubber protection

Handle with F 1/2" swivel joint

**Rigid end 30° 138 mm length**

Automatic drop valve



**024-1241-E00**

**Art. 024-1241-C00**

**Oil digital dispensing nozzle MID approved**

Composed by:

Oil digital flow meter (Art.024-1241-MID)

Rubber protection

Handle with F 1/2" swivel joint

**Flexible end 105°**

Automatic drop valve Ø 14 mm



**024-1241-C00**

**Art. 024-1242-DX0**

**Anti-freeze and windscreen liquid digital dispensing nozzle**

**MID approved** - Composed by:

Oil digital flow meter (Art.024-1242-MID)

Rubber protection

Handle with F 1/2" swivel joint

**Flexible end 45° stainless steel**

Automatic drop valve Ø 13,5 mm



**024-1242-DX0**

**Art. 024-1242-C00**

**Anti-freeze and windscreen liquid digital dispensing nozzle**

**MID approved** - Composed by:

Oil digital flow meter (Art.024-1242-MID)

Rubber protection

Handle with F 1/2" swivel joint

**Flexible end 105°**

Automatic drop valve Ø 12 mm



**024-1242-C00**

**Art. 024-1241-MID**

**Oil digital flow meter MID approved**

It is equipped with two displays, one for partial measures (resettable) and one for total measures (not resettable) of the dispensed fluid



**024-1241-MID**

**Art. 024-1242-MID**

**Oil digital flow meter MID approved**

It is equipped with two displays, one for partial measures (resettable) and one for total measures (not resettable) of the dispensed fluid



**024-1242-MID**

Technical Data	024-1241-MID	024-1242-MID
Inlet/outlet connection	F 1/2" BSP	F 1/2" BSP
Pressure min/max	0,35 - 100 bar	0,35 - 100 bar
Flow min/max	1 - 10 l/min	1 - 10 l/min
Temperature	-10° + 50° C	-10° + 50° C
Accuracy	+/- 0,3%	+/- 0,3%
Lithium battery	1 x 3V CR123A	1 x 3V CR123A

**FEATURES**

- All the digital meters are "OIML R117-1" pre-tested, calibrated and supplied with MID approval.
- Internal data-logger (storage of 500 dispenses with date and time)
- Pulse monitoring (detection of air pockets inside the pipe)
- Electronic display with 3 decimal places
- Tamper-proof due to the sealing of the measuring chamber
- Different units of measurements can be selected: litres, pints, quarts or gallons.



024-1244-G00

**Art. 024-1244-G00**

**High delivery oil dispensing nozzle**  
 Flow rate 90 l/min max press. 100 bar  
 Composed by:  
 Aluminium handle with F 3/4" swivel joint  
 Button to block the lever  
**Flexible end M 3/4"**  
 Semiautomatic drop valve Ø 35 mm



024-1244-H00

**Art. 024-1244-H00**

**High delivery oil dispensing nozzle**  
 Flow rate 90 l/min max press. 100 bar  
 Composed by:  
 Aluminium handle with F 3/4" swivel joint  
 Button to block the lever  
**Rigid end 30°**  
 Semiautomatic drop valve Ø 35 mm



024-1245-G00

**Art. 024-1245-G00**

**High delivery oil digital dispensing nozzle**  
 Flow rate 60 l/min max press. 70 bar  
 Composed by:  
 Oil digital flow meter (Art.024-1245-005)  
 Rubber protection  
 Aluminium handle with F 3/4" swivel joint  
**Flexible end M 3/4"**  
 Semiautomatic drop valve Ø 35 mm



024-1245-H00

**Art. 024-1245-H00**

**High delivery oil digital dispensing nozzle**  
 Flow rate 60 l/min max press. 70 bar  
 Composed by:  
 Oil digital flow meter (Art.024-1245-005)  
 Rubber protection  
 Aluminium handle with F 3/4" swivel joint  
**Rigid end 30°**  
 Semiautomatic drop valve Ø 35 mm



024-1245-005

**Art. 024-1245-005**

**High delivery oil digital flow meter**  
 It is equipped with two displays, one for partial measures (resettable) to 5 digits and one for total measures (not resettable) to 8 digits of the dispensed fluid

**FEATURES**

- Easy calibration
- Double totalizer
- Electronic reset
- High precision
- Ergonomic grip
- Lever block is included
- Low battery consumption
- Different units of measurements can be selected: litres, pints, quarts or gallons.
- Not approved for public usage

Technical Data	024-1245-005
Inlet/outlet connection	F 3/4" BSP
Pressure min/max	0,35 - 70 bar
Flow min/max	6 - 60 l/min
Temperature	-10° + 50° C
Accuracy	+/- 0,5%
Lithium battery	2 x 1,5V AAA

# OIL DISPENSING DIGITAL NOZZLES WITH PRESELECTION FOR OIL AND SIMILAR FLUIDS



## Art. 024-1247-A00

### Oil digital nozzle with PRESELECTION

Composed by:

Oil digital flow meter with preselection delivery

Handle with F 1/2" swivel joint

**Flexible end 105°**

Manual drop valve Ø 12 mm



024-1247-A00

## Art. 024-1247-B00

### Oil digital nozzle with PRESELECTION

Composed by:

Oil digital flow meter with preselection delivery

Handle with F 1/2" swivel joint

**Rigid end 45°**

Manual drop valve Ø 12 mm



024-1247-B00

## Art. 024-1247-C00

### Oil digital nozzle with PRESELECTION

Composed by:

Oil digital flow meter with preselection delivery

Handle with F 1/2" swivel joint

**Flexible end 105°**

Automatic drop valve Ø 14 mm



024-1247-C00

## Art. 024-1247-D00

### Oil digital nozzle with PRESELECTION

Composed by:

Oil digital flow meter with preselection delivery

Handle with F 1/2" swivel joint

**Rigid end 45°**

Automatic drop valve Ø 14 mm



024-1247-D00

## Art. 024-1247-P00

### Oil digital nozzle with PRESELECTION

Composed by:

Oil digital flow meter with preselection delivery

Handle with F 1/2" swivel joint

**Jointed end**

Automatic drop valve Ø 14 mm



024-1247-P00

Technical Data	024-1247-A/B/C/D00	024-1247-P00
Inlet/outlet connection	F 1/2" BSP	F 1/2" BSP
Pressure min/max	0,35 - 70 bar	0,35 - 70 bar
Flow min/max	1 - 35 l/min	1 - 30 l/min
Temperature	-5° + 50° C	-5° + 50° C
Accuracy	+/- 0,5%	+/- 0,5%
Lithium battery	4 x 1,5V AA	4 x 1,5V AA

Oil dispensing gun with PRESELECTION or manual delivery.

The user can calibrate it according to the different units of measurement (litres, gallons, pints).

It is provided calibrated in litres, but it can be easily calibrated by the user.



**024-1249-A00**

**Art. 024-1249-A00**

Oil mechanical nozzle - Composed by:  
Oil mechanic flow meter (Art.024-1249-000)  
Handle with F 1/2" swivel joint  
Flexible end 105°  
Manual drop valve Ø 12 mm



**024-1249-B00**

**Art. 024-1249-AG0**

Oil mechanical nozzle in gallons

**Art. 024-1249-B00**

Oil mechanical nozzle - Composed by:  
Oil mechanic flow meter (Art.024-1249-000)  
Handle with F 1/2" swivel joint  
Rigid end 45°  
Manual drop valve Ø 12 mm

**Art. 024-1249-BG0**

Oil mechanical nozzle in gallons



**024-1249-C00**

**Art. 024-1249-C00**

Oil mechanical nozzle - Composed by:  
Oil mechanic flow meter (Art.024-1249-000)  
Handle with F 1/2" swivel joint  
Flexible end 105°  
Automatic drop valve Ø 14 mm

**Art. 024-1249-CG0**

Oil mechanical nozzle in gallons



**024-1249-D00**

**Art. 024-1249-D00**

Oil mechanical nozzle - Composed by:  
Oil mechanic flow meter (Art.024-1249-000)  
Handle with F 1/2" swivel joint  
Rigid end 45°  
Automatic drop valve Ø 14 mm

**Art. 024-1249-DG0**

Oil mechanical nozzle in gallons



**024-1249-000**

**Art. 024-1249-000**

Oil mechanical flow meter  
It is equipped 3 figures + 1 decimal.  
Display 6 figures rekitable

**Art. 024-1249-G00**

Oil mechanical flow meter in gallons

Technical Data	024-1249-000	024-1249-G00
Inlet/outlet connection	F 1/2" BSP	F 1/2" BSP
Pressure min/max	0,35 - 70 bar	5 - 1000 Psi
Flow min/max	1 - 30 l/min	0,20 - 8 gal/min
Accuracy	+/- 0,1%	+/- 0,1%

**FEATURES**

- Calibration is not necessary
- Easy reset
- Partial and total totalizer
- Not-resettable total totalizer
- Batteries are not necessary
- Mechanical reset button
- Not approved for public usage

# NOZZLES FOR DISPENSING OF ANTI-FREEZE AND WINDSCREEN LIQUID



## Art. 024-1232-H00

Water and anti-freeze liquid dispensing nozzle

Composed by:

Handle with F 3/8" swivel joint

Rigid end 30°



024-1232-H00

## Art. 024-1237-000

Anti-freeze liquid dispensing nozzle

Composed by:

Handle with F 1/2" swivel joint

Flexible end 105°

Manual drop valve Ø 12 mm



024-1237-000

## Art. 024-1237-V00

Windscreen liquid dispensing nozzle

Composed by:

Handle with F 1/2" swivel joint

Rigid end 30° stainless steel



024-1237-V00

## Art. 024-1237-A00

Anti-freeze liquid digital dispensing nozzle

Composed by:

Digital flow meter (Art.024-1238-000)

Rubber protection

Handle with F 1/2" swivel joint

Flexible end 105°

Manual drop valve Ø 12 mm



024-1237-A00

## Art. 024-1237-W00

Windscreen liquid digital dispensing nozzle

Composed by:

Digital flow meter (Art.024-1238-000)

Rubber protection

Handle with F 1/2" swivel joint

Rigid end 30° stainless steel



024-1237-W00

## Art. 024-1238-000

Digital flow meter for anti-freeze and windscreen liquid

It is equipped with two displays, one for partial measures

(resetable) and one for total measures

(not resettable) of the dispensed fluid



024-1238-000

Technical Data	024-1238-000
Inlet/outlet connection	F 1/2" BSP
Pressure min/max	0,35 - 25 bar
Flow min/max	1 - 30 l/min
Temperature	-10° + 50° C
Accuracy	+/- 0,5%
Lithium battery	2 x 1,5V AAA

## FEATURES

- Easy calibration
- Double totalizer
- Electronic reset
- High precision
- Ergonomic grip
- Button to block the lever
- Low battery consumption
- Different units of measurements can be selected: litres, pints, quarts or gallons.
- Not approved for public usage



**024-1251-000**

**Art. 024-1251-000**

High delivery oil digital flow meter

Flow rate **60 l/min**

It is equipped with two displays: one for partial measures (resettable) to 5 digits and one for total measures (not resettable) to 8 digits of the dispensed fluid



**092-5130-000**

**Art. 092-5130-000**

Digital flow meter with gears **MGE-110**

min-max flow rate **5-110 l/min** (lubricants)

6 digits totalizer (not resettable)

6 digits partial (resettable)

Allowed fluids: diesel, oil



**092-5140-000**

**Art. 092-5140-000**

Digital flow meter with gears **MGE-250**

min-max flow rate **10-250 l/min** (lubricants)

6 digits totalizer (not resettable)

6 digits partial (resettable)

Allowed fluids: diesel, oil



**092-5150-000**

**Art. 092-5150-000**

Digital flow meter with gears **MGE-400**

min-max flow rate **15-400 l/min** (lubricants)

6 digits totalizer (not resettable)

6 digits partial (resettable)

Allowed fluids: diesel, oil

Technical Data	024-1251-000	092-5130-000	092-5140-000	092-5150-000
Inlet/outlet connection	F 3/4"-1" BSP	F 1" BSP	F 1.1/2" BSP	F 2" BSP
Pressure min/max	1 - 70 bar	1 - 55 bar	1 - 50 bar	1 - 50 bar
Flow min/max	6 - 60 l/min	5 - 110 l/min	10 - 150 l/min	15 - 300 l/min
Temperature	-10° + 50° C	-10° + 50° C	-10° + 50° C	-10° + 50° C
Accuracy	+/- 0,5%	+/- 0,5%	+/- 0,5%	+/- 0,5%
Lithium battery	2 x 1,5V AAA	1 x 3V CR 2450N	1 x 3V CR 2450N	1 x 3V CR 2450N

The digital flow meters allow to show correctly the push-button delivery, equipped with two displays, one for partial measures resettable and one for total measures not resettable that underlines the dispensed fluid. Suitable for different type of oils, low, medium or high viscosity.

**Art. 024-1255-A00**

Flexible end 105° M 1/2" 256 mm length  
Manual drop valve Ø 12 mm



024-1255-A00

**Art. 024-1255-B00**

Rigid end 45° M 1/2" 256 mm length  
Manual drop valve Ø 12 mm



024-1255-B00

**Art. 024-1255-C00**

Flexible end 105° M 1/2" 256 mm length  
Automatic drop valve Ø 14 mm



024-1255-C00

**Art. 024-1255-D00**

Rigid end 45° M 1/2" 256 mm length  
Automatic drop valve Ø 14 mm



024-1255-D00

**Art. 024-1255-DX0**

Stainless steel rigid end 45° M 1/2" 210 mm length  
Automatic drop valve Ø 13,5 mm



024-1255-DX0

**Art. 024-1255-E00**

Rigid end 30° M 1/2" 138 mm length  
Automatic drop valve Ø 13,5 mm



024-1255-E00

**Art. 024-1256-G00**

High delivery flexible end M 3/4" 310 mm length  
Semiautomatic drop valve Ø 35 mm



024-1256-G00

**Art. 024-1256-H00**

High delivery rigid end 30° M 3/4" 210 mm length  
Semiautomatic drop valve Ø 35 mm



024-1256-H00

**Art. 024-1257-000**

Manual drop valve Ø 12 mm  
with F 1/4" BSP



024-1257-000

**Art. 024-1258-000**

Automatic drop valve Ø 14 mm  
with F 1/4" BSP inlet



024-1258-000

**Art. 024-1258-G00**

Semi-automatic high delivery drop valve Ø 35 mm  
with F 3/4" BSP



024-1258-G00

**Swivelling joints for oil nozzles**

Article	Inlet	Outlet	Max pressure
024-1259-004	M 1/2" BSP	F 1/2" BSP	100
024-1259-005	M 3/4" BSP	F 3/4" BSP	100



024-1259-004



**024-1785-000**

**Art. 024-1785-000**

**Drop collection support for oil nozzle**

Composed by:  
Hook for stop oil nozzle  
Removable drip tray

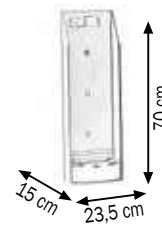

**025-1260-000**

**Art. 025-1260-000**

**Threaded ring M 2" Ø 30 mm for pumps fastening**

With locking wrench  
It connects to either the original drum or the fixing bracket (Art.025-1265-000)



**025-1262-000**

**Art. 025-1262-000**

**Threaded ring M 2" Ø 42 mm for pumps fastening**

With locking wrench  
It connects to either the original drum or the fixing bracket (Art.025-1265-000)



**025-1264-000**

**Art. 025-1264-000**

**Threaded ring M 2" Ø 50 mm for pumps fastening**

With locking wrench  
It connects to either the original drum or the fixing bracket (Art.025-1265-000)



**025-1265-000**

**Art. 025-1265-000**

**Painted steel wall fixing bracket**

Central ring nut F 2 "G  
For wall fixing pump Mod.500-600-800



**025-1265-010**

**Art. 025-1265-010**

**Painted steel wall fixing bracket**

With anti-vibration rubber spacers  
For wall fixing industrial pump flanged and break



**025-1267-000**

**Art. 025-1267-000**

**IBC tank - fixing bracket**

Central ring nut F 2 "G  
for fixing pump-hose reel



**025-1267-B00**

**Art. 025-1267-B00**

**IBC tank - fixing bracket kit**

To collect drops on the tank (024-1785-000)

**Art. 025-1270-094**

**Suction kit for wall-fixing pumps**

Composed by:

Art.025-1268-094 Ø 42 mm suction tube 940 mm length

Art.025-1262-000 Threaded ring for pumps fastening M2" Ø 42 mm

Art.910-0600-020 Flex. hose Ø 25 2,0 m length

Art.B27-1132-035 N.2 stainless steel screw clamps 32-35 mm



**025-1270-094**

**Art. 025-1270-125**

**Suction kit for wall-fixing pumps**

Composed by:

Art.025-1268-125 Ø 42 mm suction tube 1250 mm length

Art.025-1262-000 Threaded ring for pumps fastening M2" Ø 42 mm

Art.910-0600-020 Flex. hose Ø 25 2,0 m length

Art.B27-1132-035 N.2 stainless steel screw clamps 32-35 mm

**Art. 025-1271-094**

**STAINLESS STEEL suction kit for wall-fixing pumps**

Composed by:

Art.025-1269-094 Ø 42 mm STAINLESS STEEL suction tube 940 mm l

Art.025-1262-000 Threaded ring for pumps fastening M 2" Ø 42 mm

Art.911-0600-020 Flex. blue hose Ø 25 2,0 m length

Art.B27-1132-035 N.2 stainless steel screw clamps 32-35 mm



**025-1271-094**

**Art. 025-1271-125**

**STAINLESS STEEL suction kit for wall-fixing pumps**

Composed by:

Art.025-1269-125 Ø 42 mm STAINLESS STEEL suction tube 1250 mm l

Art.025-1262-000 Threaded ring for pumps fastening M 2" Ø 42 mm

Art.911-0600-020 Flex. blue hose Ø 25 2,0 m length

Art.B27-1132-035 N.2 stainless steel screw clamps 32-35 mm

**Art. 025-1285-094**

**Suction kit for wall-fixing industrial pumps**

Composed by:

Art.025-1280-094 Ø 50 mm suction tube 940 mm length

Art.025-1264-000 Threaded ring for pumps fastening M2" Ø 50 mm

Art.906-0738-020 1SC 1.1/4" hose F1.1/2"- F90° 1.1/2" 2,0 m length



**025-1285-094**

**Art. 025-1285-125**

**Suction kit for wall-fixing industrial pumps**

Composed by:

Art.025-1280-125 Ø 50 mm suction tube 1250 mm length

Art.025-1264-000 Threaded ring for pumps fastening M2" Ø 50 mm

Art.906-0738-020 1SC 1.1/4" hose F1.1/2"- F90° 1.1/2" 2,0 m length



025-1272-000



025-1274-000

**Art. 025-1272-000**

Connection 1" G - M40X1,25

It connects the pump to the modular extensions

**Art. 025-1274-000**

Connection M 40X1,25

Allows the connection between the modular extensions

**Art. 025-1275-025**

Ø 42 mm 250 mm length extension

Thread F-F M 40X1,25

**Art. 025-1275-050**

Ø 42 mm 500 mm length extension

Thread F-F M 40X1,25

**Art. 025-1275-092**

Ø 42 mm 912 mm length extension

Thread F-F M 40X1,25

**Art. 025-1275-122**

Ø 42 mm 1212 mm length extension

Thread F-F M 40X1,25

**Art. 025-1276-000**

Oil shank end with filter Ø 42 mm

Thread M 40X1,25

025-1276-000



025-1275-025



025-1275-050



025-1275-092



025-1275-122



R18-1210-006



R18-1211-006

**Brass 90° connection**

Article	Inlet-Outlet	Max pressure	Metal	Weight
R18-1210-006	M1" - F1"	100 bar	Brass	0,150 kg
R18-1211-006	F1" - F1"	100 bar	Brass	0,170 kg



R18-1250-006



R18-1251-006

**Stainless steel 90° connection**

Article	Inlet-Outlet	Max pressure	Metal	Weight
R18-1250-006	M1" - F1"	100 bar	SS AISI 316	0,137 kg
R18-1251-006	F1" - F1"	100 bar	SS AISI 316	0,158 kg

**Stainless steel connection fixed rubber hose**

Article	Inlet	Ø hose	Metal	Weight
R18-0821-256	M1"	25 mm	SS AISI 316	0,137 kg

**Connection fixed rubber hose**

Article	Inlet	Ø hose	Metal	Weight
R18-0855-255	M3/4"	25 mm	Brass	0,084 kg
R18-0855-206	M1"	20 mm	Brass	0,095 kg
R18-0855-256	M1"	25 mm	Brass	0,126 kg

**Galvanized steel connection fixed rubber hose**

Article	Inlet	Ø hose	Metal	Weight
R18-0803-206	M1"	20 mm	Galvanized steel	0,095 kg
R18-0803-256	M1"	25 mm	Galvanized steel	0,105 kg



R18-0855-256



R18-0821-256



R18-0803-206



R18-0803-256

## Y-shaped nickel-plated brass in-line filter

Article	Inlet-Outlet	Max pressure	Filter	Weight
R34-0002-004	F1/2"- F1/2"	100 bar	400 µm	0,160 kg
R34-0002-005	F3/4"- F3/4"	100 bar	400 µm	0,220 kg
R34-0002-006	F1"- F1"	100 bar	400 µm	0,330 kg



R34-0002-006

## 2-ways ball valves with full bore lever

Article	Inlet-Outlet	Max pressure	Max delivery	Weight
R30-0400-004	F1/2"-F1/2"	70 bar	80 l/min	0,20 kg
R30-0400-005	F3/4"-F3/4"	50 bar	120 l/min	0,31 kg
R30-0400-006	F1"-F1"	50 bar	160 l/min	0,43 kg



R30-0400-004

## Control valve overpressure system

Article	Inlet-Outlet	Min-Max calibration	Max delivery	Weight
F96-0900-424	F1/2"-F1/2"	5-50 bar	80 l/min	0,50 kg
F96-0900-525	F3/4"-F3/4"	5-50 bar	120 l/min	0,80 kg
F96-0900-626	F1"-F1"	5-50 bar	150 l/min	2,76 kg



F96-0900-525

## 4-ways evacuation valve

Article	Inlet-Outlet	Max pressure	Seals	Weight
F96-0800-006	F1"-F1"	14 bar-200 psi	viton®	3,900 kg

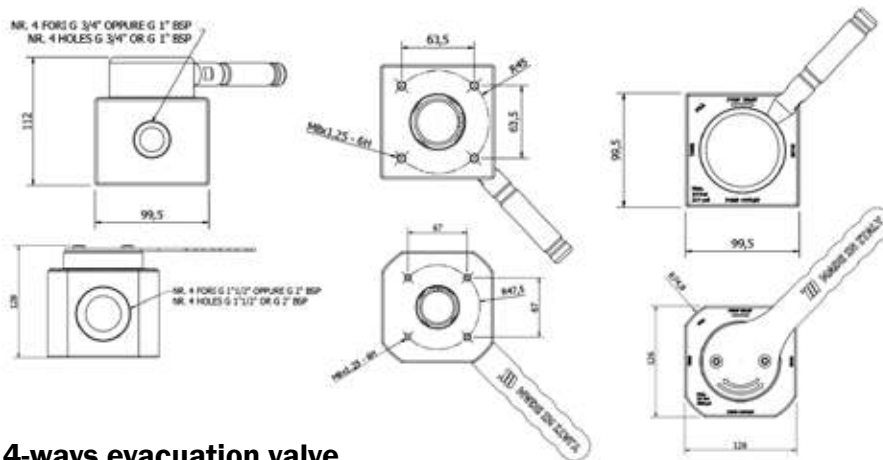

F96-0800-006

## 4-ways evacuation valve

Article	Inlet-Outlet	Max pressure	Seals	Weight
F96-0800-009	F2"-F2"	14 bar-200 psi	viton®	5,500 kg

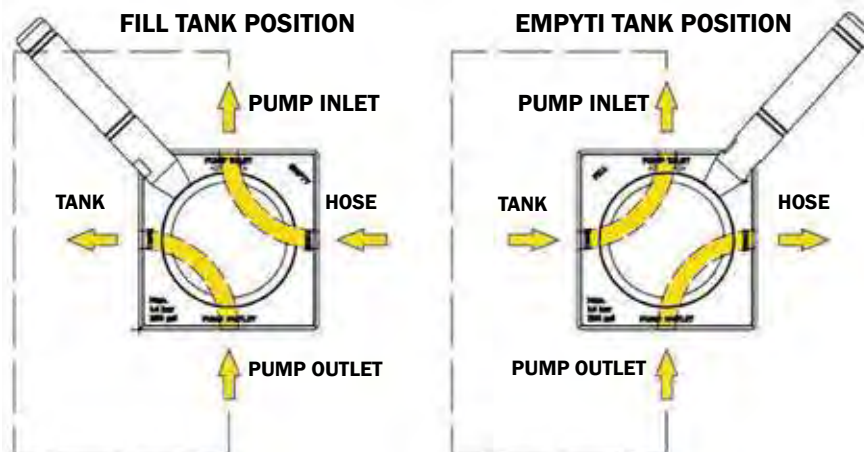

F96-0800-009

4 ways evacuation valve with anodized steel body and connections F 3/4"- F 1" - F 1 1/2" - F 2" BSP. It is mainly used for the discharge and the suction of exhausted oils like hydraulic oil, gear oil, engine oil, etc.

## BSP male - BSP male nipples



Article	Threaded
F96-0100-202	M1/4" BSP - M1/4" BSP
F96-0100-303	M3/8" BSP - M3/8" BSP
F96-0100-404	M1/2" BSP - M1/2" BSP
F96-0100-505	M3/4" BSP - M3/4" BSP
F96-0100-606	M1" BSP - M1" BSP
F96-0100-707	M1.1/4" BSP - M1.1/4" BSP
F96-0100-808	M1.1/2" BSP - M1.1/2" BSP
F96-0100-909	M2" BSP - M2" BSP

## BSP male - NPTF male nipples



Article	Threaded
F96-0110-202	M1/4" BSP - M1/4" NPTF
F96-0110-303	M3/8" BSP - M3/8" NPTF
F96-0110-404	M1/2" BSP - M1/2" NPTF
F96-0110-505	M3/4" BSP - M3/4" NPTF
F96-0110-606	M1" BSP - M1" NPTF
F96-0110-707	M1.1/4" BSP - M1.1/4" NPTF
F96-0110-808	M1.1/2" BSP - M1.1/2" NPTF
F96-0110-909	M2" BSP - M2" NPTF

## BSP male - BSP male reduced nipples



Article	Threaded
F96-0100-302	M3/8" BSP - M1/4" BSP
F96-0100-402	M1/2" BSP - M1/4" BSP
F96-0100-403	M1/2" BSP - M3/8" BSP
F96-0100-504	M3/4" BSP - M1/2" BSP
F96-0100-604	M1" BSP - M1/2" BSP
F96-0100-605	M1" BSP - M3/4" BSP
F96-0100-806	M1.1/2" BSP - M1" BSP
F96-0100-807	M1.1/2" BSP - M1.1/4" BSP
F96-0100-907	M2" BSP - M1.1/4" BSP
F96-0100-908	M2" BSP - M1.1/2" BSP

## BSP male - NPTF male reduced nipples



Article	Threaded
F96-0110-204	M1/4" BSP - M1/2" NPTF
F96-0110-302	M3/8" BSP - M1/4" NPTF
F96-0110-304	M3/8" BSP - M1/2" NPTF
F96-0110-305	M3/8" BSP - M3/4" NPTF
F96-0110-403	M1/2" BSP - M3/8" NPTF
F96-0110-405	M1/2" BSP - M3/4" NPTF
F96-0110-504	M3/4" BSP - M1/2" NPTF
F96-0110-604	M1" BSP - M1/2" NPTF
F96-0110-605	M1" BSP - M3/4" NPTF
F96-0110-806	M1.1/2" BSP - M1" NPTF
F96-0110-807	M1.1/2" BSP - M1.1/4" NPTF
F96-0110-907	M2" BSP - M1.1/4" NPTF
F96-0110-908	M2" BSP - M1.1/2" NPTF

## BSP male - BSP female extension



Article	Threaded
F96-0210-404	M1/2" BSP - F1/2" BSP
F96-0210-505	M3/4" BSP - F3/4" BSP

## NPTF male - BSP female extension

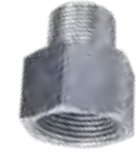

Article	Threaded
F96-0212-404	M1/2" NPTF - F1/2" BSP
F96-0212-505	M3/4" NPTF - F3/4" BSP

## BSP male - BSP female reduced extension



Article	Threaded
F96-0210-203	M1/4" BSP - F3/8" BSP
F96-0210-304	M3/8" BSP - F1/2" BSP
F96-0210-305	M3/8" BSP - F3/4" BSP
F96-0210-405	M1/2" BSP - F3/4" BSP
F96-0210-506	M3/4" BSP - F1" BSP

## NPTF male - BSP female reduced extension

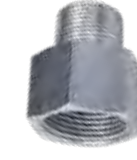

Article	Threaded
F96-0212-304	M3/8" NPTF - F1/2" BSP
F96-0212-305	M3/8" NPTF - F3/4" BSP
F96-0212-405	M1/2" NPTF - F3/4" BSP
F96-0212-506	M3/4" NPTF - F1" BSP

## BSP male - BSP female plug reductions



Article	Threaded
F96-0300-201	M1/4" BSP - F1/8" BSP
F96-0300-302	M3/8" BSP - F1/4" BSP
F96-0300-403	M1/2" BSP - F3/8" BSP
F96-0300-504	M3/4" BSP - F1/2" BSP
F96-0300-604	M1" BSP - F1/2" BSP
F96-0300-605	M1" BSP - F3/4" BSP
F96-0300-908	M2" BSP - F1.1/2" BSP

## NPTF male - BSP female plug reductions



Article	Threaded
F96-0302-403	M1/2" NPTF - F3/8" BSP
F96-0302-504	M3/4" NPTF - F1/2" BSP
F96-0302-605	M1" NPTF - F3/4" BSP

**Quick disconnect coupling female**

Article	Inlet	Pressure	Delivery	Iso
F96-0500-004	F 1/2"	250 bar	41 l/min	7241-A
F96-0500-005	F 3/4"	250 bar	81 l/min	7241-A
F96-0500-006	F 1"	230 bar	140 l/min	7241-A



F96-0500-004

**Quick disconnect coupling male**

Article	Inlet	Pressure	Delivery	Iso
F96-0502-004	F 1/2"	250 bar	41 l/min	7241-A
F96-0502-005	F 3/4"	250 bar	81 l/min	7241-A
F96-0502-006	F 1"	230 bar	140 l/min	7241-A



F96-0502-004

**Art. 025-1280-004**

**Flow control compensator F 1/2"**

It eliminates pressure changes ensuring a smooth flow

Composed by:

One-way check valve

Suitable for ratio pumps **R=1:1 - 3:1 - 5:1**

Max pressure 80 bar



025-1280-004

**Art. 910-0600-020**

**Flexible hose 1" Ø 25 mm 2 m length**

In black rubber spiralcarbur 10 bar sleeve

For wall-fixing pumps



910-0600-020

**Art. 911-0600-020**

**Flexible hose 1" Ø 25 mm 2 m length**

In blue rubber spiral 10 bar sleeve

For wall-fixing pumps with STAINLESS STEEL shank



911-0600-020

**Art. 906-0738-020**

**Flexible hose 1SC 1.1/4" F1.1/2" F 90° 1.1/2" 2,0 m length**

In black rubber 88 bar Ø 41 connected

For wall-fixing pumps



906-0738-020

**Connection flexible hoses**

Article	Characteristics	Pressure	Burst	Length
906-0424-015	1SC 1/2" F - F	W.P.160 bar	640 bar	1,5 m
906-0424-020	1SC 1/2" F - F	W.P.160 bar	640 bar	2,0 m
906-0404-030	1SC 1/2" M - F	W.P.160 bar	640 bar	3,0 m
906-0404-040	1SC 1/2" M - F	W.P.160 bar	640 bar	4,0 m
906-0404-050	1SC 1/2" M - F	W.P.160 bar	640 bar	5,0 m
906-0404-060	1SC 1/2" M - F	W.P.160 bar	640 bar	6,0 m
906-0404-075	1SC 1/2" M - F	W.P.160 bar	640 bar	7,5 m
906-0404-080	1SC 1/2" M - F	W.P.160 bar	640 bar	8,0 m
906-0404-100	1SC 1/2" M - F	W.P.160 bar	640 bar	10,0 m
906-0525-010	1SC 3/4" F - F	W.P.105 bar	420 bar	1,0 m
906-0525-015	1SC 3/4" F - F	W.P.105 bar	420 bar	1,5 m
906-0525-020	1SC 3/4" F - F	W.P.105 bar	420 bar	2,0 m
906-0505-030	1SC 3/4" M - F	W.P.105 bar	420 bar	3,0 m
906-0505-040	1SC 3/4" M - F	W.P.105 bar	420 bar	4,0 m
906-0505-050	1SC 3/4" M - F	W.P.105 bar	420 bar	5,0 m
906-0626-010	1SC 1" F - F	W.P.88 bar	352 bar	1,0 m
906-0626-020	1SC 1" F - F	W.P.88 bar	352 bar	2,0 m
906-0606-030	1SC 1" M - F	W.P.88 bar	352 bar	3,0 m



The FMS Compact is a compact and easy to use fluid management system for up to 4 dispense points (tank management). The system is equipped with an integral printer, alphanumeric keypad and internal large graphic display.

Due to its intelligent control, the system only allows operations by entering a personal code (up to 99 authorized operators). It prints a ticket after each transaction and stores up to 1600 transactions in its memory for eventual download to a PC computer. All the inputs and outputs of the system are wired by means of terminal clamps located inside the enclosure ensuring an easy “plug & play” installation without the need of opening the housing. The rugged steel housing and high quality plug connectors guarantee reliable operations in harsh conditions. Customised version with firmware adaption, LCR pulse scalars or internal pulse isolators are available upon request.

The FMS Compact can be used as a batch control and tank management system. It can be combined and managed with many mechanical and electronic flow meters via the pulse output/input offering a broad range of applications – from the management of mineral oils and similar fluids.



# CENTRALIZED FLUIDS MANAGING SYSTEMS FOR 4 DISPENSING POINTS "FMS Compact"

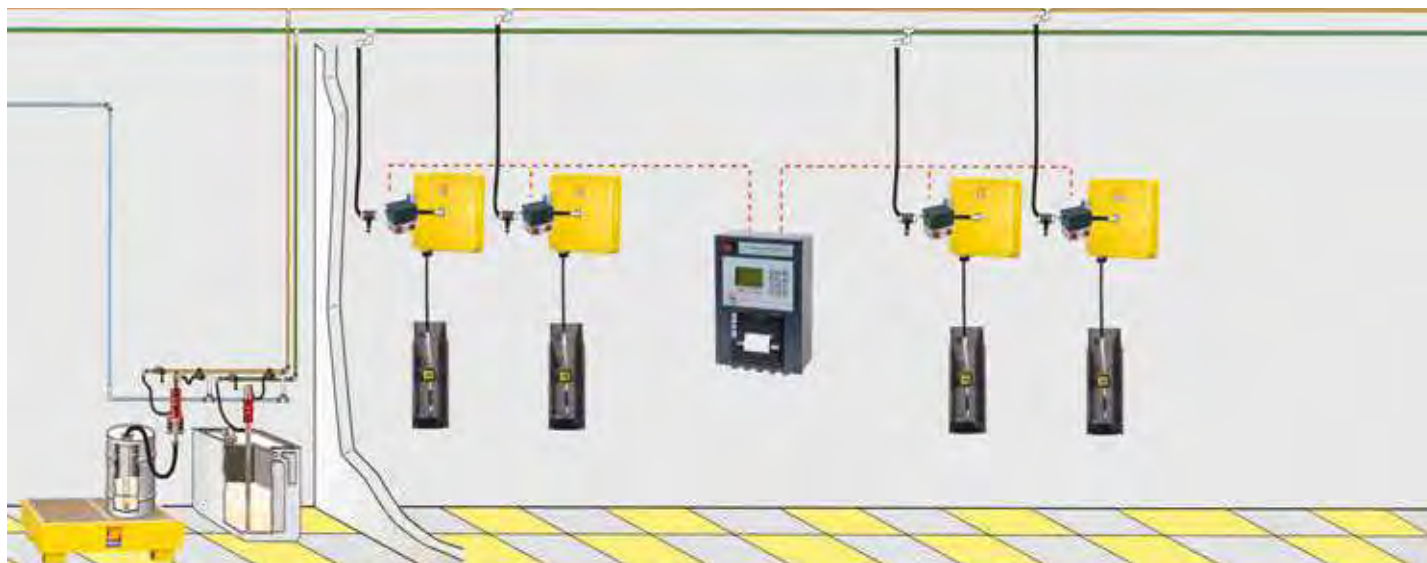

## Art. 026-1950-000

### FMS Compact control unit

To manage fluids up to 4 dispensing points with 4 different products  
Integrated printer for receipts  
Alphanumeric keypad  
RS 232 serial port for PC or printers  
Connection for barcode reader is available  
Protection class IP 42



026-1950-000

### Brass solenoid valve 24V DC 8W for oil and similar fluids

Article	Inlet-Outlet	Flow max	Pressure min-max	Viscosity max
026-1960-004	F 1/2"	60 l/min	0.15 - 25 bar	25 cST



026-1960-004

### Stainless steel AISI 316L solenoid valve 24V DC 8W for anti-freeze and windscreen

Article	Inlet-Outlet	Flow max	Pressure min-max	Viscosity max
026-1965-004	F 1/2"	60 l/min	0.15 - 25 bar	25 cST



026-1965-004

### Pulse transmitters for oil and similar fluids

Article	Inlet-Outlet	Flow min-max	Pressure min-max	Pulses/liter
026-1970-004	F 1/2"	1-35 l/min	0.35 - 100 bar	100



026-1970-004

### Pulse transmitters for anti-freeze and windscreen

Article	Inlet-Outlet	Flow min-max	Pressure min-max	Pulses/liter
026-1975-004	F 1/2"	1-35 l/min	0.35 - 100 bar	100



026-1975-004

Article	Inlet-Outlet	Flow min-max	Pressure min-max	Temperature	Accuracy	Pulses/liter
026-1970-004	F 1/2" BSP	1 - 35 l/min	0.35 - 100 bar	-10° + 50° C	+/- 0,5%	100
026-1975-004	F 1/2" BSP	1 - 35 l/min	0.35 - 100 bar	-10° + 60° C	+/- 0,5%	100

The oil management system MDS 2000 has been designed to control and manage lubricants to achieve product accountability and profit centre protection. The system is especially designed to be installed in small or large garages, car pools, forwarders and industry.

The entry level consists of one alphanumeric access keypad, network linked to one I/O control unit, controlling up to 8 dispensing points each of which with the same fluid/grade.

Transaction data is retrieved on a standard serial printer. The system upgrades easily to control up to 64 dispensing points, all working simultaneously with multi-access keypads.

Transaction tickets printers can be connected on each keypad to hold the mechanic accountable and/or to print the data at different workshop departments. The data can be archived, restored and exported to the main workshop computer. The system can communicate with any workshop host computer by means of a free programmable RS 232 interface.

- CAN-Bus technology
- Compatible with asanet
- Connection to garage software
- Protection class IP 42
- PTB approved

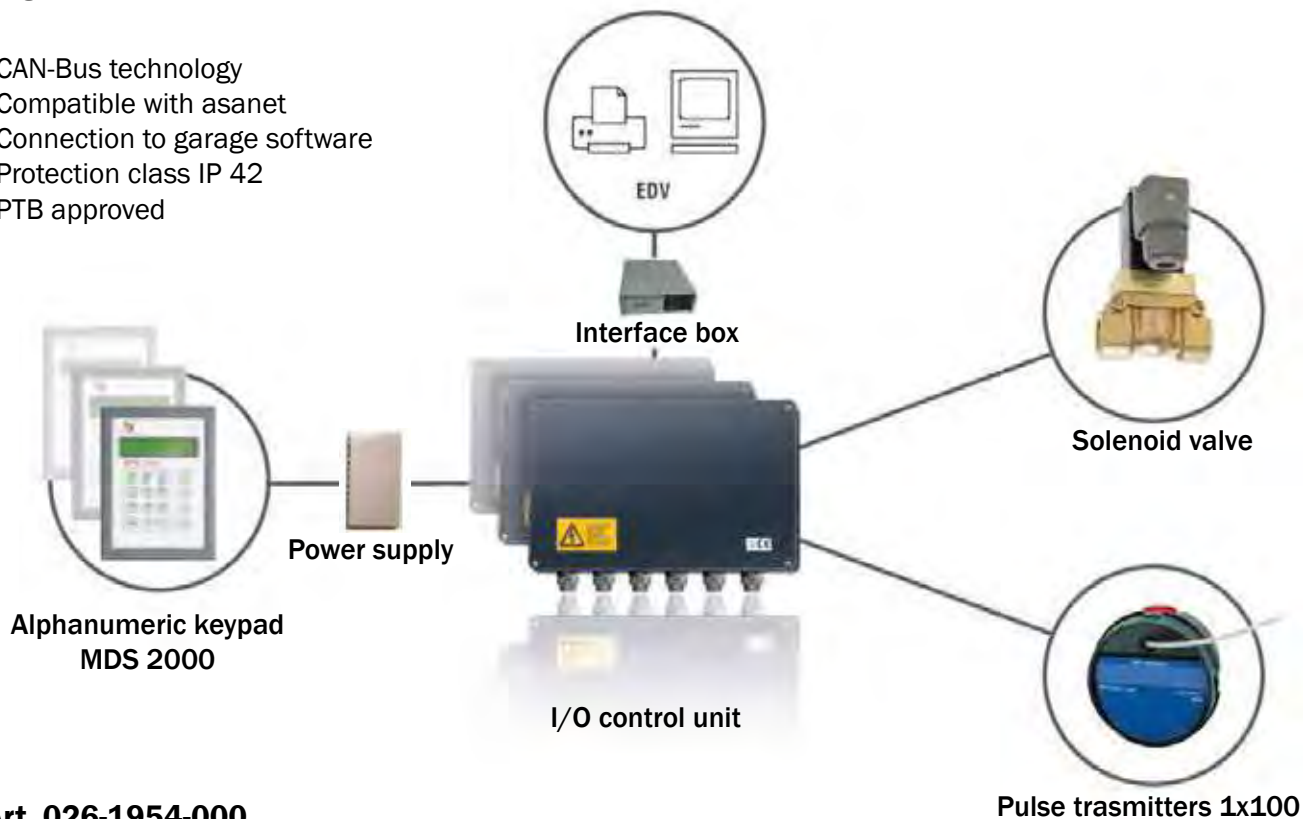

**Art. 026-1954-000**

**Alphanumeric keypad MDS 2000**

Designed to control and monitoring oils and other fluids enabling a dispense with a +/- 0.5% tolerance.

It is possible to serially connect 8 control units to manage up to 64 dispensing points.

**Art. 026-1955-000**

**I/O power supply I/O for MDS 2000**

Inlet : 230 VAC, 6.3A, 360 VA

Output: power supply I/O 1-2

**Art. 026-1956-000**

**Box -7 interface for MDS 2000**

with RS 232 CAN-BUS connection

**Art. 026-1958-000**

**I/O control unit**

It is the core of the MDS system and it manages all the operations.



**026-1954-000**



**026-1955-000**



**026-1958-000**

**Brass solenoid valve 24V DC 8W**  
for oil and similar fluids

Article	Inlet-Outlet	Flow max	Pressure min-max	Viscosity max
026-1960-004	F 1/2"	60 l/min	0.15 - 25 bar	25 cST
026-1960-005	F 3/4"	90 l/min	0.15 - 25 bar	25 cST



026-1960-004

**Stainless steel AISI 316L solenoid valve 24V DC 8W**  
for anti-freeze and windscreen

Article	Inlet-Outlet	Flow max	Pressure min-max	Viscosity max
026-1965-004	F 1/2"	60 l/min	0.15 - 25 bar	25 cST
026-1965-005	F 3/4"	90 l/min	0.15 - 25 bar	25 cST



026-1965-004

**Pulse trasmitters**  
for oil and similar fluids

Article	Inlet-Outlet	Flow min-max	Pressure min-max	Pulses/liter
026-1970-004	F 1/2"	1-35 l/min	0.35 - 100 bar	100
026-1970-005	F 3/4"	3-60 l/min	0.35 - 100 bar	66,75



026-1970-004

**Pulse trasmitters**  
for anti-freeze and windscreen

Article	Inlet-Outlet	Flow min-max	Pressure min-max	Pulses/liter
026-1975-004	F 1/2"	1-35 l/min	0.35 - 100 bar	100
026-1975-005	F 3/4"	3-60 l/min	0.35 - 100 bar	66,75



026-1975-004

**Pulse trasmitters “MID approved”**  
for oil and similar fluids

Article	Inlet-Outlet	Flow min-max	Pressure min-max	Pulses/liter
026-1971-MID	F 1/2"	1-35 l/min	0.35 - 100 bar	100



026-1971-MID

**Pulse trasmitters “MID approved”**  
for anti-freeze

Article	Inlet-Outlet	Flow min-max	Pressure min-max	Pulses/liter
026-1976-MID	F 1/2"	1-35 l/min	0.35 - 100 bar	100



026-1976-MID

Article	Inlet-Outlet	Fluids	Flow min-max	Pressure	Temperature	Accuracy	Pulses/liter
026-1970-004	F 1/2" BSP	oil	1 - 35 l/min	0.35 - 100 bar	-10° + 50° C	+/- 0,5%	100
026-1970-005	F 3/4" BSP	oil	3 - 60 l/min	0.35 - 100 bar	-10° + 60° C	+/- 0,75%	66,75
026-1975-004	F 1/2" BSP	anti-freeze windscreen	1 - 35 l/min	0.35 - 100 bar	-10° + 50° C	+/- 0,5%	100
026-1975-005	F 3/4" BSP	anti-freeze windscreen	3 - 60 l/min	0.35 - 100 bar	-10° + 60° C	+/- 0,75%	66,75
026-1971-MID	F 1/2" BSP	oil	1 - 10 l/min	0.35 - 100 bar	-10° + 50° C	+/- 0,3%	100
026-1976-MID	F 1/2" BSP	anti-freeze	1 - 10 l/min	0.35 - 100 bar	-10° + 50° C	+/- 0,3%	100

## FLUID MANAGEMENT SYSTEMS

Oil management systems that dispense volumes of fluids in automotive workshops require highly accurate flow meters and pulse transmitters, trouble-free and secured manipulation in remote transmission equipment in addition to durable data memory that is able to retrieve dispense data, quantities and oil products at any time. The radio frequency based systems with MID approval offer the advantage of a wireless communication between the dispensing terminal and meter.

## LMS-RFZ SYSTEM

### WIRELESS OIL MANAGEMENT SYSTEMS WITH ZigBee® TECHNOLOGY

The LMS-RFZ oil management system offers wireless communication between all terminals and meters using the ZigBee® radio technology.

All terminals are creating a dynamic meshed radio network in the workshop which optimizes the radio coverage and also enables the bridging of long distances. Mobile trolleys can be easily connected. The system can be connected to a local Dealer Management System (DMS) by using a free programmable HOST Interface.

## LMS-RFZ BASIC SYSTEM (2.5 GHz)

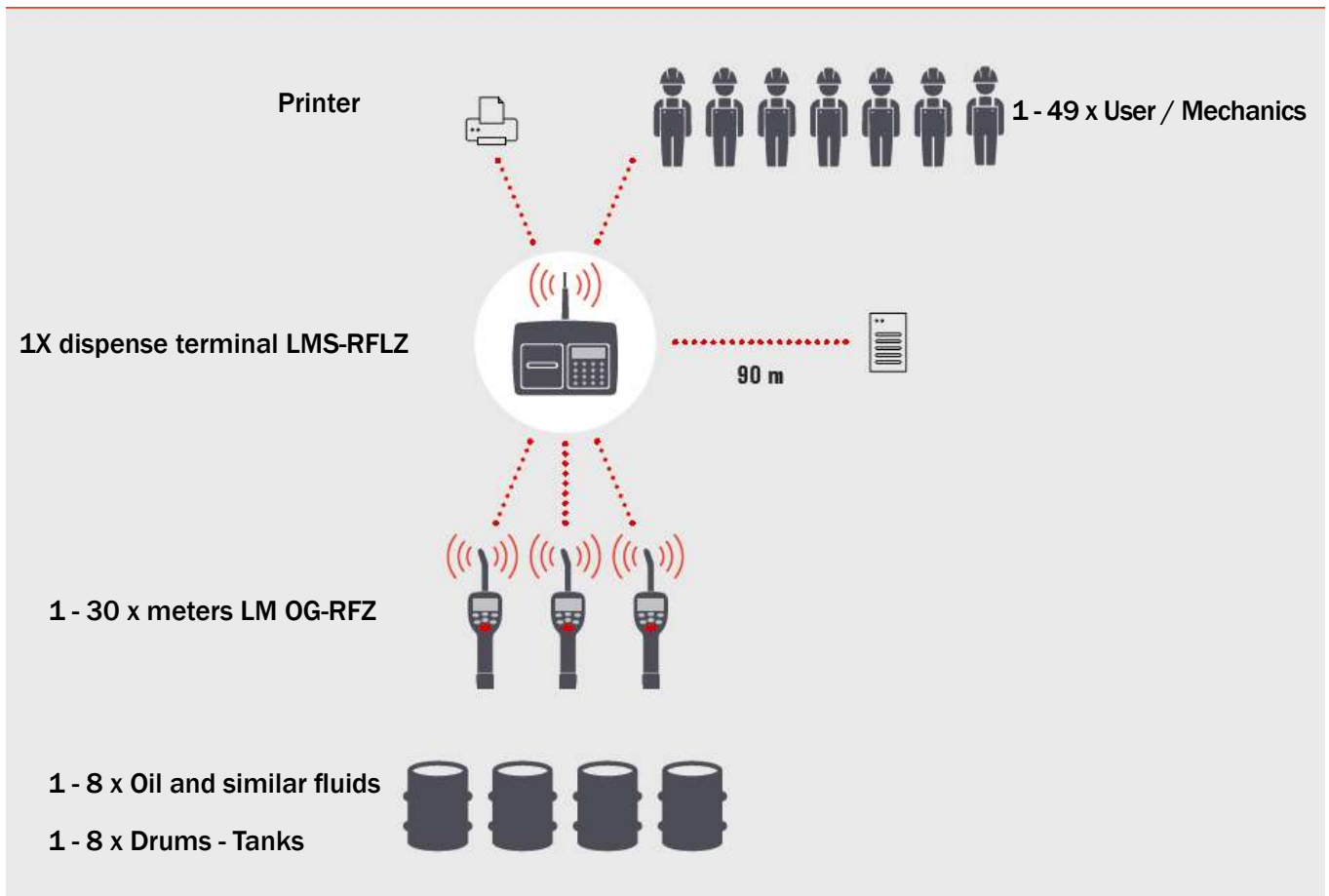

- **BASIC system**

- Up to 49 possible users/mechanics

- Integration of barcode scanners possible.

- Quick installation, no cutting into existing pipes
- ZigBee® technology 2,4 GHz
- Encrypted RF communication
- Easy upgrades

# "BASIC" WIRELESS FLUIDS MANAGING SYSTEM WITH ZigBee TECHNOLOGY RADIOFREQUENCY NETWORK



## Art. 026-2010-000

### Wireless Terminal Dispense-Basic LMS-RFLZ

Composed by:  
12 buttons keypad  
LCD display  
Integrated printer



026-2010-000

## Art. 026-2015-A00

### LM OG-RFZ radiofrequency digital meter

For oil and similar fluids, Composed by:  
Digital flow meter with preselection  
Handle with swivelling joint F 1/2" BSP  
Flexible end 105° Manual drop valve Ø 12 mm



026-2015-A00

## Art. 026-2015-C00

### LM OG-RFZ radiofrequency digital meter

For oil and similar fluids, Composed by:  
Digital flow meter with preselection  
Handle with swivelling joint F 1/2" BSP  
Flexible end 105° Automatic drop valve Ø 14 mm



026-2015-C00

## Art. 026-2015-D00

### LM OG-RFZ radiofrequency digital meter

For oil and similar fluids, Composed by:  
Digital flow meter with preselection  
Handle with swivelling joint F 1/2" BSP  
Rigid end 45° Automatic drop valve Ø 14 mm



026-2015-D00

## Art. 026-2015-DX0

### LM OG-RFZ radiofrequency digital meter

For anti-freeze and windscreen, Composed by:  
Digital flow meter with preselection  
Handle with swivelling joint F 1/2" BSP  
Rigid end 45° stainless steel, automatic anti-drop valve Ø 13,5mm



026-2015-DX0

Article	Inlet-Outlet	Fluids	Flow min max	Pressure min-max	Temperature	Accuracy	Battery powered
026-2015-A00	F 1/2" BSP	oil	1 - 30 l/min	0.35 - 70 bar	-5° + 50° C	+/- 0,5%	4 x 1,5V AA
026-2015-C00	F 1/2" BSP	oil	1 - 30 l/min	0.35 - 70 bar	-5° + 50° C	+/- 0,5%	4 x 1,5V AA
026-2015-D00	F 1/2" BSP	oil	1 - 30 l/min	0.35 - 70 bar	-5° + 50° C	+/- 0,5%	4 x 1,5V AA
026-2015-DX0	F 1/2" BSP	anti-freeze windscreen	1 - 30 l/min	0.35 - 70 bar	-5° + 50° C	+/- 0,5%	4 x 1,5V AA

## BASIC SYSTEM

The RF oil management system is designed to control and monitor the consumption and inventory balances of automotive fluid products with minimal installation and programming costs. The system is using RF communication between the keypad and the meter. The wall mounted keypad module consists of a 12-button keypad, LCD display and integral ticket printer. The system can control up to 30 meters and track 8 different fluids and tanks, sending and receiving data typically up to 90m (300 feet) in a service facility installation. A unique, patented feature of the control system is that the trigger of the dispensing meter is locked until authorization from the keypad is received. After the dispense is completed, the user can top off the dispense and the actual amount used is sent back to the keypad. The meter then returns to the locked status. Additionally, the meter can be installed on portable dolly systems offering control and monitoring of often high-cost lubrication products.

## HIGH END SYSTEM

The HIGH END system hardware consists of one master keypad and at least one dispense keypad as well as at least one radio frequency (RF) electronic prekit meter. The master keypad handles serial communication between the PC or a host server (ERP system) and RF communication to the dispense keypads in the system. The system verifies the operator’s pin number and validates the work order number, fluid quantities and the valid hose/meter.

The master keypad can communicate with up to 36 dispense keypads that can be positioned to support the workflow of the facility the best way. Each dispense keypad can control up to 24 meters, for a total of 250 meters. The system supports up to 16 tanks and 16 fluids as a part of the system configuration. The system supports 250 unique operator IDs and pin numbers. The system uses direct sequence spread spectrum RF technology to prevent communication problems with other equipment in the facility. The RF system will look for a clear channel for transmission to insure that there is reliable communications at all times.

Communication distances are typically up to 100 meters, but can go up to 300 meters with unobstructed line-of-sight. A remote antenna is available for situations where multiple buildings are involved in the installation.

## HIGH END System

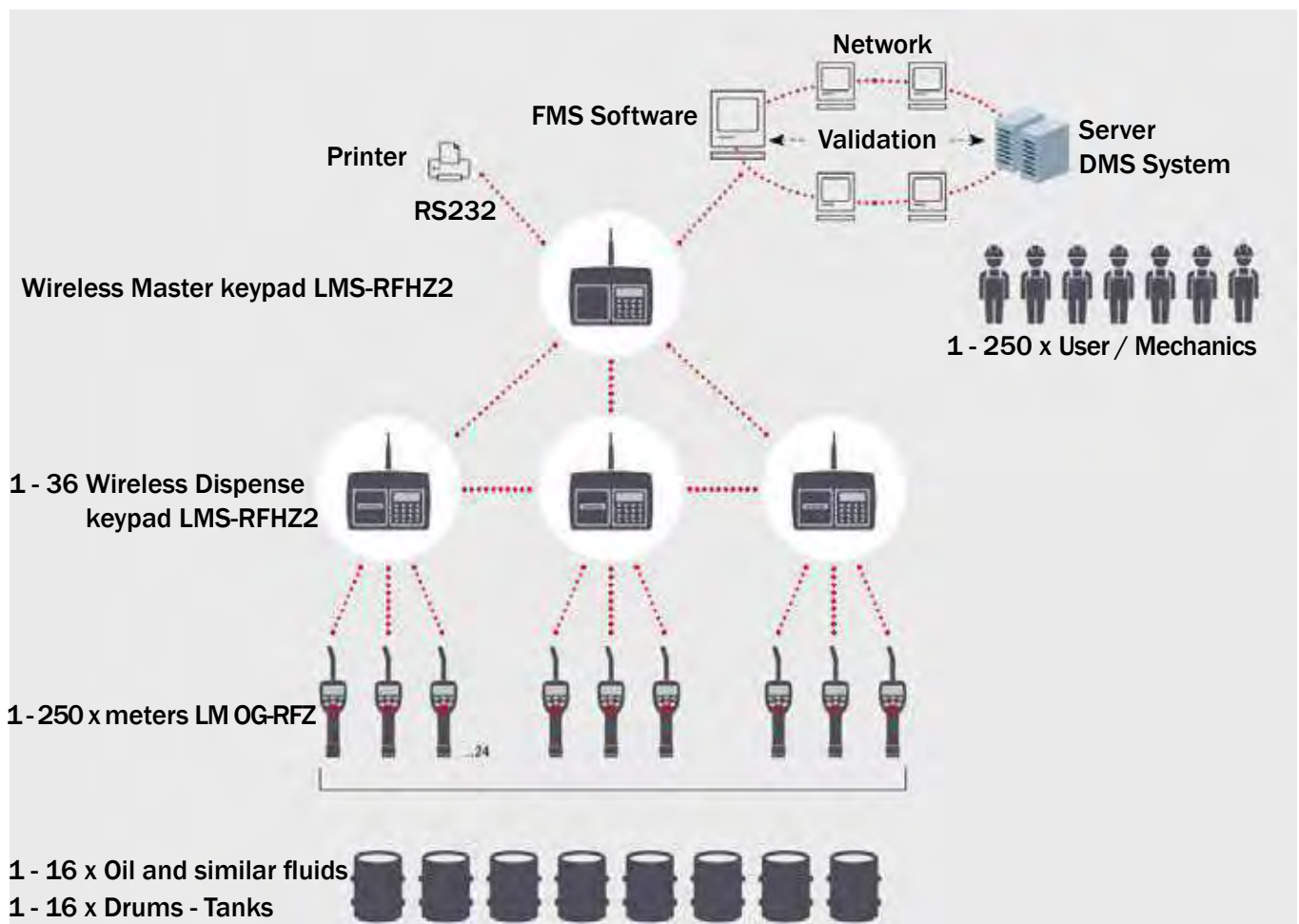

- Up to 250 possible users/mechanics
- It is possible the connection to the interfaces for the garage equipment (ASA-Network, Autoline, Vaudis, Alphaplus, Cross and many more)
- Integration of barcode scanners possible
- Quick installation, no cutting into existing pipes
- ZigBee® technology 2,4 GHz
- Encrypted RF communication
- Easy upgrades
- Includes PC software package (High End System)

**Art. 026-2012-000**

**Wireless Master keypad LMS-RFHZ2**

Composed by:  
Keypad with 12 buttons  
LCD display  
Integrated printer  
RS232 connection to printer  
RS232 connection to local ERP or DMS System  
FMS software for administration and data collection



026-2012-000

**Art. 026-2013-000**

**Wireless Dispense keypad LMS-RFHZ2**

Composed by:  
Keypad with 12 buttons  
LCD display

**Art. 026-2014-000**

**Wireless Dispense keypad LMS-RFHZ2-PRT**

Like 026-2013-000 but with integrated printer  
Integrated printer



026-2013-000

**Art. 026-2015-C00**

**Radiofrequency digital meter LM OG-RFZ**

For oil and similar, Composed by:  
Digital flow meter with preselection  
Handle with swivelling joint F 1/2” BSP  
Flexible end 105° automatic anti-drop valve Ø 12mm

**Art. 026-2015-A00**

**Radiofrequency digital meter LM OG-RFZ**

Composed like Art.026-2015-C00 but with:  
Flexible end 105° manual drop valve Ø 14mm



026-2015-C00

**Art. 026-2015-D00**

**Radiofrequency digital meter LM OG-RFZ**

For oil and similar, Composed by:  
Digital flow meter with preselection  
Handle with swivelling joint F 1/2” BSP  
Rigid end 45° automatic anti-drop valve Ø 14mm



026-2015-D00

**Art. 026-2015-DX0**

**Radiofrequency digital meter LM OG-RFZ**

For anti-freeze and windscreen, Composed by:  
Digital flow meter with preselection  
Handle with swivelling joint F 1/2” BSP  
Rigid end 45° stainless steel, automatic anti-drop valve Ø 13,5mm



026-2015-DX0

Article	Inlet-Outlet	Fluids	Flow min max	Pressure min-max	Temperature	Accuracy	Battery powered
026-2015-A00	F 1/2” BSP	oil	1 - 30 l/min	0.35 - 70 bar	-5° + 50° C	+/- 0,5%	4 x 1,5V AA
026-2015-C00	F 1/2” BSP	oil	1 - 30 l/min	0.35 - 70 bar	-5° + 50° C	+/- 0,5%	4 x 1,5V AA
026-2015-D00	F 1/2” BSP	oil	1 - 30 l/min	0.35 - 70 bar	-5° + 50° C	+/- 0,5%	4 x 1,5V AA
026-2015-DX0	F 1/2” BSP	anti-freeze windscreen	1 - 30 l/min	0.35 - 70 bar	-5° + 50° C	+/- 0,5%	4 x 1,5V AA



**026-2040-000**

**Art. 026-2040-000**

**DMS software interface**

Interface for management system



**026-2030-004**

**Art. 026-2030-004**

**TANK SURVEILLANCE SmartBox 4 LAN**

The fluid management system can be connected to a LAN based tank surveillance system SmartBox® 4 LAN.

It can be used for remote monitoring of the level in unpressurized tanks containing liquids. In addition to recording the tank content and remote data transfer, other functions can be implemented by system enhancements. It has a 2-line LCD display, four measuring inputs to connect the probes, a fault message input and an integrated network connection for remote data transmission.

- Four probes can be attached to one SmartBox® LAN PRO
- Additional units can be added to cover 16 tanks
- Additional administration software available
- The FMS software can send a tank level warning by e-mail to various recipients
- The level in movable trollies can still be calculated by consumption



**026-2035-000**

**Art. 026-2035-000**

**Detection sensor for SmartBox 4 LAN**

To control the liquids' level in the tanks

## Art. 026-1900-000

Electronic level indicator MEC 200 for drums 180-208 l

Unit of measurement: litres

Don't use the device with flammable liquids

## Art. 026-1900-G00

Electronic level indicator MEC 200 for drums 48-55 gal

Unit of measurement: gallons

Don't use the device with flammable liquids

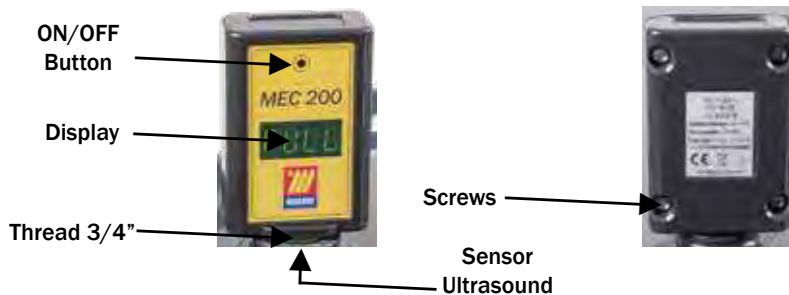

## DESCRIPTION

MEC 200 is an ultrasound electronic device that detects the distance with a liquid or a solid, converting it into volume through an algorithm. With the calibration level kit up by the manufacturer, MEC 200 calculates the level of the liquid inside the 180/208 l drums.

## MODE OF OPERATION

### SWITCHING ON/OFF

Press the button on the display for more than 3 seconds to switch the device on and off. If you are switching it on, "On" will appear on the display; if you are switching it off, "Off" will appear on the display.

### AUTOMATIC MEASUREMENT

Once you switch it on, it will measure the level every 20 minutes, without showing anything.

When it starts flashing with "ALL. 20 L.", it is informing the operator that the level of stock available in the drum is between 20 and 10 l. When this happens, the device keeps showing the alarm status until the button on/off is pressed, thereafter at every press of the button a single measurement will be displayed.

When it starts flashing with "ALL. 10 L.", it is informing the operator that the level of stock available in the drum is between 10 and 0 l. When this happens, the device will keep showing the alarm status until it will be switched off and/or the empty drum will be replaced by a new one.

### IMMEDIATE MEASUREMENT

If by pressing the on/off button you will see "FULL", it means that the drum contains more than 145 l. If the level is between 145 l and 20 l, by pressing the button you will see the actual litres contained in the drum. If the level is below 20 l the operator will see the different warnings seen in the previous paragraph.

### LOW BATTERY

When the batteries of the device are low, the device warns the operator. It is displayed with 4 points flashing every 5 seconds. In this status MEC 200 does not provide any measurement, you must switch the device off and change the batteries (2X1,5V AAA).

## WARNINGS

- Do not use the device on drums containing flammable liquids or releasing explosive gases;
- Do not put the device into direct contact with the contents of the drum;
- Do not use the device on drums placed on a sloping area;
- Do not move the drum when the device is installed.



**027-1305-000**

## Art. 027-1305-000

### 24 I pneumatic oil dispenser

Composed by:

Tank capacity 24 I (with level indicator)

Delivery hose Ø 12 mm spring PU hose 3 m length (027-1303-030)

Oil dispensing nozzle (024-1232-E00)

With flexible end manual drop valve Ø 12 mm

Funnel to fill the tank



027-1305-000 11,700 0,074 1

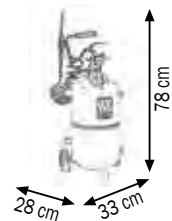

**027-1307-000**

## Art. 027-1307-000

### 24 I pneumatic oil dispenser stainless steel

Composed by:

Tank capacity 24 I (with level indicator)

Delivery hose Ø 12 mm spring PU hose 3 m length (027-1303-030)

Oil dispensing nozzle (024-1232-E00)

With flexible end manual drop valve Ø 12 mm

Funnel to fill the tank



027-1307-000 10,400 0,074 1

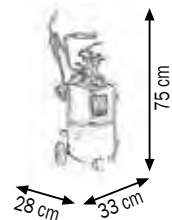

**027-1310-000**

## Art. 027-1310-000

### 50 I pneumatic oil dispenser

Composed by:

Tank capacity 50 I (with level indicator)

Delivery hose Ø 12 mm spring PU hose 3 m length (027-1303-030)

Oil dispensing nozzle (024-1232-E00)

With flexible end manual drop valve Ø 12 mm

Funnel to fill the tank



027-1310-000 23,100 0,152 1

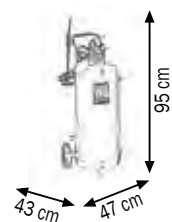

They are advised for the filling and maintenance of oil. The tank has to be filled for 4/5 of its capacity and when air is put inside at 6-8 bar it works automatically without any continuous connection to compressed air.

## Art. 027-1306-000

### 24 l pneumatic oil dispenser

Composed by:

Tank capacity 24 l (with level indicator)

Delivery hose Ø 12 mm spring PU hose 3 m length (027-1303-030)

**Oil digital nozzle** (Art.024-1233-A00)

With flexible end manual drop valve Ø 12 mm

Funnel to fill the tank



027-1306-000 12,900 0,074 1

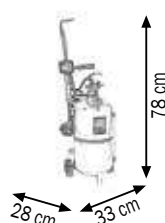

027-1306-000

## Art. 027-1308-000

### 24 l pneumatic oil dispenser stainless steel

Composed by:

Tank capacity 24 l (with level indicator)

Delivery hose Ø 12 mm spring PU hose 3 m length (027-1303-030)

**Oil digital nozzle** (Art.024-1233-A00)

With flexible end manual drop valve Ø 12 mm

Funnel to fill the tank



027-1308-000 11,600 0,074 1

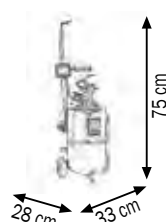

027-1308-000

## Art. 027-1312-000

### 50 l pneumatic oil dispenser

Composed by:

Tank capacity 50 l (with level indicator)

Delivery hose Ø 12 mm spring PU hose 3 m length (027-1303-030)

**Oil digital nozzle** (Art.024-1233-A00)

With flexible end manual drop valve Ø 12 mm

Funnel to fill the tank



027-1312-000 24,100 0,152 1

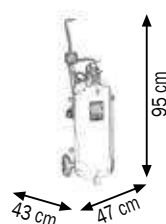

027-1312-000

They are advised for the filling and maintenance of oil. The tank has to be filled for 4/5 of its capacity and when air is put inside at 6-8 bar it works automatically without any continuous link to compressed air.



**027-1314-000**

## Art. 027-1314-000

65 l pneumatic oil dispenser

Composed by:

Tank capacity 65 l (with level indicator)

Art.024-1231-C00 Oil dispensing nozzle with flex. hose and aut.drop valve

Art.906-0404-030 Delivery hose 1SC 1/2 3 m length

Art.020-1190-000 Oil pump ratio=3:1 30 l/min

## Art. 027-1315-000

65 l pneumatic oil dispenser

Composed like Art.027-1314-000 but with:

Art.020-1200-000 Oil pump ratio=5:1 28 l/min



027-1314-000	29,000	0,210	2
027-1315-000	30,100	0,210	2

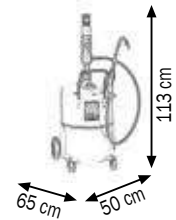

**027-1316-000**

## Art. 027-1316-000

65 l pneumatic oil dispenser with digital nozzle

Composed by:

Tank capacity 65 l (with level indicator)

Art.024-1233-C00 Oil **digital** nozzle with flex. hose and aut.drop valve

Art.906-0404-030 Delivery hose 1SC 1/2 3 m length

Art.020-1190-000 Oil pump ratio=3:1 30 l/min

## Art.027-1317-000

65 l pneumatic oil dispenser with digital nozzle

Composed like Art.027-1316-000 but with:

Art.020-1200-000 Oil pump ratio=5:1 28 l/min



027-1316-000	30,800	0,210	2
027-1317-000	31,000	0,210	2

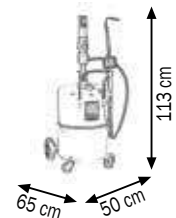

**027-1329-000**

## Art. 027-1329-000

65 l manual oil dispenser

Composed by:

Tank capacity 65 l (with level indicator)

Art.024-1232-F00 Oil dispensing nozzle with flex. hose and Man.drop valve

Art.902-0414-020 R6 1/2" hose M 1/2"- M 1/4" 2 m length

Double-acting manual oil pump

delivery quantity for each

lever action 250cc



027-1329-000	24,600	0,190	1
--------------	--------	-------	---

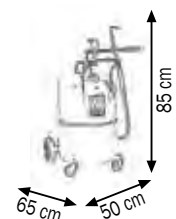

These equipment are supplied with pneumatic or manual pump, advised for the filling and maintenance of oils of every viscosity. The working pressure can swing between 3,5 - 8,5 bar obtaining a medium delivery of 13 l/min.





**027-1320-000**

**Art. 027-1320-000**

**16 l manual oil dispenser**

Composed by:

Tank capacity 16 l

Manual pump

Delivery hose 2,0 m length

With level valve, rigid end 30°

Flow rate: 80cc for each stroke



**027-1320-000** 10,000 0,090 1

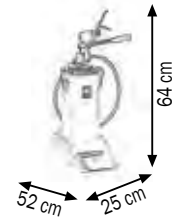

**027-1322-000**

**Art. 027-1322-000**

**16 l wheeled manual oil dispenser**

Composed by:

Tank capacity 16 l

Manual pump

Delivery hose 2,0 m length

With level valve, rigid end 30°

Flow rate: 80cc for each stroke



**027-1322-000** 11,900 0,090 1

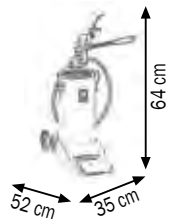

**027-1326-000**

**Art. 027-1326-000**

**24 l manual oil dispenser**

Composed by:

Tank capacity 24 l (with level indicator)

Double-acting manual pump

Oil dispensing nozzle with flexible hose and drop valve (Art.024-1232-F00)

Delivery hose 2,0 m length

Flow rate: 80cc for each stroke



**027-1326-000** 14,300 0,074 1

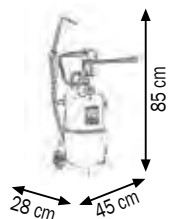

**027-1328-000**

**Art. 027-1328-000**

**50 l manual oil dispenser**

Composed by:

Tank capacity 50 l (with level indicator)

Double-acting manual pump

Oil dispensing nozzle with flexible hose and drop valve (Art.024-1232-F00)

Delivery hose 2,0 m length

Flow rate: 80cc for each stroke



**027-1328-000** 26,200 0,196 1

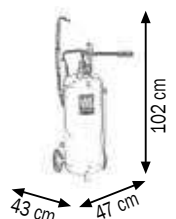

Manual oil dispensers with double-acting manual pump, suitable for high viscosity oils (SAE 15-220). They are advised for the filling or dispensing of motor oils, transmissions, differential gears, hydraulic power packs and so on.

## Art. 027-1336-000

Double-acting oil pump for drums of 50-220 l

Composed by:

Art.025-1262-000 Threaded ring M 2" Ø 42 mm for pumps fastening

Art.024-1232-F00 Oil dispensing nozzle with flex. hose and aut.drop valve

Art.902-0414-020 R6 1/2" hose M 1/2"- M 1/4" 2 m length

Art.095-5284-000 Telescopic suction hose with foot valve  
min 700 max 1000 mm length M1" inlet

Quantity of delivered oil for cycle 250cc



027-1336-000	6,200	0,031	1
--------------	-------	-------	---



027-1336-000

## Art. 027-1338-000

Double-acting wheeled oil pump for drums of 30-60 l

Composed by:

Art.027-1336-000 Manual pump

Art.030-1395-000 4-wheels trolley



027-1338-000	19,800	0,076	1
--------------	--------	-------	---

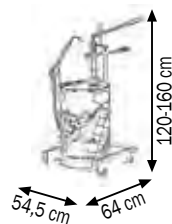

027-1338-000

## Art. 027-1325-000

Oil and diesel fuel transfer pump

Telescopic shank for drums of 30-220 l

Delivery capacity 30 l/min

## Art. 027-1325-A00

Transfer pump for anti-freeze liquid, solvents

Telescopic shank for drums of 30-220 l

Delivery capacity 30 l/min



027-1325-000	2,300	0,008	1
027-1325-A00	2,300	0,008	1

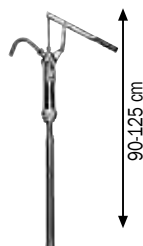

027-1325-000

They are suitable for the dispensing of low and high viscosity oils (SAE 15-220); they are prearranged for the direct application to the tank.



**027-3500-125**

**Art. 027-3500-125**

Oil syringe brass body capacity 125 cc

Suction-pressing type

Brass rigid hose with 30° bent

Body Ø 30 mm length 240 mm



027-3500-125 0,600 0,001 1



**027-3500-250**

**Art. 027-3500-250**

Oil syringe brass body capacity 250 cc

Suction-pressing type

Brass rigid hose with 30° bent

Body Ø 40 mm length 300 mm



027-3500-250 0,700 0,001 1



**027-3500-500**

**Art. 027-3500-500**

Oil syringe brass body capacity 500 cc

Suction-pressing type

Brass rigid hose with 30° bent

Body Ø 50 mm length 340 mm



027-3500-500 0,850 0,002 1



**027-3515-500**

**Art. 027-3515-500**

Professional oil syringe for high viscosity oil capacity 500 cc

Suction-pressing type

Steel body with straight rigid hose

and rigid hose 90° bent

Body Ø 50 mm length 410 mm



027-3515-500 1,800 0,003 1



**027-3521-000**

**Art. 027-3521-000**

Professional oil syringe for high viscosity oil capacity 1000 cc

Suction-pressing type

Steel body with straight rigid hose

and rigid hose 90° bent

Body Ø 57 mm length 530 mm



027-3521-000 2,200 0,003 1

## Oil cans with rigid spout

Plastic handle and tank

Polypropylene pump

Article	Capacity	Spout lenght
027-3600-200	200 cc	160 mm
027-3600-300	300 cc	160 mm
027-3600-500	500 cc	160 mm



027-3600-200

## Oil cans with flexible spout

Plastic handle and tank

Polypropylene pump

Article	Capacity	Spout lenght
027-3610-200	200 cc	170 mm
027-3610-300	300 cc	170 mm
027-3610-500	500 cc	170 mm



027-3610-200

## Oil cans with rigid spout

Steel handle and tank

Brass pump

Article	Capacity	Spout lenght
027-3620-200	200 cc	125 mm
027-3620-300	300 cc	125 mm
027-3620-500	500 cc	150 mm



027-3620-200

## Oil cans with flexible spout

Steel handle and tank

Brass pump

Article	Capacity	Spout lenght
027-3630-200	200 cc	150 mm
027-3630-300	300 cc	150 mm
027-3630-500	500 cc	175 mm



027-3630-200

## Rigid brass spout for oil cans Art.027-3600-200/300/500

Article	Spout	Spout lenght
027-3640-160	Rigid	160 mm



027-3640-160

## Flexible spout for oil cans Art.027-3610-200/300/500

Article	Spout	Spout lenght
027-3642-170	Flexible	170 mm



027-3642-170

## Rigid steel spout for oil cans Art.027-3620-200/300/500

Article	Spout	Spout lenght
027-3650-125	Rigid	125 mm
027-3650-150	Rigid	150 mm
027-3650-175	Rigid	175 mm

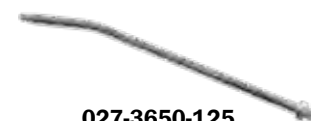

027-3650-125

## Flexible steel spout for oil cans Art.027-3630-200/300/500

Article	Spout	Spout lenght
027-3660-150	Flexible	150 mm
027-3660-175	Flexible	175 mm
027-3660-225	Flexible	225 mm



027-3660-150



027-3680-020

**Squeeze action oil cans**  
Polyethylene tank and plug  
Brass tube

Article	Capacity	Ø Tank	Tot. height
027-3680-020	20 cc	22 mm	160 mm
027-3680-050	50 cc	36 mm	160 mm



027-3690-100

**Squeeze action oil cans**  
Polyethylene tank and plug  
Brass tube

Article	Capacity	Ø Tank	Tot. height
027-3690-100	100 cc	45 mm	210 mm
027-3690-250	250 cc	60 mm	235 mm
027-3690-300	300 cc	65 mm	240 mm



**Polyethylene graduated decanters**  
With lid, flexible hose and plug

Article	Capacity	Flexible hose length
027-1354-000	1 l	185 mm
027-1355-000	2 l	185 mm
027-1356-000	5 l	185 mm

027-1354-000 027-1355-000 027-1356-000

027-1354-010	Flexible hose for decanters 1-2 l	185 mm
027-1356-010	Flexible hose for decanter 5 l	185 mm



027-1359-000

**Polyethylene funnel**  
With filter, flexible hose

Article	Ø Funnel	Flexible hose length
027-1359-000	190 mm	185 mm

**STAINLESS STEEL AIR-OPERATED TRANSFER PUMPS  
FOR ANTI-FREEZE AND WINDSCREEN LIQUID**



MECLUBE  
MADE IN ITALY

## Art. 029-0978-000

Stainless steel air-operated transfer pump  
Mod. 501X ratio=1:1 Delivery capacity 35 l/min

For wall-fixing or fixed positions

It allows different possibilities of application depending on the different accessories  
Viton seals

## Art. 029-0985-000

Stainless steel air-operated transfer pump  
Mod. 501X ratio=1:1 Delivery capacity 35 l/min

For standard drums of 180-220 l

(shank length 940 mm)

Viton seals

## Art. 029-0986-000

Stainless steel air-operated transfer pump  
Mod. 501X ratio=1:1 Delivery capacity 35 l/min

For IBC tank 1000 l

(shank length 1250 mm)

Viton seals



With threaded ring for drum connection.



029-0978-000	5,100	0,007	1
029-0985-000	6,800	0,016	1
029-0986-000	7,500	0,019	1

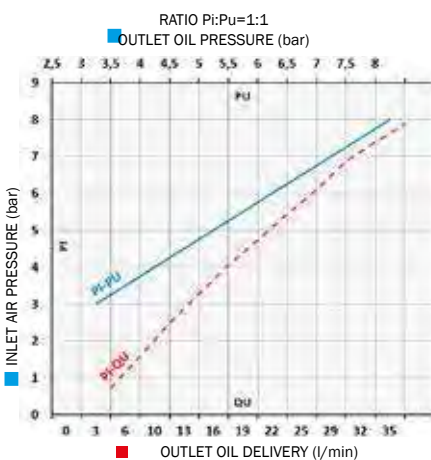
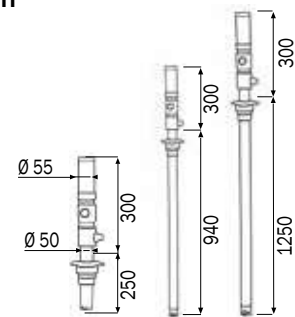

TECHNICAL DATA	029-0978-000	029-0985-000	029-0986-000
Compression ratio	1:1	1:1	1:1
Working pressure	bar	6-8	6-8
Air consumption	l/min	200	200
Air inlet connection	BSP	F 1/4" G	F 1/4" G
Oil outlet connection	BSP	M 1/2" G	M 1/2" G
Oil delivery capacity 8 bar	l/min	35	35
Noise	dB	80	80
Shank diameter	mm	50	50
Shank length	mm	245	940
For drums with capacity of	l	-	180-220
			1000 IBC

They are suitable for fast transferring of anti-freeze and windscreen liquid. The delivery capacity of a pump varies according to particular applications and combinations: the pressure of air supplied; viscosity and temperature of the fluid; dimensions of delivery hose; dimensions of connections and type of gun which is used. The operating pressure may vary between a minimum of 3 bar and a maximum of 8 bar. To optimize the performance and the time-life of the air-operated pumps we advise to use filtered and lubricated air.

# STAINLESS STEEL AIR-OPERATED TRANSFER PUMPS FOR ANTI-FREEZE AND WINDSCREEN LIQUID Mod. 603X

COMPRESSION RATIO = 3:1

DELIVERY CAPACITY = 30 l/min



## Art. 029-1374-000

Stainless steel air-operated transfer pump  
Mod. 603X ratio=3:1 Delivery capacity 30 l/min

For wall-fixing or fixed positions

It allows different possibilities of application depending on the different accessories

Viton seals

## Art. 029-1376-000

Stainless steel air-operated transfer pump  
Mod. 603X ratio=3:1 Delivery capacity 30 l/min

For standard drums of 180-220 l

(shank length 940 mm)

Viton seals

## Art. 029-1376-125

Stainless steel air-operated transfer pump  
Mod. 603X ratio=3:1 Delivery capacity 30 l/min

For IBC tank 1000 l

(shank length 1250 mm)

Viton seals

With threaded ring for drum connection.

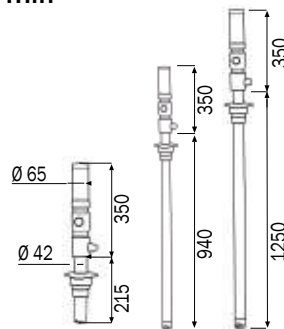

Art. No.	Weight (Kg)	Volume (m³)	Boxes
029-1374-000	8,200	0,007	1
029-1376-000	10,200	0,016	1
029-1376-125	11,000	0,019	1

TECHNICAL DATA		029-1374-000	029-1376-000	029-1376-125
Compression ratio		3:1	3:1	3:1
Working pressure	bar	6-8	6-8	6-8
Air consumption	l/min	220	220	220
Air inlet connection	BSP	F 1/4" G	F 1/4" G	F 1/4" G
Oil outlet connection	BSP	M 1/2" G	M 1/2" G	M 1/2" G
Oil delivery capacity 8 bar	l/min	30	30	30
Noise	dB	80	80	80
Shank diameter	mm	42	42	42
Shank length	mm	215	940	1250
For drums with capacity of	l	-	180-220	1000 IBC

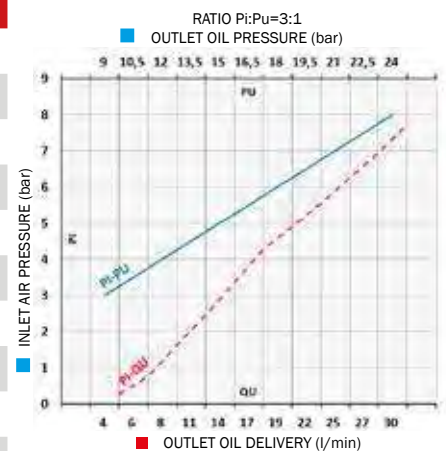

They are suitable for fast transferring of anti-freeze and windscreen liquid. The delivery capacity of a pump varies according to particular applications and combinations: the pressure of air supplied; viscosity and temperature of the fluid; dimensions of delivery hose; dimensions of connections and type of gun which is used. The operating pressure may vary between a minimum of 3 bar and a maximum of 8 bar. To optimize the performance and the time-life of the air-operated pumps we advise to use filtered and lubricated air.



## Art. 021-0905-XDT

Double-acting air-operated industrial disjunct pump stainless steel AISI 304 for chemical products

Mod. 905XD ratio=5:1 Delivery capacity 50 l/min

For wall-fixing or fixed positions.

Teflon seals

## Art. 021-1210-XDT

Double-acting air-operated industrial disjunct pump stainless steel AISI 304 for chemical products

Mod. 1210XD ratio=10:1 Delivery capacity 42 l/min

For wall-fixing or fixed positions.

Teflon seals

## Art. 021-1520-XDT

Double-acting air-operated industrial disjunct pump stainless steel AISI 304 for chemical products

Mod. 1520XD ratio=20:1 Delivery capacity 40 l/min

For wall-fixing or fixed positions.

Teflon seals

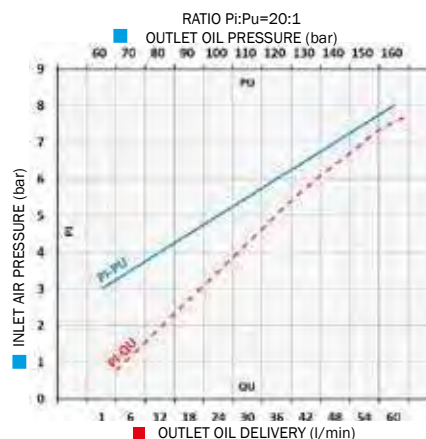
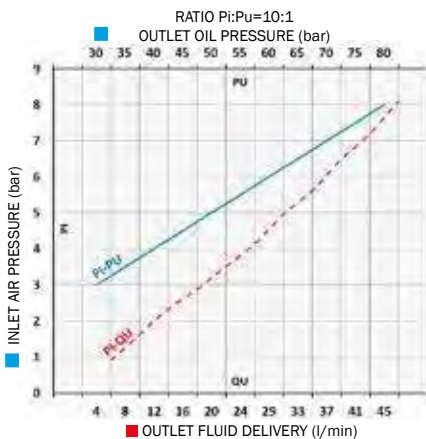
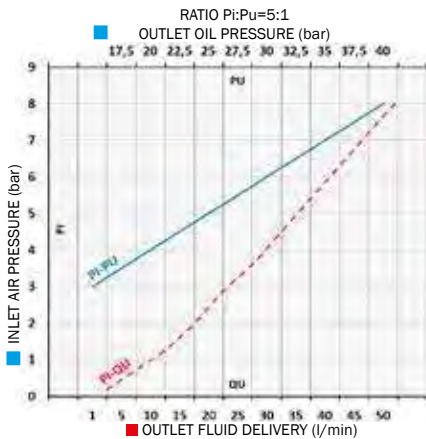

021-0905-XDT	24,100	0,110	1
021-1210-XDT	25,100	0,110	1
021-1520-XDT	27,900	0,110	1

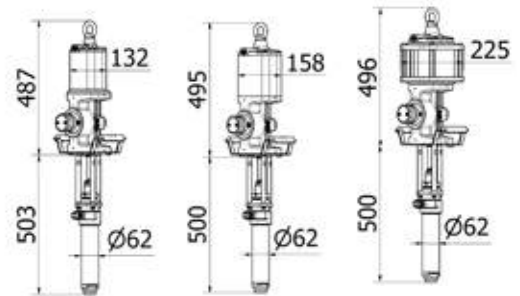

Technical Data	021-0905-XDT	021-1210-XDT	021-1520-XDT	
Compression ratio	5:1	10:1	20:1	
Working pressure	bar	6-8	8	
Air consumption	m <sup>3</sup> /min	1,70	2,90	3,50
Air inlet connection	BSP	F 1/2" G	F 1/2" G	F 1/2" G
Oil outlet connection	BSP	M 3/4" G	M 3/4" G	M 3/4" G
Oil delivery capacity 8 bar	l/min	50	42	40
Noise	dB	80	80	80
Shank diameter	mm	62	62	62
Shank length	mm	Modular F1"	Modular F1"	Modular F1"

Automatic engine body and shank kit are divided in order to avoid that the fluid enters directly in contact with device body.

These pumps are advised for the transfer of aggressive fluid and chemical products compatible with the material of the pump (**stainless steel and Teflon**).

The delivery capacity of a pump varies according to particular applications and combinations: the pressure of air supplied; viscosity and temperature of the fluid; dimensions of delivery hose; dimensions of connections and type of gun which is used. The operating pressure may vary between a minimum of 3 bar and a maximum of 8 bar. To optimize the performance and the time-life of the air-operated pumps we advise to use filtered and lubricated air.

## Art. 029-1380-000

### Wall-fixing kit for anti-freeze and windscreen liquid

Composed by:

Art.029-0978-000 Stainless steel air-operated pump **ratio=1:1 35 l/min**

Art.025-1265-000 Wall-fixing bracket

Art.025-1269-094 Ø 42mm stainless steel suction tube 940 mm length

Art.025-1262-000 Threaded ring Ø 42 mm for pumps fastening

Art.911-0600-020 Flex blue hose Ø 25 2,0 m length

Art.B27-1132-035 N.2 stainless steel screw clamps 32-35 mm

## Art. 029-1382-000

### Wall-fixing kit for anti-freeze and windscreen liquid

Composed by:

Art.029-1374-000 Stainless steel air-operated pump **ratio=3:1 30 l/min**

Art.025-1265-000 Wall-fixing bracket

Art.025-1269-094 Ø 42mm stainless steel suction tube 940 mm length

Art.025-1262-000 Threaded ring Ø 42 mm for pumps fastening

Art.911-0600-020 Flex blue hose Ø 25 2,0 m length

Art.B27-1132-035 N.2 stainless steel screw clamps 32-35 mm

029-1380-000	11,700	0,310	1
029-1382-000	14,800	0,310	1



029-1380-000

## Art. 029-1384-000

### Kit for anti-freeze liquid for drums of 180-220 l

Composed by:

Art.029-0985-000 Stainless steel air-operated pump **ratio=1:1 35 l/min**

Art.902-0404-030 R6 1/2" M-F hose 3,0 m length

Art.024-1237-A00 Anti-freeze liquid **digital** dispensing nozzle

## Art. 029-1383-000

### Kit for anti-freeze liquid for drums of 180-220 l

Composed like Art.029-1384-000 but with:

Art.024-1237-000 Anti-freeze liquid dispensing nozzle

029-1384-000	10,200	0,040	2
029-1383-000	9,600	0,040	2



029-1384-000

## Art. 029-1386-000

### Kit for windscreen liquid for drums of 180-220 l

Composed by:

Art.029-0985-000 Stainless steel air-operated pump **ratio=1:1 35 l/min**

Art.902-0404-030 R6 1/2" M-F hose 3,0 m length

Art.024-1237-W00 Windscreen liquid **digital** dispensing nozzle

## Art. 029-1385-000

### Kit for windscreen liquid for drums of 180-220 l

Composed like Art.029-1386-000 but with:

Art.024-1237-V00 Windscreen liquid dispensing nozzle

029-1386-000	9,300	0,040	2
029-1385-000	8,600	0,040	2



029-1386-000

## Art. 029-1388-000

Wheeled kit for anti-freeze liquid for drums of 180-220 l

Composed by:

Art.029-0985-000 **Stainless steel** air-operated pump **ratio=1:1** 35 l/min

Art.902-0404-030 R6 1/2" M-F hose 3,0 m length

Art.024-1237-A00 Anti-freeze liquid **digital** dispensing nozzle

Art.030-1400-000 Trolley for 180-220 l drums

## Art. 029-1387-000

Wheeled kit for anti-freeze liquid for drums of 180-220 l

Composed like Art.029-1388-000 but with:

Art.024-1237-000 Anti-freeze liquid dispensing nozzle



029-1388-000



029-1388-000	47,200	0,186	2
029-1387-000	46,600	0,186	2

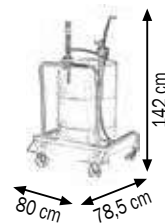
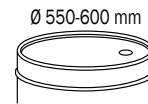

## Art. 029-1390-000

Wheeled kit for windscreen liquid for drums of 180-220 l

Composed by:

Art.029-0985-000 **Stainless steel** air-operated pump **ratio=1:1** 35 l/min

Art.902-0404-030 R6 1/2" M-F hose 3,0 m length

Art.024-1237-W00 Windscreen liquid **digital** dispensing nozzle

Art.030-1400-000 Trolley for 180-220 l drums

## Art. 029-1389-000

Wheeled kit for windscreen liquid for drums of 180-220 l

Composed like Art.029-1390-000 but with:

Art.024-1237-V00 Windscreen liquid dispensing nozzle



029-1389-000



029-1390-000	46,300	0,186	2
029-1389-000	45,600	0,186	2



## Art. 029-1410-000

### Anti-freeze liquid kit for IBC tank 1000 l

Composed by:

Art.029-0986-000 **Stainless steel** air-operated pump **ratio=1:1 35 l/min**

Art.014-1048-000 Regulator with filter and air lubricator 1/4"

Art.902-0202-020 R6 5/16" M-F hose 2,0 m length

Art.909-0424-010 EPDM 1/2" hose F-F 1/2" s-steel 1,0 m length

Art.070-1209-410 Fixed EPDM hose reel 1/2" 10,0 m length

Art.024-1237-A00 Anti-freeze liquid **digital** dispensing nozzle

Art.024-1785-000 Support for picking up drops for oil nozzle

Art.025-1267-000 Fixing tank bracket

Art.025-1267-B00 Fixing bracket for picking up drops



029-1410-000

The tank is not included in the kit

## Art. 029-1412-000

### Anti-freeze liquid kit for IBC tank 1000 l

Composed by Art.029-1410-000 but with:

Art.024-1237-000 Anti-freeze liquid dispensing nozzle

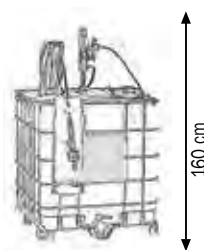

029-1410-000	43,500	0,120	4
029-1412-000	42,900	0,120	4

## Art. 029-1415-000

### Windscreen liquid kit for IBC tank 1000 l

Composed by:

Art.029-0986-000 **Stainless steel** air-operated pump **ratio=1:1 35 l/min**

Art.014-1048-000 Regulator with filter and air lubricator 1/4"

Art.902-0202-020 R6 5/16" M-F hose 2,0 m length

Art.909-0424-010 EPDM 1/2" hose F-F 1/2" s-steel 1,0 m length

Art.070-1209-410 Fixed EPDM hose reel 1/2" 10,0 m length

Art.024-1237-W00 Windscreen liquid **digital** dispensing nozzle

Art.024-1785-000 Support for picking up drops for oil nozzle

Art.025-1267-000 Fixing tank bracket

Art.025-1267-B00 Fixing bracket for picking up drops



029-1415-000

The tank is not included in the kit

## Art. 029-1416-000

### Windscreen liquid kit for IBC tank 1000 l

Composed by Art.029-1415-000 but with:

Art.024-1237-V00 Windscreen liquid dispensing nozzle

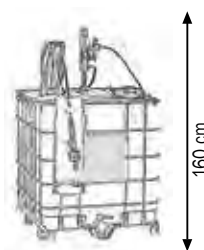

029-1415-000	43,200	0,120	4
029-1416-000	42,400	0,120	4



**029-1500-000**

## Art. 029-1500-000

### Diaphragm pump kit anti-freeze liquid for drums 200 l

Composed by:

Art.028-P055-TB3 Diaphragm pump P55TB R=1:1 55 l/min with:  
POM-C shank hose with threaded ring M 1/2" 940 mm l

Art.902-0404-030 R6 1/2" M-F hose 3,0 m lenght

Art.024-1237-A00 Anti-freeze **digital** dispensing nozzle

## Art. 029-1502-000

### Diaphragm pump kit anti-freeze liquid for drums 200 l

Composed like Art.029-1500-000 but with:

Art.024-1237-000 Anti-freeze dispensing nozzle



Ø 550-600 mm

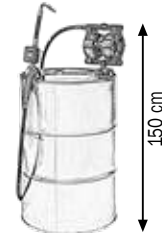

<b>029-1500-000</b>	8,300	0,043	2
<b>029-1502-000</b>	7,600	0,043	2

## Art. 029-1510-000

### Diaphragm pump kit windscreen liquid for drums 200 l

Composed by:

Art.028-P055-TB3 Diaphragm pump P55TB R=1:1 55 l/min with:

POM-C shank hose with threaded ring M 1/2" 940 mm l

Art.909-0404-030 EPDM 1/2" hose M-F R/stainless steel 3,0 m lenght

Art.024-1237-W00 Windscreen **digital** dispensing nozzle

## Art. 029-1512-000

### Diaphragm pump kit windscreen liquid for drums 200 l

Composed like Art.029-1510-000 but with:

Art.024-1237-V00 Windscreen dispensing nozzle



Ø 550-600 mm



<b>029-1510-000</b>	7,800	0,043	2
<b>029-1512-000</b>	7,100	0,043	2



**029-1510-000**

## Art. 029-1520-000

### Diaphragm pump kit for anti-freeze, windscreen and AdBlue® liquid for IBC tanks 1000 l

Composed by:

Art.028-P110-AB2 Diaphragm pump P110 R=1:1 110 l/min

Art.025-1266-002 Wall fixing bracket

Art.025-1271-125 Stainlees steel shank hose Ø42 1250 mm l flex 2,0 m lenght

Art.F94-1540-625 Stainlees steel connection fixet rubber M1" Ø25

Art.909-0500-060 EPDM hose Ø19 mm 6,0 m lenght

Art.B27-1120-032 N.2 stainless steel hose clamp 20x32 mm

Art.R1-9102-2006 Plastic fitting M 90° M 3/4" Ø20 mm

Art.099-5199-000 Manual plastic nozzle AD90

## Art. 029-1522-000

### Diaphragm pump kit for anti-freeze, windscreen and AdBlue® liquid for IBC tanks 1000 l

Composed like Art.029-1520-000 but with:

Art.099-5205-000 **Automatic** nozzle stainless steel end AP80



Ø 550-600 mm



<b>029-1520-000</b>	18,300	0,060	3
<b>029-1522-000</b>	18,800	0,060	3



**029-1520-000**

The tank is not included in the kit

Stainless steel air-operated and electric equipment for the bleeding of brakes and hydraulic clutches of every motor vehicle. Equipped with inside follower plate which allows the complete division between air and oil, avoiding the risk of emulsion.

Art.080-1788-000 and 080-1792-000 are equipped with a third air chamber which is filled with air at max 8 bar. Using a pressure reducer it is possible to make more bleeding operation with a constant pressure (1-3 bar) without any other filling in of air and oil.

For vehicles with ABS brake system the max pressure is 1 bar.



## Art. 080-1788-000

**Stainless steel brake bleeder-clutches with three chambers 6 l**

Composed by:

Oil tank capacity 6 l

4 m RILSAN spring hose

2 oil recovery basins 1 l

With hose and rubber 90° connection caps

1 filling funnel



080-1788-000

## Art. 080-1789-000

**Stainless steel brake bleeder-clutches with three chambers 6 l**

Composed like Art.080-1788-000 but with:

standard plugs (mod. 1-4-6-9-18-25)



080-1788-000	7,400	0,060	1
080-1789-000	8,000	0,060	1

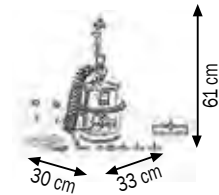

## Art. 080-1790-000

**Stainless steel brake bleeder-clutches with two chambers 10 l**

Composed by:

Oil tank capacity 10 l

4 m RILSAN spring hose

2 oil recovery basins 1 l

With hose and rubber 90° connection caps

1 filling funnel



080-1790-000

## Art. 080-1791-000

**Stainless steel brake bleeder-clutches with two chambers 10 l**

Composed like Art.080-1790-000 but with:

standard plugs (mod. 1-4-6-9-18-25)



080-1790-000	8,000	0,074	1
080-1791-000	8,600	0,074	1

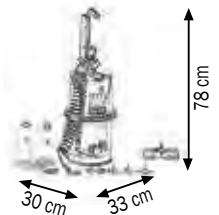

## Art. 080-1792-000

**Stainless steel brake bleeder-clutches with three chambers 10 l**

Composed by:

Oil tank capacity 10 l

4 m RILSAN spring hose

2 oil recovery basins 1 l

With hose and rubber 90° connection caps

1 filling funnel



080-1792-000

## Art. 080-1793-000

**Stainless steel brake bleeder-clutches with three chambers 10 l**

Composed like Art.080-1792-000 but with:

standard plugs (mod. 1-4-6-9-18-25)



080-1792-000	8,200	0,074	1
080-1793-000	8,800	0,074	1

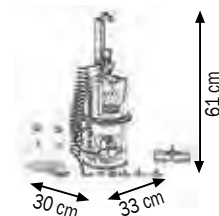

## Art. 081-1796-000

Electric brake bleeder 12V (0,192 kW) ABS with 5 screw plugs mod. 1 - 4 - 6 - 9 - 18 and 1 universal plug mod. 25

Composed by:

Oil tank capacity 1,5 l

4 m RILSAN spring hose

2 oil recovery basins 1 l

With hose and rubber 90° connection caps

1 filling funnel



081-1796-000

7,400

0,040

1

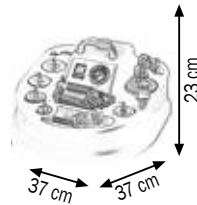

081-1796-000

## NEW MODEL

## FEATURES

**Pressure regulators with pressure gauge**

Automatic depressurisation from 1 to 3 bar

Suitable for ABS systems and clutches

of car, light and industrial vehicles

and trailers





**083-1800-000**



**Art. 083-1800-000**

Standard plugs kit composed by:  
5 plugs mod. 1-4-6-9-18  
1 universal plug mod. 25

**Art. 083-1801-000**

Screw plug model 1 Ø 25

**Art. 083-1802-000**

Screw plug model 2 Ø 21,5

**Art. 083-1803-000**

Screw plug model 3 Ø 26,5

**Art. 083-1804-000**

Screw plug model 4 Ø 43

**Art. 083-1805-000**

Screw plug model 5 Ø 48

**Art. 083-1806-000**

Screw plug model 6 Ø 52,5

**Art. 083-1807-000**

Screw plug model 7 Ø 64

**Art. 083-1808-000**

Screw plug model 8 Ø 42

**Art. 083-1809-000**

Screw plug model 9 Ø 60

**Art. 083-1810-000**

Screw plug model 10 Ø 77

**Art. 083-1811-000**

Screw plug model 11 Ø 68,5

**Art. 083-1812-000**

Screw plug model 12 Ø 62,8

**Art. 083-1813-000**

Screw plug model 13 Ø 61,5

**Art. 083-1814-000**

Screw plug model 14 Ø 72

**Art. 083-1815-000**

Screw plug model 15 Ø 82

**Art. 083-1816-000**

Screw plug model 16 Ø 33,3

**Art. 083-1817-000**

Screw plug model 17 Ø 28,6

**Art. 083-1818-000**

Screw plug model 18 Ø 44,5

**Art. 083-1819-000**

Screw plug model 19 Ø 75,5

**Art. 083-1820-000**

Screw plug model 20 Ø 39,4

**Art. 083-1821-000**

Screw plug model 21 Ø 31,2

**Art. 083-1822-000**

Screw plug model 22 Ø 44,5

**Art. 083-1823-000**

Screw plug model 23 Ø 58,2

**Art. 083-1825-000**

Universal plug model 25 (with 1 conic pad)



**083-1825-000**

It can be used on all kind of cars and trucks behind those mentioned in the plugs list.

**NOTE:** For the choice of the connection plug, please look in the table "LIST OF PLUGS FOR BRAKE BLEEDERS AND CLUTCHES"

**Art. 083-1826-000**

Pressure plugs kit suitable for Japanese and Korean cars

Composed by:

Universal bracket (Art.083-1826-S00)

9 plugs Art.083-1826-A/B/C/D/E/F/G/H/I00



**083-1826-000**

**Art. 083-1826-S00**

Univ. adjustable bracket without plugs



**083-1826-S00**

**Art. 083-1826-A00**

Pressure plug Ø 33,7

**Art. 083-1826-B00**

Pressure plug Ø 35,8

**Art. 083-1826-C00**

Pressure plug Ø 42,2

**Art. 083-1826-D00**

Pressure plug Ø 42,8

**Art. 083-1826-E00**

Pressure plug Ø 54

**Art. 083-1826-F00**

Pressure plug Ø 56

**Art. 083-1826-G00**

Pressure plug Ø 58,8

**Art. 083-1826-H00**

Pressure plug Ø 65,7

**Art. 083-1826-I00**

Pressure plug Ø 74,2



**083-1826-A00**

**083-1826-B00**

**083-1826-C00**

**083-1826-D00**

**083-1826-E00**

**083-1826-F00**

**083-1826-G00**

**083-1826-H00**



**083-1826-I00**

**Art. 083-1828-000**

Connection hose suitable for double – tank plants



**083-1828-000**

**Art. 083-1829-000**

Connection hose for bleed clutches

600 mm length



**083-1829-000**

**Art. 083-1830-000**

Oil recovery basin 1 l

With hose and rubber 90° connection caps



**083-1830-000**



**083-1834-000**

**Art. 083-1834-000**

Filling funnel Ø 120mm

**NOTE:** For the choice of the connection plug, please look in the table “LIST OF PLUGS FOR BRAKE BLEEDERS AND CLUTCHES”



## SCREW PLUGS

	1	2	3	4	5	6	7	8	9	10	11	12	13	14	15	16	17	18	19	20	21	22	23	25
ALFA	x			x						x														
AUDI				x																				
AUSTIN MORRIS	x			x														x						
AUTOBIANCHI		x						x																
BMW				x																	x			x
CITROËN				x	x				x															
CRYSLER				x																				x
DAEWOO				x																				x
FERRARI				x			x	x																
FIAT	x	x		x				x	x															
FORD	x																	x						
HONDA																								
HONDA																								
HYUNDAI																								x
INNOCENTI	x			x						x														
ISUZU								x																
JAGUAR	x			x						x														
JEEP																								x
KIA				x																				
LADA				x				x																
LAMBORGHINI				x				x																x
LANCIA				x				x																x
LAND ROVER																		x						x
LEXUS																								
LEYLAND	x																							
MASERATI				x			x	x		x														
MAZDA				x																				x
MERCEDES				x																				
MINI																								
MITSUBISHI										x									x					x
MG																								x
NISSAN																		x						x
NISSAN																								
OPEL				x		x							x											
PEUGEOT				x		x					x													
PORSCHE			x	x																				
RENAULT				x			x		x	x														
ROVER	x			x						x														x
SAAB				x																				
SEAT				x				x																
SKODA				x	x														x					
SUBARU				x						x										x				x
SUZUKI				x		x																		x
TALBOT				x																				
TOYOTA																								x
TRIUMPH																			x					
VAUXHALL	x																							
VOLKSWAGEN				x	x																			
VOLVO				x				x												x				

## PRESSURE PLUGS

	A	B	C	D	E	F	G	H	I
ALFA									
AUDI									
AUSTIN MORRIS									
AUTOBIANCHI									
BMW									
CITROËN									
CRYSLER									
DAEWOO									
FERRARI									
FIAT									
FORD									
HONDA									
HONDA									
HYUNDAI									
INNOCENTI									
ISUZU									
JAGUAR									
JEEP									
KIA									
LADA									
LAMBORGHINI									
LANCIA									
LAND ROVER									
LEXUS									
LEYLAND									
MASERATI									
MAZDA									
MERCEDES									
MINI									
MITSUBISHI									
MG									
NISSAN									
NISSAN									
OPEL									
PEUGEOT									
PORSCHE									
RENAULT									
ROVER									
SAAB									
SEAT									
SKODA									
SUBARU									
SUZUKI									
TALBOT									
TOYOTA									
TRIUMPH									
VAUXHALL									
VOLKSWAGEN									
VOLVO									

## SCREW PLUGS

	1	2	3	4	5	6	7	8	9	10	11	12	13	14	15	16	17	18	19	20	21	22	23	25
ASTRA								x																
BEDFORD	x						x			x														
DAF				x																				
EBRO					x				x															
FIAT	x	x		x		x		x	x			x		x							x			
FORD				x			x								x									
IVECO				x				x		x														
MAN			x																					
MERCEDES				x																				
PEGASO						x																		
RENAULT				x						x													x	x
SCANIA				x			x																	
UNIC						x		x	x					x										
VOLVO				x													x							



**TRUCKS BRAND  
SCREWS PLUGS**



They are necessary  
for the bleeding of brakes  
of HYDRAULIC CLUTCHES OF TRACTORS

# AIR-OPERATED DOUBLE DIAPHRAGM PUMPS



Air-operated double diaphragm pumps have long been recognized as the most flexible pumps of the industry for handling difficult liquids at relatively low pressures and flows. The range of applications is virtually limitless. Meclube AODD pumps come in many sizes and choices of materials of construction. Almost every type of liquid can be pumped from highly corrosive acids through high viscosity paints and adhesives, to food and drink products.



- Special air system: lube-free, anti-stall, anti-freeze.
- Efficient air distribution design: low air consumption.
- Handled liquids with solids particles: ideal for abrasive and viscous fluids.
- All plastic air system: strong and corrosion-resistant in harsh environments.
- Efficient performance: high flow rates through optimal casing designs.
- They can be customized for specific applications:
- Multiple porting options available along with interface options.
- All bolted Construction: it provides maximum leak resistance and safety.
- Variable flow and head pressures, easy to adjust, without sophisticated controls.
- Wide range of sizes and materials suited to variety of conditions and chemicals fluids.
- Safely “dead head” function, against closed discharge, without pump damage.
- Self-priming dry up to 6 meters: works in suction lift applications.
- 100% wet tested after final assembly: deadheading, priming, and sealing.



## 1. Suction Cycle

Compressed air fills right inner chamber, causing the opposing diaphragm to create suction, lifting the lower valve ball, pulling in fluid at inlet. Simultaneously, the right chamber is in “Discharge” cycle.



## 2. Discharge Cycle

Compressed air fills left inner chamber, causing upper valve ball to open and discharge fluid. Simultaneously, the right chamber is in “Suction” cycle.



Air-operated double diaphragm pumps made of **POLYPROPYLENE**  
Flow-rate from 7 l/min to 700 l/min  
Connection from **1/4" to 2"**

page 183



Air-operated double diaphragm pumps made of **ALUMINIUM**  
Flow-rate from 35 l/min to 1050 l/min  
Connection from **1/2" to 3"**

page 192



Air-operated double diaphragm pumps made of **STAINLESS STEEL AISI 316**  
Flow-rate from 20 l/min to 700 l/min  
Connection from **3/8" to 2"**

page 200



Air-operated double diaphragm pumps "**FOOD**" made of **ELECTRO-POLISHED STAINLESS STEEL AISI 316**  
Flow-rate from 20 l/min to 700 l/min  
Connection from **3/4" to 2.1/2" Tri-Clamp**

page 208



Air-operated double diaphragm pumps "**DRUM-MEC**" made of **POLYPROPYLENE AND ALUMINIUM**  
Flow-rate from 55 l/min to 110 l/min  
Connection from **1/2" to 3/4"**

page 216



Air-operated double diaphragm pumps "**TWIN-MEC**" made of **ALUMINIUM**  
Flow-rate from 55 l/min to 110 l/min  
Connection from **1/2" to 3/4"**

page 218



Components for compressed air  
• **Pressure regulators**  
• **Pressure regulators with filter**  
• **Compressed air lubricator**  
• **Pressure regulators with lubricating filter**

page 219



Pneumatic automatic pulsation dampers realized in **POLYPROPYLENE PVDF, POMc, STAINLESS STEEL AISI 316**  
Flow-rate from 35 l/min to 1000 l/min  
Connection from **3/4" to 2"**

page 220



Accessories for air-operated double diaphragm pumps  
• **Wall fixing bracket**  
• **Stainless steel trolley**  
• **Flange connection kit**  
• **Suction hoses kit**  
• **Chemical compatibility table**

page 222

To select the right MECLUBE pump for your application, the following factors should be considered to achieve economy of operation, long pump life, and minimal maintenance costs:

- The nature of the fluid to be pumped, its viscosity, and the contained solids content
- Pumping capacity in relation to the desired output
- Suction and pressure conditions

Considering these parameters, an optimal pump size is selected when the intersection of the intended installation "pressure vs. flow rate" is near the middle section of the curves.

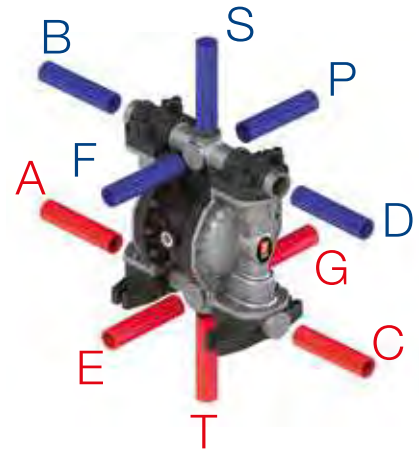

## Feasible Connection

- Standard = A B
- Inlet = A-E-T-C-G
- Outlet = B-S-D-F-P

CORPO	MEMBRANE	SFERE	SEDE SFERA	GUARNIZIONI	CONNESSIONI	ATEX	PORTE
POLIPROPILENE	HYTREL+PTFE	PTFE	PP	EPDM	BSP	ZONE2	A B= STANDARD
PVDF	SANTOPRENE+PTFE	SS	PVDF	VITON	FLANGED	ZONE1	
ALLUMINIO	HYTREL	EPDM	ALU	NBR	NPT		
ACCIAIO INOX	SANTOPRENE-EPDM NBR	NBR	SS-PE-UHMWE	PTFE			

## Using Performance Curves

To determine compressed air requirements and proper size for a MECLUBE AODD pump, two elements of information are required:

- 1 Required Flow Rate
- 2 Total Delivery Head

As an example, consider a P170 pump performance curve, pumping about 135 l/min at 25m.

Point A on the performance curve is where the desired Flow Rate and Total Delivery Head points intersect. This point determines compressed air requirements for the particular pump.

At performance point A, the pump will require approximately 7 bar air inlet pressure.

To arrive at this figure, follow the solid blue curve to the left to read the air pressure rating in BAR.

By looking at the nearest green curve, it is determined the pump will require approximately 900 nl/min (Normal Liter per minute) of air consumption.



## Specified Suction Lift

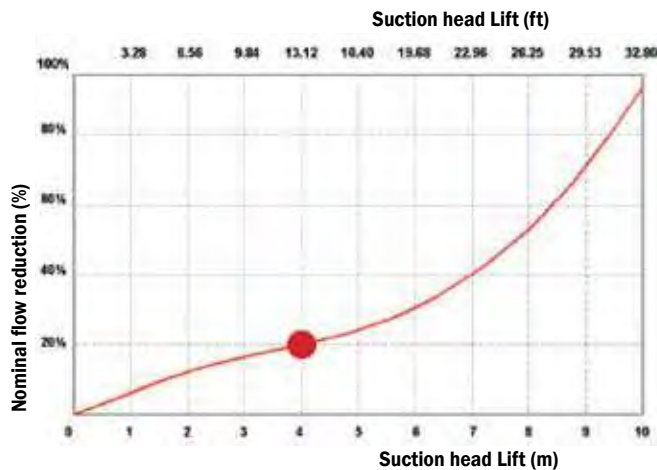

With a suction lift of 4 m, pump rate decreases by approximately 20%. Valid for pumps 3/4" and larger; data varies according to the pump configuration.

## Viscous Liquids Performance Data

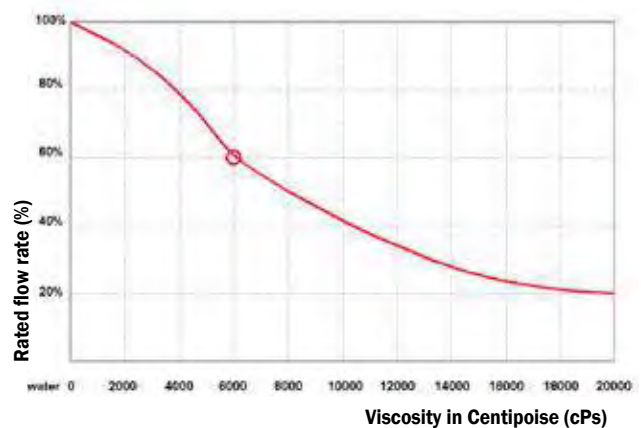

During the delivery of a fluid with a viscosity of 6000cPs, the pump rate decreases to 60% of its rated value (100% = water). Valid for 3/4" pumps & larger.

Technical data are approximate and not binding for the manufacturer who reserves the right to change them without notice at any time.

## Meclube Model P7

Made of POLYPROPYLENE

Compression ratio: 1:1  
 Max flow-rate: 7 l/min  
 Fluid connections: 1/4" BSP



EX II 3/3 GD h IIB T4 135°C ATEX zone2

ARTICLE	CASING	DIAPHRAGM	BALLS	GASKET	FLUIDS
028-P007-AB1	POLYPROPYLENE	NBR+PTFE	SS AISI 316	NBR	oil-exhausted oil-diesel fuel
028-P007-AB2	POLYPROPYLENE	NBR+PTFE	PTFE	VITON	water-anti-freeze-windscreen-urea-AdBlue
028-P007-AB3	POLYPROPYLENE	NBR+PTFE	PTFE	PTFE	aggressive fluids (acids and basics)

### Performance

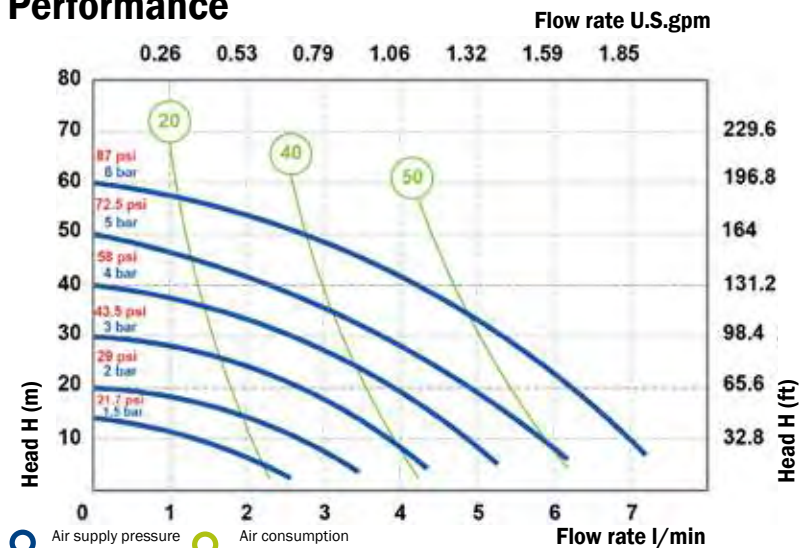

The curves and performance values refer to pumps with submerged suction and a free delivery outlet with water at 20°C, and vary according to the construction material.

### Technical data

Fluid connections: **1/4" BSP**  
 Air connection: **4 mm**  
 Max flow-rate: **7 l/min**  
 Max air pressure: **6 bar**  
 Max delivery head: **60 m**  
 Max Suction Lift Dry: **3,0 m**  
 Max Suction Lift Wet: **9,8 m**  
 Max Solid passing: **2 mm**  
 Noise level: **62 dB**  
 Displacement per cycle: **18 cm<sup>3</sup>**  
 Max Viscosity: **5000 cps**

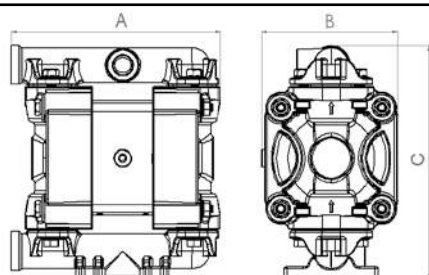

### Dimensions

P7	
A (mm)	129
B (mm)	68
C (mm)	112
Gross weight kg	0,91
MAX Temperature	-4°C + 65°C



## Meclube Model P20

Made of POLYPROPYLENE

Compression ratio:

1:1

Max flow-rate:

20 l/min

Fluid connections:

3/8" BSP

 EX II 3/3 GD h IIB T4 135 °C ATEX zone2

ARTICLE	CASING	DIAPHRAGM	BALLS	GASKET	FLUIDS
<b>028-P020-AB1</b>	POLYPROPYLENE	HYTREL+PTFE	SS AISI 316	NBR	oil-exhausted oil-diesel fuel
<b>028-P020-AB2</b>	POLYPROPYLENE	HYTREL+PTFE	PTFE	VITON	water-anti-freeze-windscreen-urea-AdBlue
<b>028-P020-AB3</b>	POLYPROPYLENE	HYTREL+PTFE	PTFE	PTFE	aggressive fluids (acids and basics)

### Technical data

Fluid connections:	<b>3/8" BSP</b>
Air connection:	<b>6 mm</b>
Max flow-rate:	<b>20 l/min</b>
Max air pressure:	<b>7 bar</b>
Max delivery head:	<b>70 m</b>
Max Suction Lift Dry:	<b>5,0 m</b>
Max Suction Lift Wet:	<b>9,8 m</b>
Max Solid passing:	<b>2,5 mm</b>
Noise level:	<b>65 dB</b>
Displacement per cycle:	<b>30 cm<sup>3</sup></b>
Max Viscosity:	<b>10000 cps</b>

### Performance

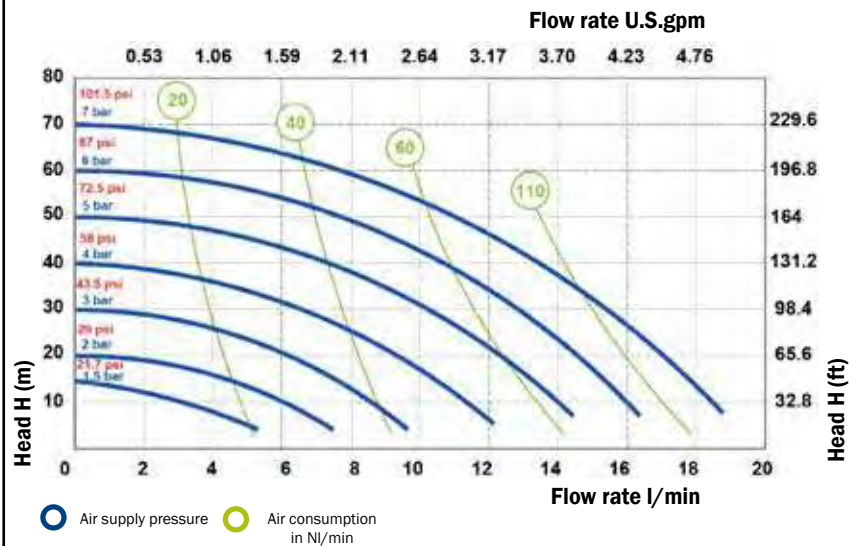

The curves and performance values refer to pumps with submerged suction and a free delivery outlet with water at 20 °C, and vary according to the construction material.

### Dimensions

#### P20

A (mm)	146
B (mm)	96
C (mm)	167
Gross weight kg	1,43
MAX Temperature	-4 °C + 65 °C

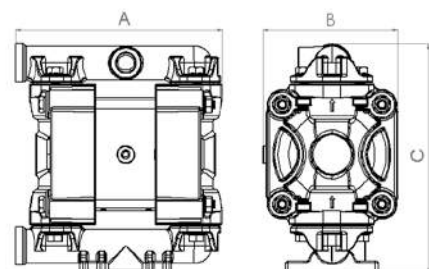

## Meclube Model P35

Made of POLYPROPYLENE

Compression ratio: 1:1  
 Max flow-rate: 35 l/min  
 Fluid connections: 1/2" BSP



EX II 3/3 GD h IIB T4 135°C ATEX zone2

ARTICLE	CASING	DIAPHRAGM	BALLS	GASKET	FLUIDS
028-P035-AB1	POLYPROPYLENE	HYTREL	SS AISI 316	NBR	oil-exhausted oil-diesel fuel
028-P035-AB2	POLYPROPYLENE	HYTREL+PTFE	PTFE	VITON	water-anti-freeze-windscreen-urea-AdBlue
028-P035-AB3	POLYPROPYLENE	HYTREL+PTFE	PTFE	PTFE	aggressive fluids (acids and basics)
028-P035-AB4	POLYPROPYLENE	SANTOPRENE	EPDM	EPDM	abrasive liquids - alkaline/basic

### Performance

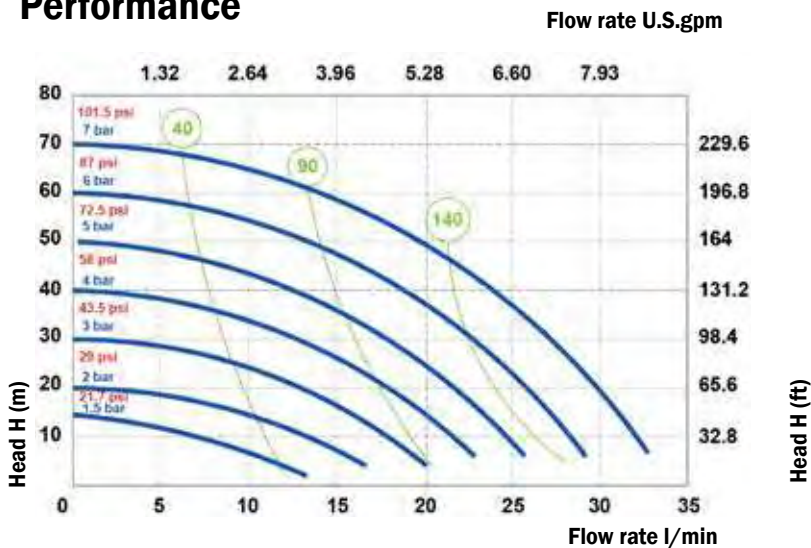

The curves and performance values refer to pumps with submerged suction and a free delivery outlet with water at 20°C, and vary according to the construction material.

### Technical data

Fluid connections:	<b>1/2" BSP</b>
Air connection:	<b>6 mm</b>
Max flow-rate:	<b>35 l/min</b>
Max air pressure:	<b>7 bar</b>
Max delivery head:	<b>70 m</b>
Max Suction Lift Dry:	<b>5,0 m</b>
Max Suction Lift Wet:	<b>9,8 m</b>
Max Solid passing:	<b>3 mm</b>
Noise level:	<b>65 dB</b>
Displacement per cycle:	<b>65 cm<sup>3</sup></b>
Max Viscosity:	<b>15000 cps</b>

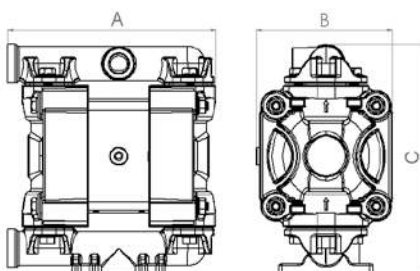

### Dimensions

#### P35

A (mm)	177
B (mm)	105
C (mm)	185
Gross weight kg	2,14
MAX Temperature	-4°C + 65°C



## Meclube Model P55

Made of POLYPROPYLENE

Compression ratio: 1:1

Max flow-rate: 55 l/min

Fluid connections: 1/2" BSP

 EX II 3/3 GD h IIB T4 135 °C ATEX zone2

ARTICLE	CASING	DIAPHRAGM	BALLS	GASKET	FLUIDS
<b>028-P055-AB1</b>	POLYPROPYLENE	HYTREL	SS AISI 316	NBR	oil-exhausted oil-diesel fuel
<b>028-P055-AB2</b>	POLYPROPYLENE	HYTREL+PTFE	PTFE	VITON	water-anti-freeze-windscreen-urea-AdBlue
<b>028-P055-AB3</b>	POLYPROPYLENE	HYTREL+PTFE	PTFE	PTFE	aggressive fluids (acids and basics)
<b>028-P055-AB4</b>	POLIPROPILENE	SANTOPRENE	EPDM	EPDM	abrasive liquids - alkaline/basic

### Technical data

Fluid connections:	<b>1/2" BSP</b>
Air connection:	<b>1/4" BSP</b>
Max flow-rate:	<b>55 l/min</b>
Max air pressure:	<b>8 bar</b>
Max delivery head:	<b>80 m</b>
Max Suction Lift Dry:	<b>5,0 m</b>
Max Suction Lift Wet:	<b>9,8 m</b>
Max Solid passing:	<b>3,5 mm</b>
Noise level:	<b>70 dB</b>
Displacement per cycle:	<b>140 cm<sup>3</sup></b>
Max Viscosity:	<b>20000 cps</b>

### Performance

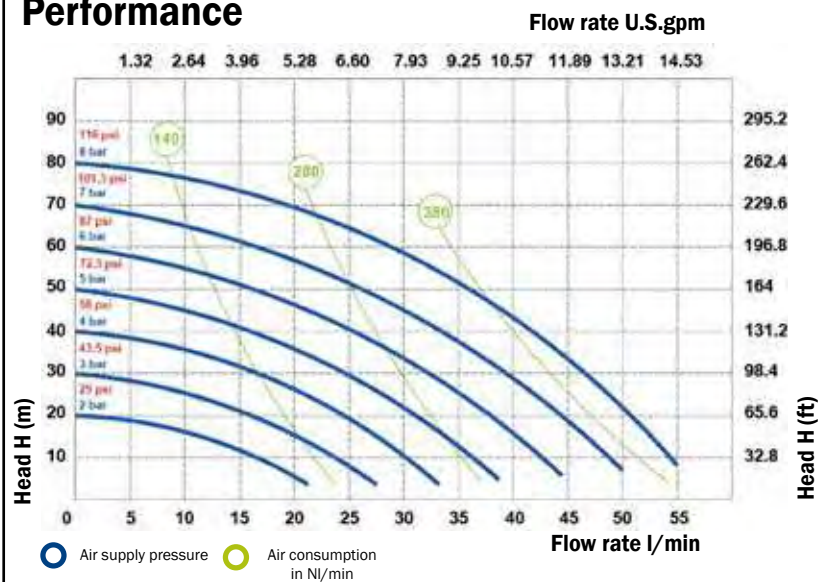

The curves and performance values refer to pumps with submerged suction and a free delivery outlet with water at 20 °C, and vary according to the construction material.

### Dimensions

#### P55

A (mm)	238
B (mm)	156
C (mm)	249
Gross weight kg	4,15
MAX Temperature	-4 °C + 65 °C

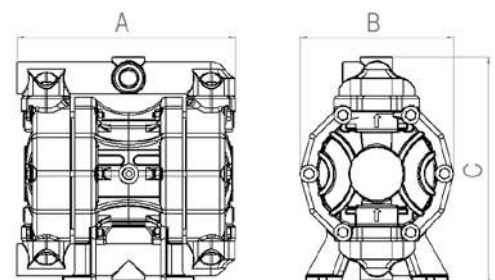

## Meclube Model P110

Made of POLYPROPYLENE

Compression ratio: 1:1  
 Max flow-rate: 110 l/min  
 Fluid connections: 3/4" BSP



EX II 3/3 GD h IIB T4 135°C ATEX zone2

ARTICLE	CASING	DIAPHRAGM	BALLS	GASKET	FLUIDS
028-P110-AB1	POLYPROPYLENE	HYTREL	SS AISI 316	NBR	oil-exhausted oil-diesel fuel
028-P110-AB2	POLYPROPYLENE	HYTREL+PTFE	PTFE	VITON	water-anti-freeze-windscreen-urea-AdBlue
028-P110-AB3	POLYPROPYLENE	HYTREL+PTFE	PTFE	PTFE	aggressive fluids (acids and basics)
028-P110-AB4	POLYPROPYLENE	SANTOPRENE	EPDM	EPDM	abrasive liquids - alkaline/basic

### Performance

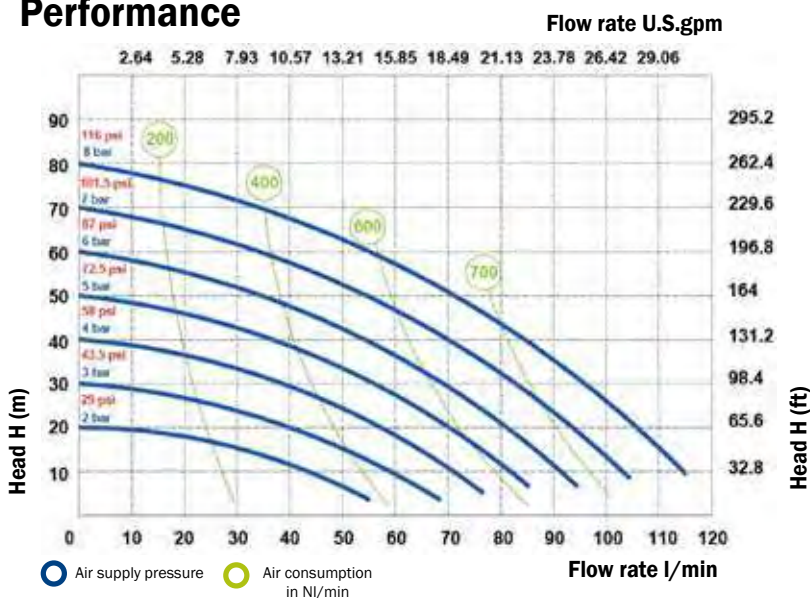

The curves and performance values refer to pumps with submerged suction and a free delivery outlet with water at 20°C, and vary according to the construction material.

### Technical data

Fluid connections: **3/4" BSP**  
 Air connection: **3/8" BSP**  
 Max flow-rate: **110 l/min**  
 Max air pressure: **8 bar**  
 Max delivery head: **80 m**  
 Max Suction Lift Dry: **5,0 m**  
 Max Suction Lift Wet: **9,8 m**  
 Max Solid passing: **4 mm**  
 Noise level: **72 dB**  
 Displacement per cycle: **200 cm<sup>3</sup>**  
 Max Viscosity: **25000 cps**

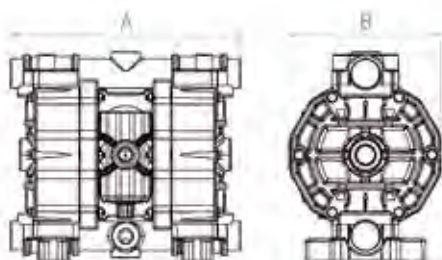

### Dimensions

P110	
A (mm)	293
B (mm)	176
C (mm)	280
Gross weight kg	5,10
MAX Temperature	-4°C + 65°C



## Meclube Model P170

Made of POLYPROPYLENE

Compression ratio: **1:1**  
 Max flow-rate: **170 l/min**  
 Fluid connections: **1" BSP**

 EX II 3/3 GD h IIB T4 135 °C ATEX zone2

ARTICLE	CASING	DIAPHRAGM	BALLS	GASKET	FLUIDS
<b>028-P170-AB1</b>	POLYPROPYLENE	HYTREL	SS AISI 316	NBR	oil-exhausted oil-diesel fuel
<b>028-P170-AB2</b>	POLYPROPYLENE	HYTREL+PTFE	PTFE	VITON	water-anti-freeze-windscreen-urea-AdBlue
<b>028-P170-AB3</b>	POLYPROPYLENE	HYTREL+PTFE	PTFE	PTFE	aggressive fluids (acids and basics)
<b>028-P170-AB4</b>	POLIPROPYLENE	SANTOPRENE	EPDM	EPDM	abrasive liquids - alkaline/basic

### Technical data

Fluid connections:	<b>1" BSP</b>
Air connection:	<b>1/2" BSP</b>
Max flow-rate:	<b>170 l/min</b>
Max air pressure:	<b>8 bar</b>
Max delivery head:	<b>80 m</b>
Max Suction Lift Dry:	<b>5,0 m</b>
Max Suction Lift Wet:	<b>9,8 m</b>
Max Solid passing:	<b>7,5 mm</b>
Noise level:	<b>75 dB</b>
Displacement per cycle:	<b>700 cm<sup>3</sup></b>
Max Viscosity:	<b>35000 cps</b>

### Performance



The curves and performance values refer to pumps with submerged suction and a free delivery outlet with water at 20 °C, and vary according to the construction material.

### Dimensions

#### P170

A (mm)	396
B (mm)	222
C (mm)	387
Gross weight kg	12,27
MAX Temperature	-4 °C + 65 °C

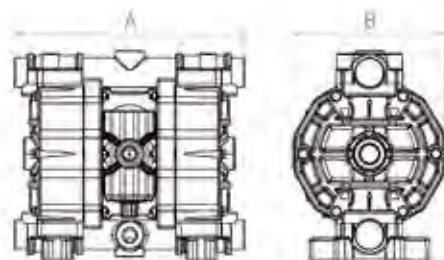

## Meclube Model P250

Made of POLYPROPYLENE

Compression ratio: 1:1  
 Max flow-rate: 250 l/min  
 Fluid connections: 1.1/4" BSP



EX II 3/3 GD h IIB T4 135°C ATEX zone2

ARTICLE	CASING	DIAPHRAGM	BALLS	GASKET	FLUIDS
028-P250-AB1	POLYPROPYLENE	HYTREL	SS AISI 316	NBR	oil-exhausted oil-diesel fuel
028-P250-AB2	POLYPROPYLENE	HYTREL+PTFE	PTFE	VITON	water-anti-freeze-windscreen-urea-AdBlue
028-P250-AB3	POLYPROPYLENE	HYTREL+PTFE	PTFE	PTFE	aggressive fluids (acids and basics)
028-P250-AB4	POLIPROPILENE	SANTOPRENE	EPDM	EPDM	abrasive liquids - alkaline/basic

### Performance

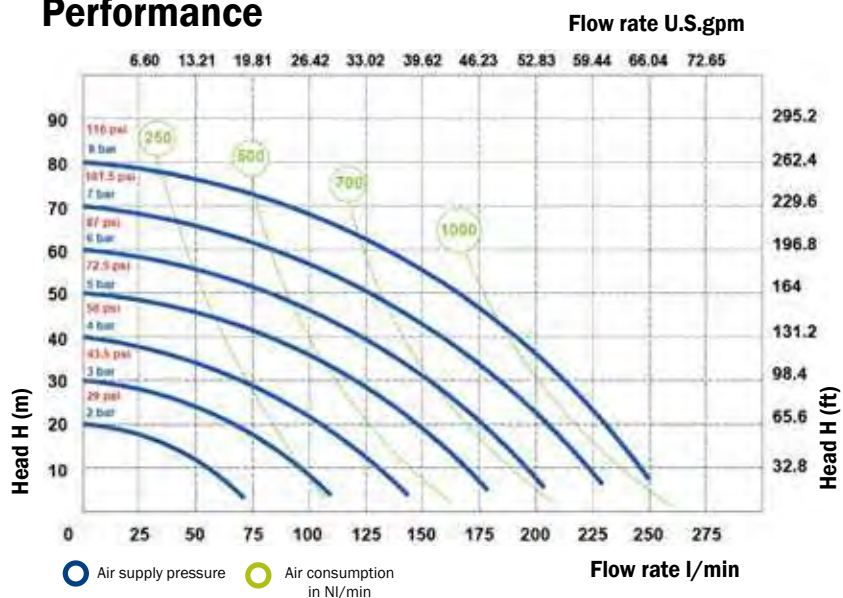

The curves and performance values refer to pumps with submerged suction and a free delivery outlet with water at 20°C, and vary according to the construction material.

### Technical data

Fluid connections: **1.1/4" BSP**  
 Air connection: **1/2" BSP**  
 Max flow-rate: **250 l/min**  
 Max air pressure: **8 bar**  
 Max delivery head: **80 m**  
 Max Suction Lift Dry: **5,0 m**  
 Max Suction Lift Wet: **9,8 m**  
 Max Solid passing: **7,5 mm**  
 Noise level: **75 dB**  
 Displacement per cycle: **700 cm³**  
 Max Viscosity: **35000 cps**

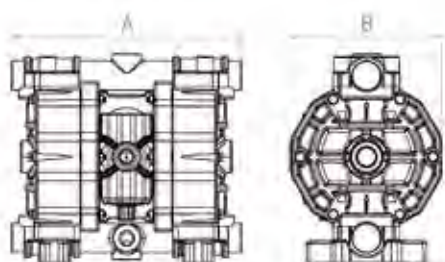

### Dimensions

P250	
A (mm)	396
B (mm)	222
C (mm)	388
Gross weight kg	12,73
MAX Temperature	-4°C + 65°C



## Meclube Model P400

Made of POLYPROPYLENE

Compression ratio: **1:1**

Max flow-rate: **400 l/min**

Fluid connections: **1.1/2" BSP**

 EX II 3/3 GD h IIB T4 135 °C ATEX zone2

ARTICLE	CASING	DIAPHRAGM	BALLS	GASKET	FLUIDS
<b>028-P400-AB1</b>	POLYPROPYLENE	HYTREL	SS AISI 316	NBR	oil-exhausted oil-diesel fuel
<b>028-P400-AB2</b>	POLYPROPYLENE	HYTREL+PTFE	PTFE	VITON	water-anti-freeze-windscreen-urea-AdBlue
<b>028-P400-AB3</b>	POLYPROPYLENE	HYTREL+PTFE	PTFE	PTFE	aggressive fluids (acids and basics)
<b>028-P400-AB4</b>	POLIPROPYLENE	SANTOPRENE	EPDM	EPDM	abrasive liquids - alkaline/basic

### Technical data

Fluid connections:	<b>1.1/2" BSP</b>
Air connection:	<b>1/2" BSP</b>
Max flow-rate:	<b>400 l/min</b>
Max air pressure:	<b>8 bar</b>
Max delivery head:	<b>80 m</b>
Max Suction Lift Dry:	<b>5,0 m</b>
Max Suction Lift Wet:	<b>9,8 m</b>
Max Solid passing:	<b>8 mm</b>
Noise level:	<b>78 dB</b>
Displacement per cycle:	<b>1200 cm<sup>3</sup></b>
Max Viscosity:	<b>40000 cps</b>

### Performance

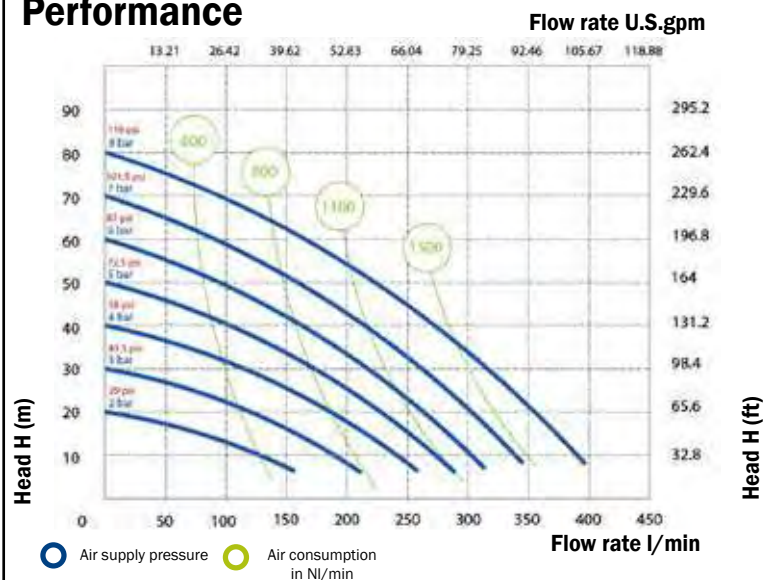

 Air supply pressure  Air consumption in NI/min

The curves and performance values refer to pumps with submerged suction and a free delivery outlet with water at 20 °C, and vary according to the construction material.

### Dimensions

#### P400

A (mm)	454
B (mm)	260
C (mm)	564
Gross weight kg	19,96
MAX Temperature	-4 °C + 65 °C

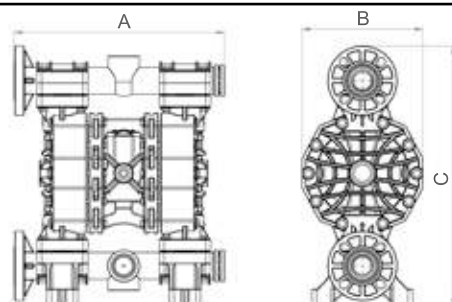

## Meclube Model P700

Made of POLYPROPYLENE

Compression ratio: **1:1**  
 Max flow-rate: **700 l/min**  
 Fluid connections: **2" BSP**



EX II 3/3 GD h IIB T4 135°C ATEX zone2

ARTICLE	CASING	DIAPHRAGM	BALLS	GASKET	FLUIDS
<b>028-P700-AB1</b>	POLYPROPYLENE	HYTREL	SS AISI 316	NBR	oil-exhausted oil-diesel fuel
<b>028-P700-AB2</b>	POLYPROPYLENE	HYTREL+PTFE	PTFE	VITON	water-anti-freeze-windscreen-urea-AdBlue
<b>028-P700-AB3</b>	POLYPROPYLENE	HYTREL+PTFE	PTFE	PTFE	aggressive fluids (acids and basics)
<b>028-P700-AB4</b>	POLIPROPILENE	SANTOPRENE	EPDM	EPDM	abrasive liquids - alkaline/basic

### Performance

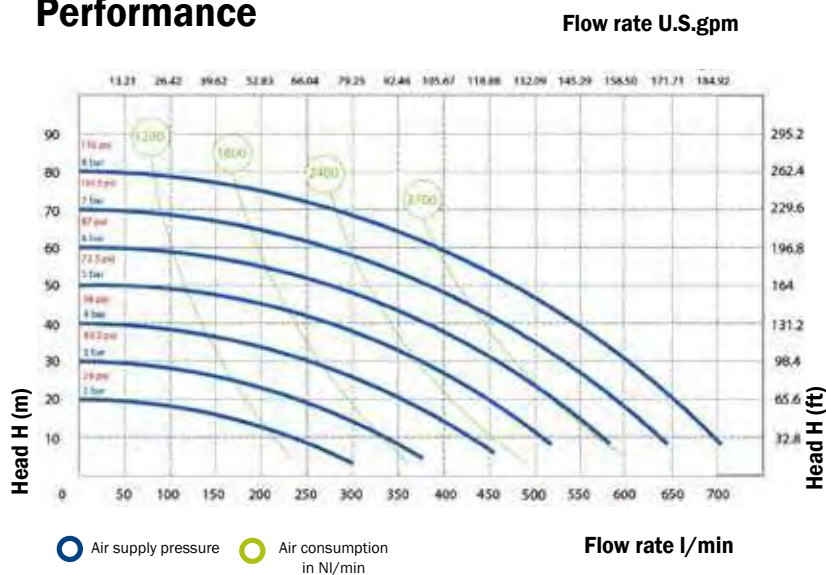

The curves and performance values refer to pumps with submerged suction and a free delivery outlet with water at 20°C, and vary according to the construction material.

### Technical data

Fluid connections:	<b>2" BSP</b>
Air connection:	<b>3/4" BSP</b>
Max flow-rate:	<b>700 l/min</b>
Max air pressure:	<b>8 bar</b>
Max delivery head:	<b>80 m</b>
Max Suction Lift Dry:	<b>5,0 m</b>
Max Suction Lift Wet:	<b>9,8 m</b>
Max Solid passing:	<b>8,5 mm</b>
Noise level:	<b>78 dB</b>
Displacement per cycle:	<b>3050 cm<sup>3</sup></b>
Max Viscosity:	<b>50000 cps</b>

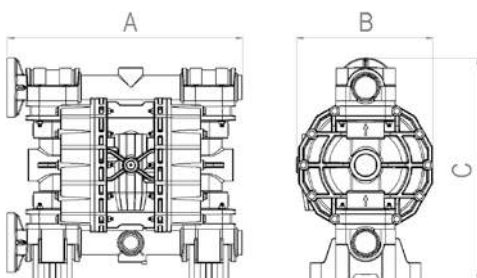

### Dimensions

#### P700

A (mm)	595
B (mm)	345
C (mm)	570
Gross weight kg	37,53
MAX Temperature	-4°C + 65°C



## Meclube Model A35

Made of ALUMINIUM

Compression ratio: 1:1

Max flow-rate: 35 l/min

Fluid connections: 1/2" BSP

 EX II 3/3 GD h IIB T4 135 °C ATEX zone2

ARTICLE	CASING	DIAPHRAGM	BALLS	GASKET	FLUIDS
028-A035-AB1	ALUMINIUM	HYTREL	SS AISI 316	NBR	oil-exhausted oil-diesel fuel
028-A035-AB2	ALUMINIUM	HYTREL+PTFE	PTFE	VITON	water-anti-freeze-windscreen
028-A035-AB3	ALUMINIUM	HYTREL+PTFE	PTFE	PTFE	aggressive fluids (acids and basics)
028-A035-AB4	ALUMINIUM	SANTOPRENE	EPDM	EPDM	abrasive liquids - alkaline/basic

### Technical data

Fluid connections:	<b>1/2" BSP</b>
Air connection:	<b>6 mm</b>
Max flow-rate:	<b>35 l/min</b>
Max air pressure:	<b>7 bar</b>
Max delivery head:	<b>70 m</b>
Max Suction Lift Dry:	<b>5,0 m</b>
Max Suction Lift Wet:	<b>9,8 m</b>
Max Solid passing:	<b>3 mm</b>
Noise level:	<b>65 dB</b>
Displacement per cycle:	<b>65 cm<sup>3</sup></b>
Max Viscosity:	<b>15000 cps</b>

### Performance

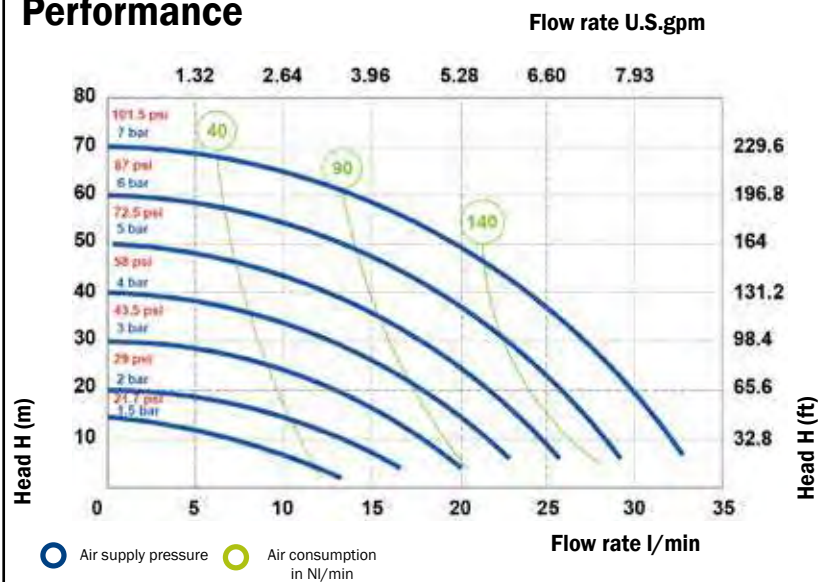

The curves and performance values refer to pumps with submerged suction and a free delivery outlet with water at 20 °C, and vary according to the construction material.

### Dimensions

#### A35

A (mm)	183
B (mm)	110
C (mm)	189
Gross weight kg	3,06
MAX Temperature	-20 °C + 95 °C

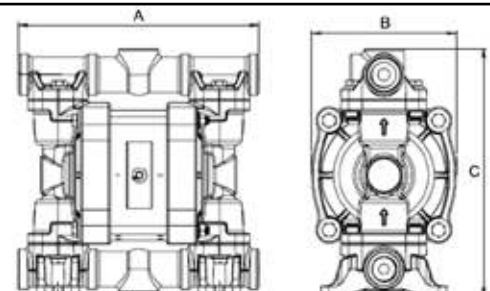

## Meclube Model A55

Made of ALUMINIUM

Compression ratio: 1:1  
 Max flow-rate: 55 l/min  
 Fluid connections: 1/2" BSP



EX II 3/3 GD h IIB T4 135°C ATEX zone2

ARTICLE	CASING	DIAPHRAGM	BALLS	GASKET	FLUIDS
028-A055-AB1	ALUMINIUM	HYTREL	SS AISI 316	NBR	oil-exhausted oil-diesel fuel
028-A055-AB2	ALUMINIUM	HYTREL+PTFE	PTFE	VITON	water-anti-freeze-windscreen
028-A055-AB3	ALUMINIUM	HYTREL+PTFE	PTFE	PTFE	aggressive fluids (acids and basics)
028-A055-AB4	ALUMINIUM	SANTOPRENE	EPDM	EPDM	abrasive liquids - alkaline/basic

### Performance

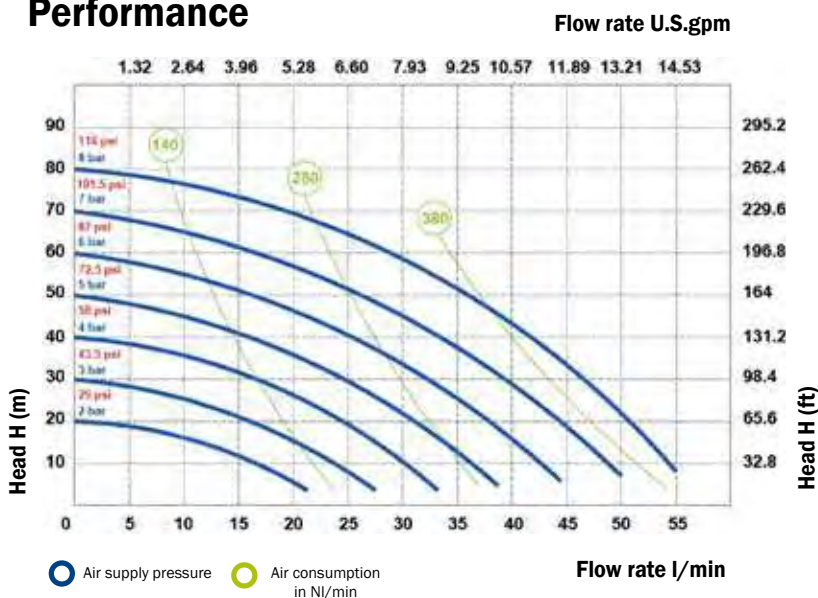

The curves and performance values refer to pumps with submerged suction and a free delivery outlet with water at 20°C, and vary according to the construction material.

### Technical data

Fluid connections: **1/2" BSP**  
 Air connection: **1/4" BSP**  
 Max flow-rate: **55 l/min**  
 Max air pressure: **8 bar**  
 Max delivery head: **80 m**  
 Max Suction Lift Dry: **5,0 m**  
 Max Suction Lift Wet: **9,8 m**  
 Max Solid passing: **3,5 mm**  
 Noise level: **70 dB**  
 Displacement per cycle: **140 cm³**  
 Max Viscosity: **20000 cps**

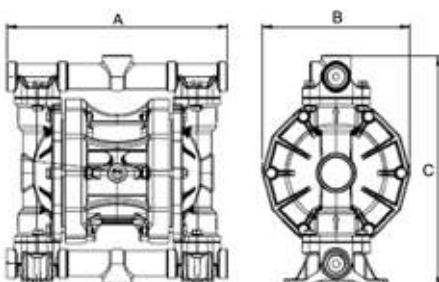

### Dimensions

A55	
A (mm)	234
B (mm)	156
C (mm)	245
Gross weight kg	4,61
MAX Temperature	-20°C + 95°C



# AIR-OPERATED DOUBLE DIAPHRAGM PUMPS



## Meclube Model A110

Made of ALUMINIUM

Compression ratio: 1:1

Max flow-rate: 110 l/min

Fluid connections: 3/4" BSP

EX II 3/3 GD h IIB T4 135 °C ATEX zone2

ARTICLE	CASING	DIAPHRAGM	BALLS	GASKET	FLUIDS
028-A110-AB1	ALUMINIUM	HYTREL	SS AISI 316	NBR	oil-exhausted oil-diesel fuel
028-A110-AB2	ALUMINIUM	HYTREL+PTFE	PTFE	VITON	water-anti-freeze-windscreen
028-A110-AB3	ALUMINIUM	HYTREL+PTFE	PTFE	PTFE	aggressive fluids (acids and basics)
028-A110-AB4	ALUMINIUM	SANTOPRENE	EPDM	EPDM	abrasive liquids - alkaline/basic

### Technical data

Fluid connections:	<b>3/4" BSP</b>
Air connection:	<b>3/8" BSP</b>
Max flow-rate:	<b>100 l/min</b>
Max air pressure:	<b>8 bar</b>
Max delivery head:	<b>80 m</b>
Max Suction Lift Dry:	<b>5,0 m</b>
Max Suction Lift Wet:	<b>9,8 m</b>
Max Solid passing:	<b>4 mm</b>
Noise level:	<b>72 dB</b>
Displacement per cycle:	<b>200 cm<sup>3</sup></b>
Max Viscosity:	<b>25000 cps</b>

### Performance



The curves and performance values refer to pumps with submerged suction and a free delivery outlet with water at 20 °C, and vary according to the construction material.

### Dimensions

#### A110

A (mm)	265
B (mm)	178
C (mm)	245
Gross weight kg	6,0
MAX Temperature	-20 °C + 95 °C

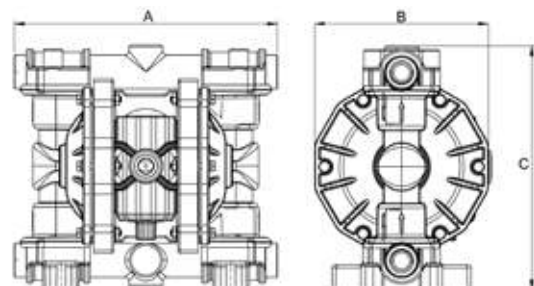

## Meclube Model A170

Made of ALUMINIUM

Compression ratio: **1:1**  
 Max flow-rate: **170 l/min**  
 Fluid connections: **1" BSP**



EX II 3/3 GD h IIB T4 135°C ATEX zone2

ARTICLE	CASING	DIAPHRAGM	BALLS	GASKET	FLUIDS
<b>028-A170-AB1</b>	ALUMINIUM	HYTREL	SS AISI 316	NBR	oil-exhausted oil-diesel fuel
<b>028-A170-AB2</b>	ALUMINIUM	HYTREL+PTFE	PTFE	VITON	water-anti-freeze-windscreen
<b>028-A170-AB3</b>	ALUMINIUM	HYTREL+PTFE	PTFE	PTFE	aggressive fluids (acids and basics)
<b>028-A170-AB4</b>	ALUMINIUM	SANTOPRENE	EPDM	EPDM	abrasive liquids - alkaline/basic

### Performance

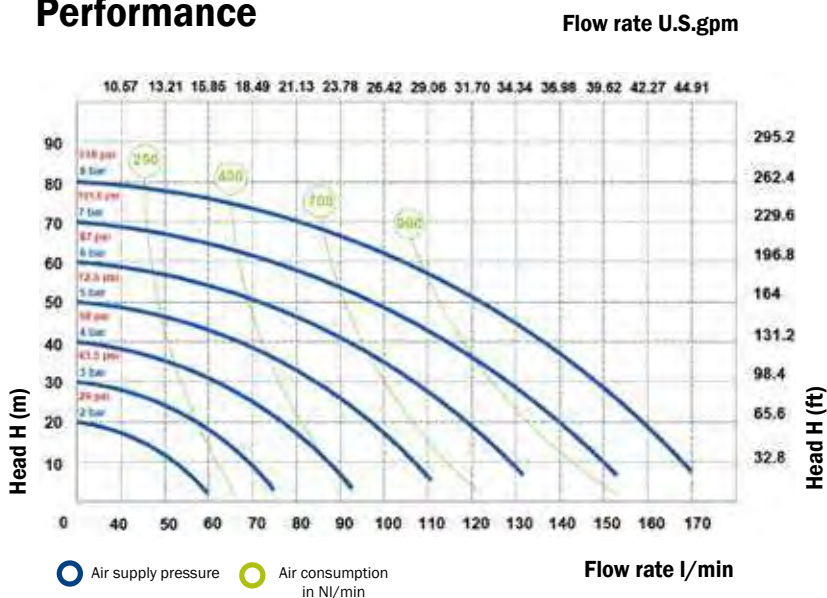

The curves and performance values refer to pumps with submerged suction and a free delivery outlet with water at 20°C, and vary according to the construction material.

### Technical data

- Fluid connections: **1" BSP**
- Air connection: **1/2" BSP**
- Max flow-rate: **170 l/min**
- Max air pressure: **8 bar**
- Max delivery head: **80 m**
- Max Suction Lift Dry: **5,0 m**
- Max Suction Lift Wet: **9,8 m**
- Max Solid passing: **7,5 mm**
- Noise level: **75 dB**
- Displacement per cycle: **700 cm<sup>3</sup>**
- Max Viscosity: **35000 cps**

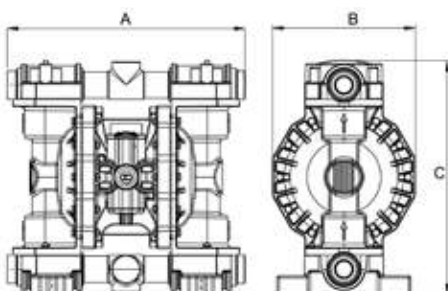

### Dimensions

A170	
A (mm)	370
B (mm)	222
C (mm)	364
Gross weight kg	18,31
MAX Temperature	-20°C + 95°C



## Meclube Model A250

Made of ALUMINIUM

Compression ratio: 1:1

Max flow-rate: 250 l/min

Fluid connections: 1.1/4" BSP

EX II 3/3 GD h IIB T4 135 °C ATEX zone2

ARTICLE	CASING	DIAPHRAGM	BALLS	GASKET	FLUIDS
028-A250-AB1	ALUMINIUM	HYTREL	SS AISI 316	NBR	oil-exhausted oil-diesel fuel
028-A250-AB2	ALUMINIUM	HYTREL+PTFE	PTFE	VITON	water-anti-freeze-windscreen
028-A250-AB3	ALUMINIUM	HYTREL+PTFE	PTFE	PTFE	aggressive fluids (acids and basics)
028-A250-AB4	ALUMINIUM	SANTOPRENE	EPDM	EPDM	abrasive liquids - alkaline/basic

### Technical data

Fluid connections:	<b>1.1/4" BSP</b>
Air connection:	<b>1/2" BSP</b>
Max flow-rate:	<b>250 l/min</b>
Max air pressure:	<b>8 bar</b>
Max delivery head:	<b>80 m</b>
Max Suction Lift Dry:	<b>5,0 m</b>
Max Suction Lift Wet:	<b>9,8 m</b>
Max Solid passing:	<b>7,5 mm</b>
Noise level:	<b>75 dB</b>
Displacement per cycle:	<b>700 cm<sup>3</sup></b>
Max Viscosity:	<b>35000 cps</b>

### Performance



The curves and performance values refer to pumps with submerged suction and a free delivery outlet with water at 20 °C, and vary according to the construction material.

### Dimensions

#### A250

A (mm)	370
B (mm)	222
C (mm)	364
Gross weight kg	13,4
MAX Temperature	-20 °C + 95 °C

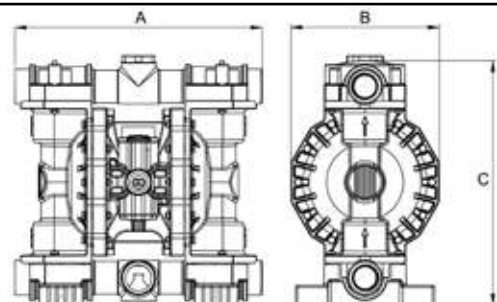

## Meclube Model A400

Made of ALUMINIUM

Compression ratio: 1:1  
 Max flow-rate: 400 l/min  
 Fluid connections: 1.1/2" BSP



EX II 3/3 GD h IIB T4 135°C ATEX zone2

ARTICLE	CASING	DIAPHRAGM	BALLS	GASKET	FLUIDS
028-A400-AB1	ALUMINIUM	HYTREL	SS AISI 316	NBR	oil-exhausted oil-diesel fuel
028-A400-AB2	ALUMINIUM	HYTREL+PTFE	PTFE	VITON	water-anti-freeze-windscreen
028-A400-AB3	ALUMINIUM	HYTREL+PTFE	PTFE	PTFE	aggressive fluids (acids and basics)
028-A400-AB4	ALUMINIUM	SANTOPRENE	EPDM	EPDM	abrasive liquids - alkaline/basic

### Performance



The curves and performance values refer to pumps with submerged suction and a free delivery outlet with water at 20°C, and vary according to the construction material.

### Technical data

Fluid connections: **1.1/2" BSP**  
 Air connection: **1/2" BSP**  
 Max flow-rate: **400 l/min**  
 Max air pressure: **8 bar**  
 Max delivery head: **80 m**  
 Max Suction Lift Dry: **5,0 m**  
 Max Suction Lift Wet: **9,8 m**  
 Max Solid passing: **8 mm**  
 Noise level: **78 dB**  
 Displacement per cycle: **1200 cm<sup>3</sup>**  
 Max Viscosity: **40000 cps**

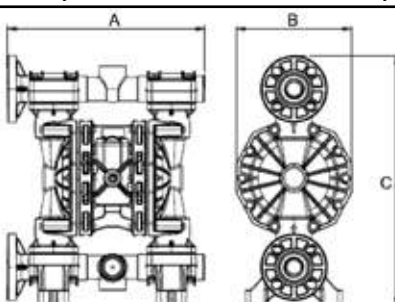

### Dimensions

A400	
A (mm)	445
B (mm)	260
C (mm)	563
Gross weight kg	24,8
MAX Temperature	-20°C + 95°C



## Meclube Model A700

Made of ALUMINIUM

Compression ratio:

1:1

Max flow-rate:

700 l/min

Fluid connections:

2" BSP

 EX II 3/3 GD h IIB T4 135 °C ATEX zone2

ARTICLE	CASING	DIAPHRAGM	BALLS	GASKET	FLUIDS
<b>028-A700-AB1</b>	ALUMINIUM	HYTREL	SS AISI 316	NBR	oil-exhausted oil-diesel fuel
<b>028-A700-AB2</b>	ALUMINIUM	HYTREL+PTFE	PTFE	VITON	water-anti-freeze-windscreen
<b>028-A700-AB3</b>	ALUMINIUM	HYTREL+PTFE	PTFE	PTFE	aggressive fluids (acids and basics)
<b>028-A700-AB4</b>	ALUMINIUM	SANTOPRENE	EPDM	EPDM	abrasive liquids - alkaline/basic

### Technical data

Fluid connections:	<b>2" BSP</b>
Air connection:	<b>3/4" BSP</b>
Max flow-rate:	<b>700 l/min</b>
Max air pressure:	<b>8 bar</b>
Max delivery head:	<b>80 m</b>
Max Suction Lift Dry:	<b>5,0 m</b>
Max Suction Lift Wet:	<b>9,8 m</b>
Max Solid passing:	<b>8,5 mm</b>
Noise level:	<b>78 dB</b>
Displacement per cycle:	<b>3050 cm<sup>3</sup></b>
Max Viscosity:	<b>50000 cps</b>

### Performance

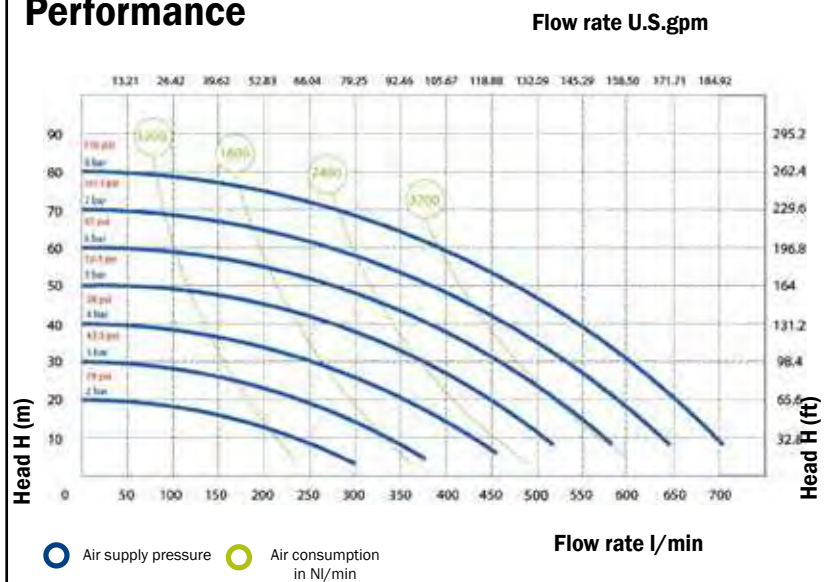

The curves and performance values refer to pumps with submerged suction and a free delivery outlet with water at 20 °C, and vary according to the construction material.

### Dimensions

#### A700

A (mm)	595
B (mm)	345
C (mm)	567
Gross weight kg	41,73
MAX Temperature	-20 °C + 95 °C

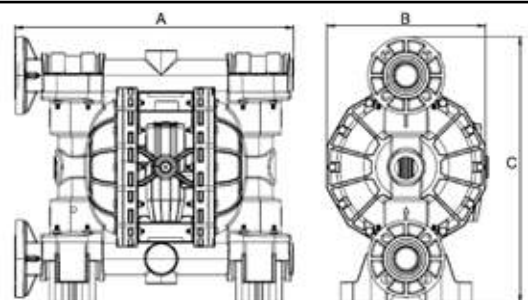

## Meclube Model A1050

Made of ALUMINIUM

Compression ratio: 1:1  
 Max flow-rate: 1050 l/min  
 Fluid connections: 3" BSP



EX II 3/3 GD h IIB T4 135°C ATEX zone2

ARTICLE	CASING	DIAPHRAGM	BALLS	GASKET	FLUIDS
028-A1050-AB1	ALUMINIUM	HYTREL+PTFE	SS AISI 316	PTFE	oil-exhausted oil-diesel fuel
028-A1050-AB3	ALUMINIUM	HYTREL+PTFE	PTFE	PTFE	water-anti-freeze-windscreen (acids and basics)

### Performance

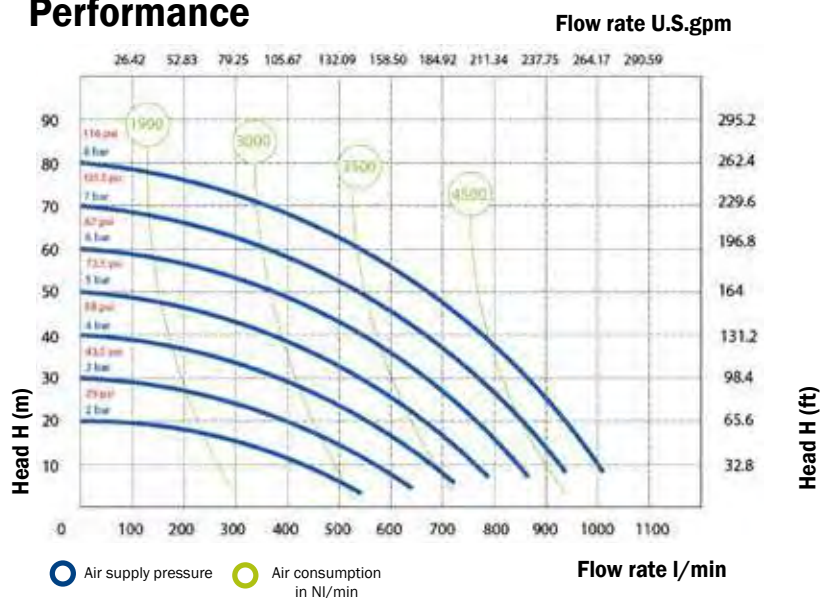

The curves and performance values refer to pumps with submerged suction and a free delivery outlet with water at 20°C, and vary according to the construction material.

### Technical data

Fluid connections: **3" BSP**  
 Air connection: **3/4" BSP**  
 Max flow-rate: **1050 l/min**  
 Max air pressure: **8 bar**  
 Max delivery head: **80 m**  
 Max Suction Lift Dry: **5,0 m**  
 Max Suction Lift Wet: **9,8 m**  
 Max Solid passing: **12 mm**  
 Noise level: **82 dB**  
 Displacement per cycle: **9750 cm<sup>3</sup>**  
 Max Viscosity: **55000 cps**

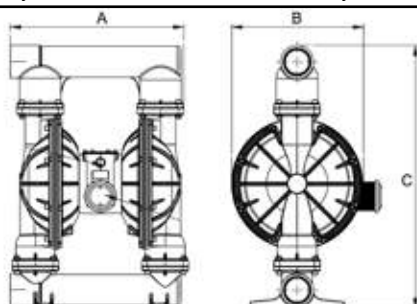

### Dimensions

#### A1050

A (mm) 570  
 B (mm) 420  
 C (mm) 838  
 Gross weight kg 69,6  
 MAX Temperature -20°C + 95°C



## Meclube Model SS20

Made of STAINLESS STEEL AISI 316

Compression ratio: 1:1

Max flow-rate: 20 l/min

Fluid connections: 3/8" BSP

 EX II 3/3 GD h IIB T4 135 °C ATEX zone2

ARTICLE	CASING	DIAPHRAGM	BALLS	GASKET	FLUIDS
<b>028-S020-AB1</b>	SS AISI 316	NBR+PTFE	SS AISI 316	NBR	oil-exhausted oil-diesel fuel
<b>028-S020-AB2</b>	SS AISI 316	NBR+PTFE	PTFE	VITON	water-anti-freeze-windscreen-urea-AdBlue
<b>028-S020-AB3</b>	SS AISI 316	NBR+PTFE	PTFE	PTFE	aggressive fluids (acids and basics)

### Technical data

Fluid connections:	<b>3/8" BSP</b>
Air connection:	<b>6 mm</b>
Max flow-rate:	<b>20 l/min</b>
Max air pressure:	<b>7 bar</b>
Max delivery head:	<b>70 m</b>
Max Suction Lift Dry:	<b>5,0 m</b>
Max Suction Lift Wet:	<b>9,8 m</b>
Max Solid passing:	<b>2,5 mm</b>
Noise level:	<b>65 dB</b>
Displacement per cycle:	<b>30 cm<sup>3</sup></b>
Max Viscosity:	<b>10000 cps</b>

### Performance

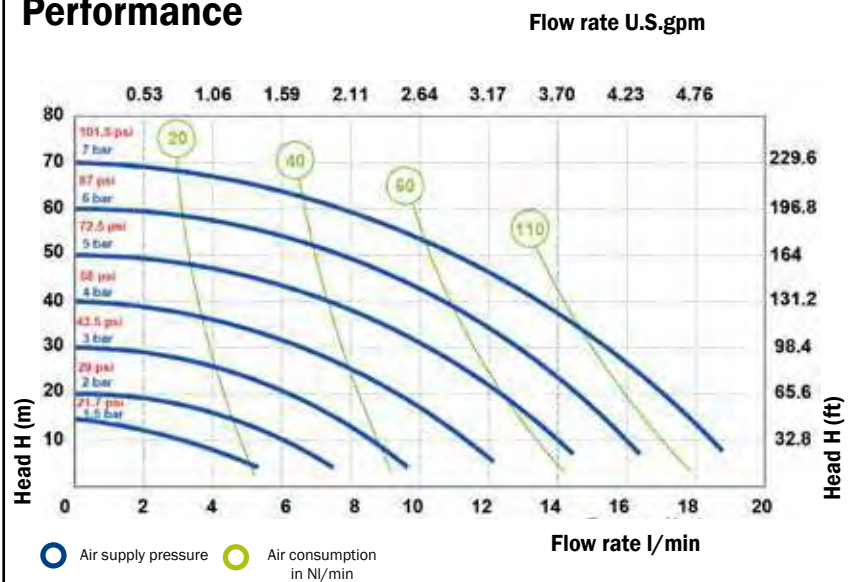

The curves and performance values refer to pumps with submerged suction and a free delivery outlet with water at 20 °C, and vary according to the construction material.

### Dimensions

#### SS20

A (mm)	148
B (mm)	92
C (mm)	152
Gross weight kg	2,49
MAX Temperature	-20 °C + 95 °C

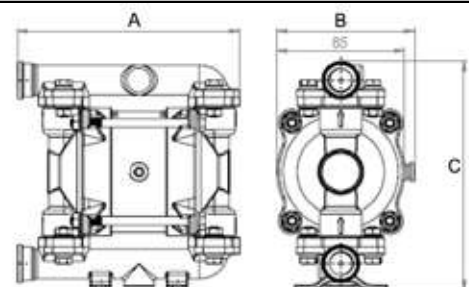

## Meclube Model SS35

Made of STAINLESS STEEL AISI 316

Compression ratio: 1:1  
 Max flow-rate: 35 l/min  
 Fluid connections: 1/2" BSP



EX II 3/3 GD h IIB T4 135°C ATEX zone2

ARTICLE	CASING	DIAPHRAGM	BALLS	GASKET	FLUIDS
028-S035-AB1	SS AISI 316	HYTREL+PTFE	SS AISI 316	NBR	oil-exhausted oil-diesel fuel
028-S035-AB2	SS AISI 316	HYTREL+PTFE	PTFE	VITON	water-anti-freeze-windscreen-urea-AdBlue
028-S035-AB3	SS AISI 316	HYTREL+PTFE	PTFE	PTFE	aggressive fluids (acids and basics)
028-S035-AB4	SS AISI 316	HYTREL+PTFE	EPDM	EPDM	abrasive liquids - alkaline/basic

### Performance

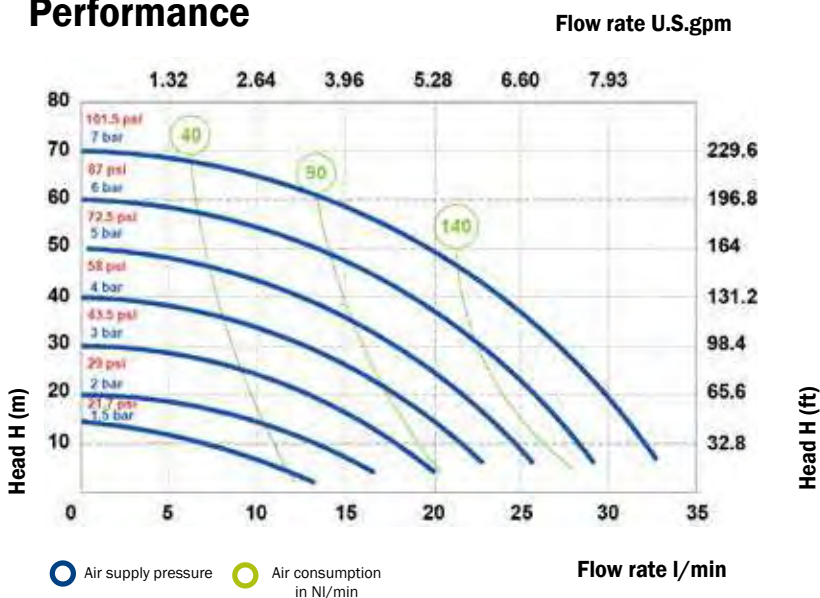

The curves and performance values refer to pumps with submerged suction and a free delivery outlet with water at 20°C, and vary according to the construction material.

### Technical data

Fluid connections:	<b>1/2" BSP</b>
Air connection:	<b>6 mm</b>
Max flow-rate:	<b>35 l/min</b>
Max air pressure:	<b>7 bar</b>
Max delivery head:	<b>70 m</b>
Max Suction Lift Dry:	<b>5,0 m</b>
Max Suction Lift Wet:	<b>9,8 m</b>
Max Solid passing:	<b>3 mm</b>
Noise level:	<b>65 dB</b>
Displacement per cycle:	<b>65 cm<sup>3</sup></b>
Max Viscosity:	<b>15000 cps</b>

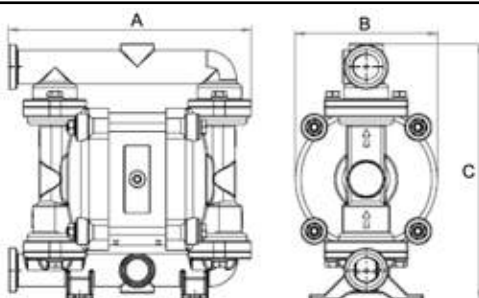

### Dimensions

#### SS35

A (mm)	181
B (mm)	106
C (mm)	192
Gross weight kg	4,38
MAX Temperature	-20°C + 95°C



## Meclube Model SS55

Made of STAINLESS STEEL AISI 316

Compression ratio: 1:1

Max flow-rate: 55 l/min

Fluid connections: 1/2" BSP

 EX II 3/3 GD h IIB T4 135 °C ATEX zone2

ARTICLE	CASING	DIAPHRAGM	BALLS	GASKET	FLUIDS
<b>028-S055-AB1</b>	SS AISI 316	HYTREL+PTFE	SS AISI 316	NBR	oil-exhausted oil-diesel fuel
<b>028-S055-AB2</b>	SS AISI 316	HYTREL+PTFE	PTFE	VITON	water-anti-freeze-windscreen-urea-AdBlue
<b>028-S055-AB3</b>	SS AISI 316	HYTREL+PTFE	PTFE	PTFE	aggressive fluids (acids and basics)
<b>028-S055-AB4</b>	SS AISI 316	HYTREL+PTFE	EPDM	EPDM	abrasive liquids - alkaline/basic

### Technical data

Fluid connections:	<b>1/2" BSP</b>
Air connection:	<b>1/4" BSP</b>
Max flow-rate:	<b>55 l/min</b>
Max air pressure:	<b>8 bar</b>
Max delivery head:	<b>80 m</b>
Max Suction Lift Dry:	<b>5,0 m</b>
Max Suction Lift Wet:	<b>9,8 m</b>
Max Solid passing:	<b>3,5 mm</b>
Noise level:	<b>70 dB</b>
Displacement per cycle:	<b>140 cm<sup>3</sup></b>
Max Viscosity:	<b>20000 cps</b>

### Performance



The curves and performance values refer to pumps with submerged suction and a free delivery outlet with water at 20 °C, and vary according to the construction material.

### Dimensions

#### SS55

A (mm)	234
B (mm)	156
C (mm)	268
Gross weight kg	7,63
MAX Temperature	-20 °C + 95 °C

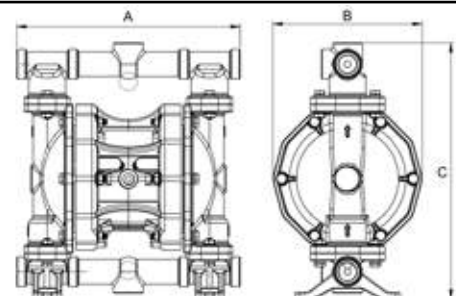

## Meclube Model SS110

Made of STAINLESS STEEL AISI 316

Compression ratio: 1:1

Max flow-rate: 110 l/min

Fluid connections: 3/4" BSP



EX II 3/3 GD h IIB T4 135°C ATEX zone2

ARTICLE	CASING	DIAPHRAGM	BALLS	GASKET	FLUIDS
028-S110-AB1	SS AISI 316	HYTREL+PTFE	SS AISI 316	NBR	oil-exhausted oil-diesel fuel
028-S110-AB2	SS AISI 316	HYTREL+PTFE	PTFE	VITON	water-anti-freeze-windscreen-urea-AdBlue
028-S110-AB3	SS AISI 316	HYTREL+PTFE	PTFE	PTFE	aggressive fluids (acids and basics)
028-S110-AB4	SS AISI 316	HYTREL+PTFE	EPDM	EPDM	abrasive liquids - alkaline/basic

### Performance

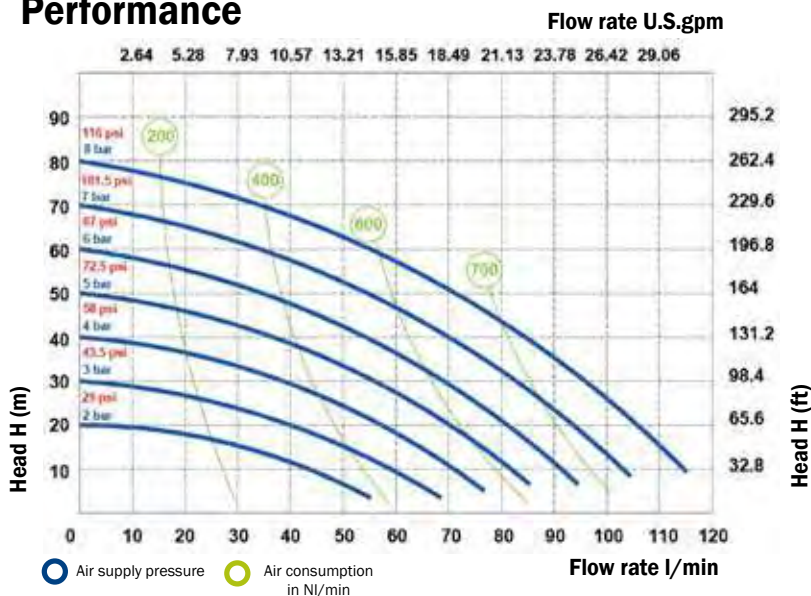

The curves and performance values refer to pumps with submerged suction and a free delivery outlet with water at 20°C, and vary according to the construction material.

### Technical data

Fluid connections:	<b>3/4" BSP</b>
Air connection:	<b>3/8" BSP</b>
Max flow-rate:	<b>110 l/min</b>
Max air pressure:	<b>8 bar</b>
Max delivery head:	<b>80 m</b>
Max Suction Lift Dry:	<b>5,0 m</b>
Max Suction Lift Wet:	<b>9,8 m</b>
Max Solid passing:	<b>4 mm</b>
Noise level:	<b>72 dB</b>
Displacement per cycle:	<b>200 cm<sup>3</sup></b>
Max Viscosity:	<b>25000 cps</b>

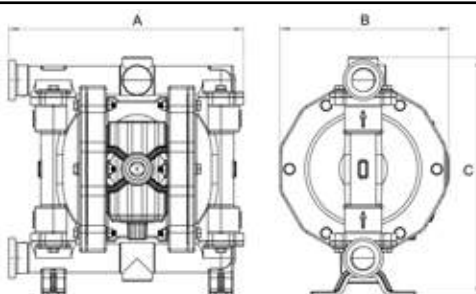

### Dimensions

#### SS110

A (mm)	280
B (mm)	178
C (mm)	291
Gross weight kg	9,2
MAX Temperature	-20°C + 95°C



## Meclube Model SS170

Made of STAINLESS STEEL AISI 316

Compression ratio: 1:1

Max flow-rate: 170 l/min

Fluid connections: 1" BSP

 EX II 3/3 GD h IIB T4 135 °C ATEX zone2

ARTICLE	CASING	DIAPHRAGM	BALLS	GASKET	FLUIDS
<b>028-S170-AB1</b>	SS AISI 316	HYTREL+PTFE	SS AISI 316	NBR	oil-exhausted oil-diesel fuel
<b>028-S170-AB2</b>	SS AISI 316	HYTREL+PTFE	PTFE	VITON	water-anti-freeze-windscreen-urea-AdBlue
<b>028-S170-AB3</b>	SS AISI 316	HYTREL+PTFE	PTFE	PTFE	aggressive fluids (acids and basics)
<b>028-S170-AB4</b>	SS AISI 316	HYTREL+PTFE	EPDM	EPDM	abrasive liquids - alkaline/basic

### Technical data

Fluid connections:	<b>1" BSP</b>
Air connection:	<b>1/2" BSP</b>
Max flow-rate:	<b>170 l/min</b>
Max air pressure:	<b>8 bar</b>
Max delivery head:	<b>80 m</b>
Max Suction Lift Dry:	<b>5,0 m</b>
Max Suction Lift Wet:	<b>9,8 m</b>
Max Solid passing:	<b>7,5 mm</b>
Noise level:	<b>75 dB</b>
Displacement per cycle:	<b>700 cm<sup>3</sup></b>
Max Viscosity:	<b>35000 cps</b>

### Performance



The curves and performance values refer to pumps with submerged suction and a free delivery outlet with water at 20 °C, and vary according to the construction material.

### Dimensions

#### SS170

A (mm)	357
B (mm)	222
C (mm)	371
Gross weight kg	17,88
MAX Temperature	-20 °C + 95 °C

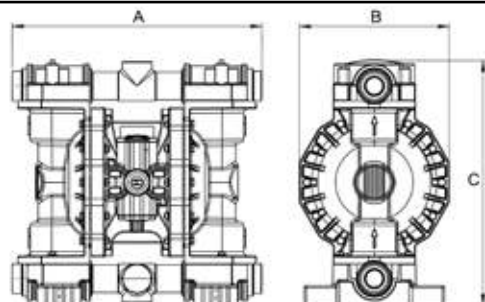

## Meclube Model SS250

Made of STAINLESS STEEL AISI 316

Compression ratio: 1:1

Max flow-rate: 250 l/min

Fluid connections: 1.1/4" BSP



EX II 3/3 GD h IIB T4 135°C ATEX zone2

ARTICLE	CASING	DIAPHRAGM	BALLS	GASKET	FLUIDS
028-S250-AB1	SS AISI 316	HYTREL+PTFE	SS AISI 316	NBR	oil-exhausted oil-diesel fuel
028-S250-AB2	SS AISI 316	HYTREL+PTFE	PTFE	VITON	water-anti-freeze-windscreen-urea-AdBlue
028-S250-AB3	SS AISI 316	HYTREL+PTFE	PTFE	PTFE	aggressive fluids (acids and basics)
028-S250-AB4	SS AISI 316	HYTREL+PTFE	EPDM	EPDM	abrasive liquids - alkaline/basic

### Performance

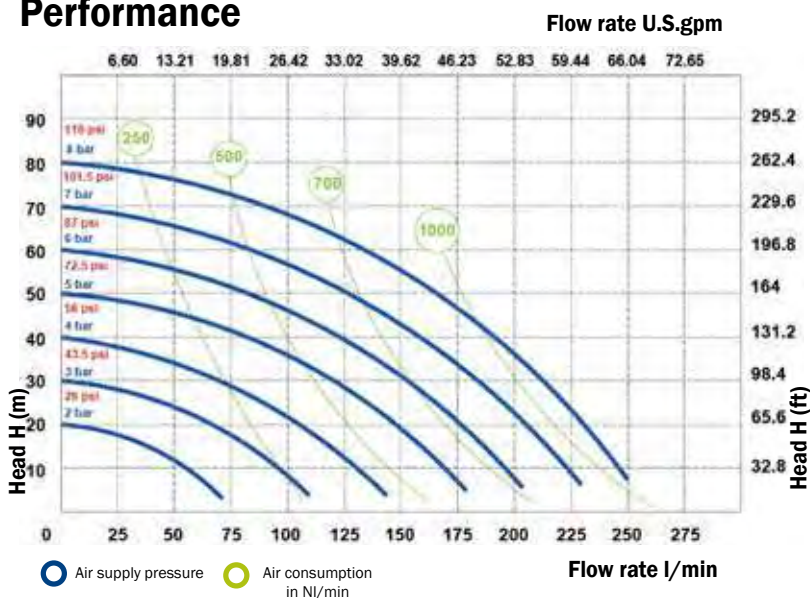

The curves and performance values refer to pumps with submerged suction and a free delivery outlet with water at 20°C, and vary according to the construction material.

### Technical data

Fluid connections:	<b>1.1/4" BSP</b>
Air connection:	<b>1/2" BSP</b>
Max flow-rate:	<b>250 l/min</b>
Max air pressure:	<b>8 bar</b>
Max delivery head:	<b>80 m</b>
Max Suction Lift Dry:	<b>5,0 m</b>
Max Suction Lift Wet:	<b>9,8 m</b>
Max Solid passing:	<b>7,5 mm</b>
Noise level:	<b>75 dB</b>
Displacement per cycle:	<b>700 cm<sup>3</sup></b>
Max Viscosity:	<b>35000 cps</b>

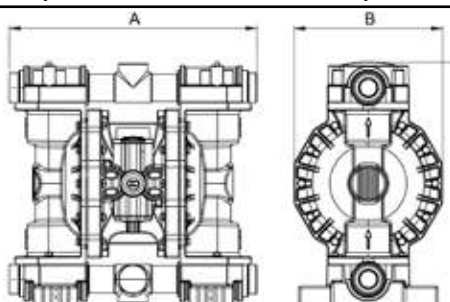

### Dimensions

#### SS250

A (mm)	357
B (mm)	222
C (mm)	371
Gross weight kg	18,39
MAX Temperature	-20°C + 95°C



## Meclube Model SS400

Made of STAINLESS STEEL AISI 316

Compression ratio: 1:1

Max flow-rate: 400 l/min

Fluid connections: 1.1/2" BSP

 EX II 3/3 GD h IIB T4 135 °C ATEX zone2

ARTICLE	CASING	DIAPHRAGM	BALLS	GASKET	FLUIDS
<b>028-S400-EF1</b>	SS AISI 316	HYTREL+PTFE	SS AISI 316	NBR	oil-exhausted oil-diesel fuel
<b>028-S400-EF2</b>	SS AISI 316	HYTREL+PTFE	PTFE	VITON	water-anti-freeze-windscreen-urea-AdBlue
<b>028-S400-EF3</b>	SS AISI 316	HYTREL+PTFE	PTFE	PTFE	aggressive fluids (acids and basics)
<b>028-S400-EF4</b>	SS AISI 316	HYTREL+PTFE	EPDM	EPDM	abrasive liquids - alkaline/basic

### Technical data

Fluid connections:	<b>1.1/2" BSP</b>
Air connection:	<b>1/2" BSP</b>
Max flow-rate:	<b>400 l/min</b>
Max air pressure:	<b>8 bar</b>
Max delivery head:	<b>80 m</b>
Max Suction Lift Dry:	<b>5,0 m</b>
Max Suction Lift Wet:	<b>9,8 m</b>
Max Solid passing:	<b>8 mm</b>
Noise level:	<b>78 dB</b>
Displacement per cycle:	<b>1200 cm<sup>3</sup></b>
Max Viscosity:	<b>40000 cps</b>

### Performance

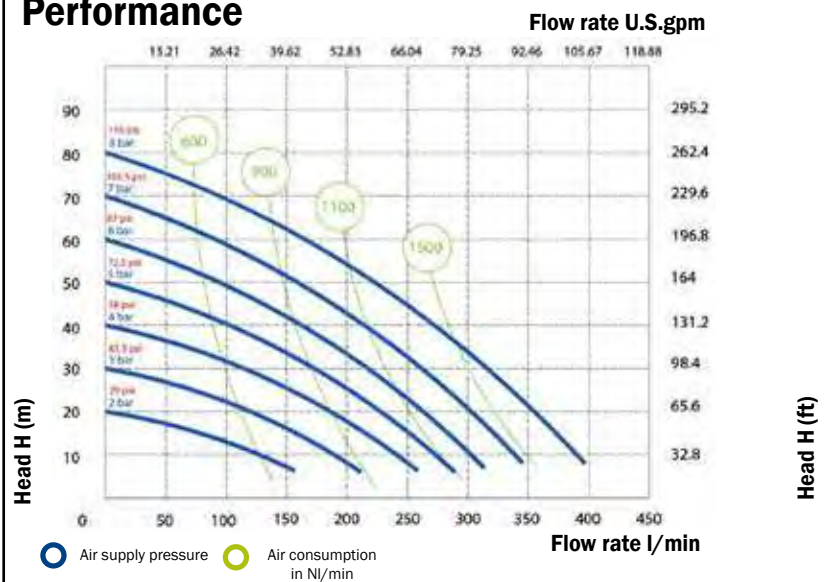

The curves and performance values refer to pumps with submerged suction and a free delivery outlet with water at 20 °C, and vary according to the construction material.

### Dimensions

#### SS400

A (mm)	361
B (mm)	260
C (mm)	502
Gross weight kg	26,3
MAX Temperature	-20 °C + 95 °C

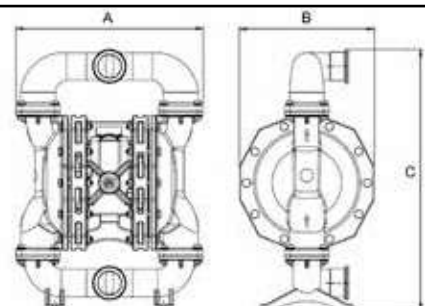

## Meclube Model SS700

Made of STAINLESS STEEL AISI 316

Compression ratio: 1:1  
 Max flow-rate: 700 l/min  
 Fluid connections: 2" BSP



EX II 3/3 GD h IIB T4 135°C ATEX zone2

ARTICLE	CASING	DIAPHRAGM	BALLS	GASKET	FLUIDS
028-S700-EF1	SS AISI 316	HYTREL+PTFE	SS AISI 316	NBR	oil-exhausted oil-diesel fuel
028-S700-EF2	SS AISI 316	HYTREL+PTFE	PTFE	VITON	water-anti-freeze-windscreen-urea-AdBlue
028-S700-EF3	SS AISI 316	HYTREL+PTFE	PTFE	PTFE	aggressive fluids (acids and basics)
028-S700-EF4	SS AISI 316	HYTREL+PTFE	EPDM	EPDM	abrasive liquids - alkaline/basic

### Performance

Flow rate U.S.gpm

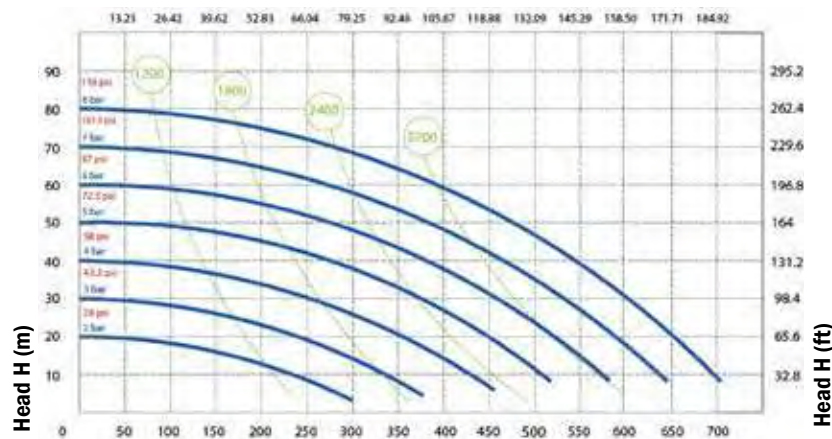

Air supply pressure Air consumption in NI/min

The curves and performance values refer to pumps with submerged suction and a free delivery outlet with water at 20°C, and vary according to the construction material.

### Technical data

Fluid connections: **2" BSP**  
 Air connection: **3/4" BSP**  
 Max flow-rate: **700 l/min**  
 Max air pressure: **8 bar**  
 Max delivery head: **80 m**  
 Max Suction Lift Dry: **5,0 m**  
 Max Suction Lift Wet: **9,8 m**  
 Max Solid passing: **8,5 mm**  
 Noise level: **78 dB**  
 Displacement per cycle: **3050 cm<sup>3</sup>**  
 Max Viscosity: **50000 cps**

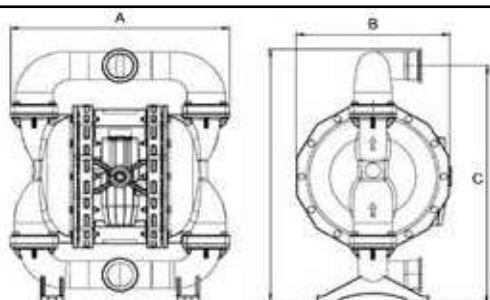

### Dimensions

#### SS700

A (mm) 487  
 B (mm) 345  
 C (mm) 599  
 Gross weight kg 53,8  
 MAX Temperature -20°C + 95°C

Air-operated double diaphragm pumps  
made of **ELECTRO-POLISHED** SS AISI 316  
Flow-rate from 20 l/min to 700 l/min  
Connection from 3/8" to 2"



EX II 3/3 GD h IIB T4 135 °C ATEX zone2

## Meclube Model FOOD SS20

Made of electro-polished  
SS AISI 316

Compression ratio: 1:1  
Max flow-rate: 20 l/min  
Fluid connections: 3/4" Tri-Clamp



EX II 3/3 GD h IIB T4 135°C ATEX zone2

ARTICLE	CASING	DIAPHRAGM	BALLS	GASKET	FLUIDS
028-F020-AB1	SS AISI 316 E-P	HYTREL+PTFE	SS AISI 316	PTFE	high viscosity food products
028-F020-AB2	SS AISI 316 E-P	HYTREL+PTFE	PTFE	PTFE	low viscosity food and drink products

### Performance

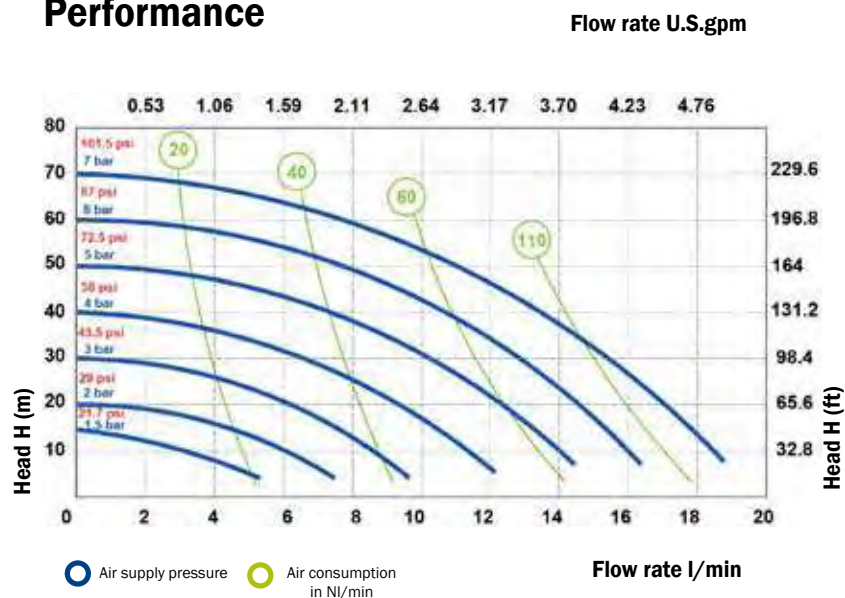

The curves and performance values refer to pumps with submerged suction and a free delivery outlet with water at 20°C, and vary according to the construction material.

### Technical data

Fluid connections: **3/4" Tri-Clamp**  
 Air connection: **6 mm**  
 Max flow-rate: **20 l/min**  
 Max air pressure: **7 bar**  
 Max delivery head: **70 m**  
 Max Suction Lift Dry: **5,0 m**  
 Max Suction Lift Wet: **9,8 m**  
 Max Solid passing: **2,5 mm**  
 Noise level: **65 dB**  
 Displacement per cycle: **30 cm<sup>3</sup>**  
 Max Viscosity: **10000 cps**

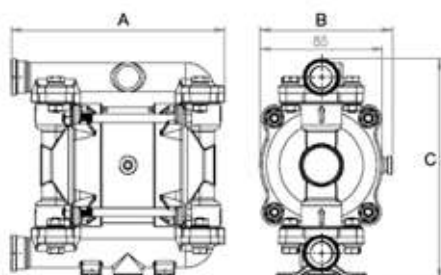

### Dimensions

Food SS20	
A (mm)	148
B (mm)	92
C (mm)	153
Gross weight kg	2,49
MAX Temperature	-20°C + 95°C



## Meclube Model FOOD SS35

Made of electro-polished  
SS AISI 316

Compression ratio: **1:1**  
Max flow-rate: **35 l/min**  
Fluid connections: **1" Tri-Clamp**



 EX II 3/3 GD h IIB T4 135 °C ATEX zone2

ARTICLE	CASING	DIAPHRAGM	BALLS	GASKET	FLUIDS
<b>028-F035-AB1</b>	SS AISI 316 E-P	HYTREL+PTFE	SS AISI 316	PTFE	high viscosity food products
<b>028-F035-AB2</b>	SS AISI 316 E-P	HYTREL+PTFE	PTFE	PTFE	low viscosity food and drink products

### Technical data

Fluid connections:	<b>1" Tri-Clamp</b>
Air connection:	<b>6 mm</b>
Max flow-rate:	<b>35 l/min</b>
Max air pressure:	<b>7 bar</b>
Max delivery head:	<b>70 m</b>
Max Suction Lift Dry:	<b>5 m</b>
Max Suction Lift Wet:	<b>9,8 m</b>
Max Solid passing:	<b>3 mm</b>
Noise level:	<b>65 dB</b>
Displacement per cycle:	<b>65 cm<sup>3</sup></b>
Max Viscosity:	<b>15000 cps</b>

### Performance

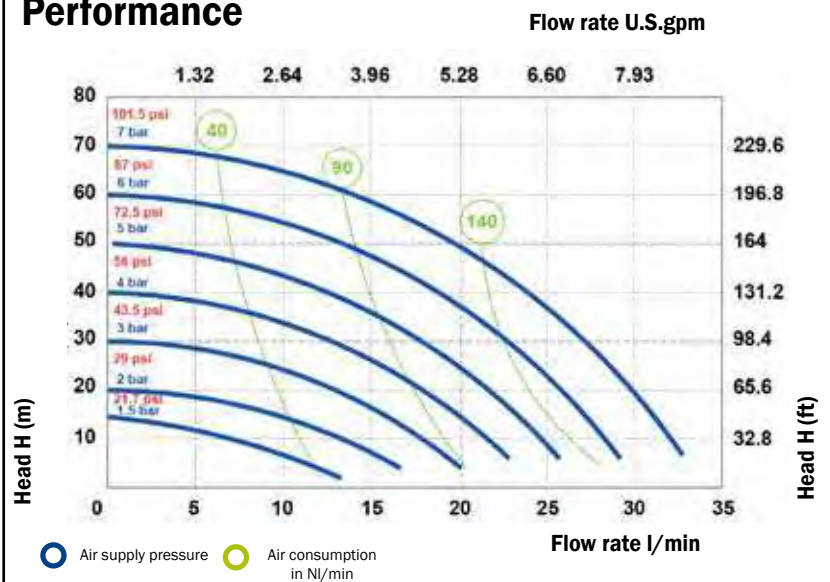

The curves and performance values refer to pumps with submerged suction and a free delivery outlet with water at 20 °C, and vary according to the construction material.

### Dimensions

#### Food SS35

A (mm)	184
B (mm)	106
C (mm)	203
Gross weight kg	4,47
MAX Temperature	-20 °C + 95 °C

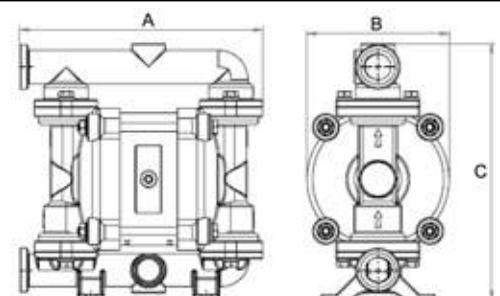

## Meclube Model FOOD SS65

Made of electro-polished  
SS AISI 316

Compression ratio: 1:1  
Max flow-rate: 65 l/min  
Fluid connections: 1" Tri-Clamp



EX II 3/3 GD h IIB T4 135°C ATEX zone2

ARTICLE	CASING	DIAPHRAGM	BALLS	GASKET	FLUIDS
028-F065-AB1	SS AISI 316 E-P	HYTREL+PTFE	SS AISI 316	PTFE	high viscosity food products
028-F065-AB2	SS AISI 316 E-P	HYTREL+PTFE	PTFE	PTFE	low viscosity food and drink products

### Performance

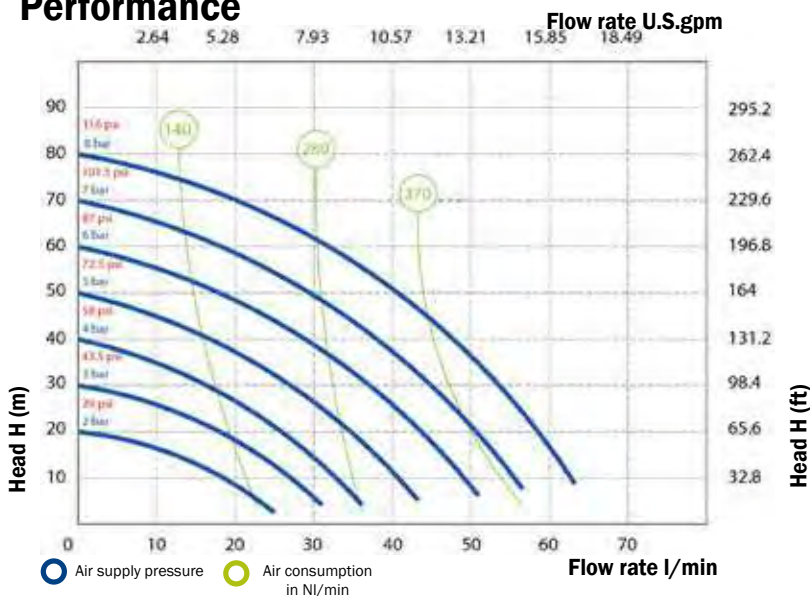

The curves and performance values refer to pumps with submerged suction and a free delivery outlet with water at 20°C, and vary according to the construction material.

### Technical data

Fluid connections:	<b>1" Tri-Clamp</b>
Air connection:	<b>1/4" BSP</b>
Max flow-rate:	<b>65 l/min</b>
Max air pressure:	<b>8 bar</b>
Max delivery head:	<b>80 m</b>
Max Suction Lift Dry:	<b>5,0 m</b>
Max Suction Lift Wet:	<b>9,8 m</b>
Max Solid passing:	<b>3,5 mm</b>
Noise level:	<b>72 dB</b>
Displacement per cycle:	<b>140 cm<sup>3</sup></b>
Max Viscosity:	<b>20000 cps</b>

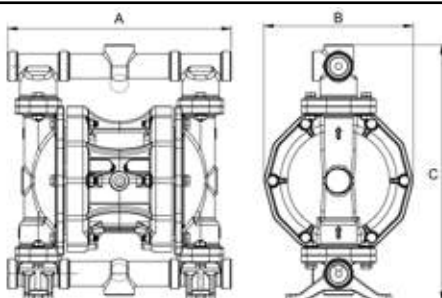

### Dimensions

#### Food SS65

A (mm)	246
B (mm)	165
C (mm)	271
Gross weight kg	8,22
MAX Temperature	-20 °C + 95 °C



## Meclube Model FOOD SS120

Made of electro-polished  
SS AISI 316

Compression ratio: **1:1**  
Max flow-rate: **120 l/min**  
Fluid connections: **1.1/2" Tri-Clamp**



 EX II 3/3 GD h IIB T4 135 °C ATEX zone2

ARTICLE	CASING	DIAPHRAGM	BALLS	GASKET	FLUIDS
<b>028-F120-AB1</b>	SS AISI 316 E-P	NBR+PTFE	SS AISI 316	PTFE	high viscosity food products
<b>028-F120-AB2</b>	SS AISI 316 E-P	NBR+PTFE	PTFE	PTFE	low viscosity food and drink products

### Technical data

Fluid connections:	<b>1.1/2" Tri-Clamp</b>
Air connection:	<b>3/8" BSP</b>
Max flow-rate:	<b>120 l/min</b>
Max air pressure:	<b>8 bar</b>
Max delivery head:	<b>80 m</b>
Max Suction Lift Dry:	<b>5 m</b>
Max Suction Lift Wet:	<b>9,8 m</b>
Max Solid passing:	<b>4,0 mm</b>
Noise level:	<b>72 dB</b>
Displacement per cycle:	<b>200 cm<sup>3</sup></b>
Max Viscosity:	<b>25000 cps</b>

### Performance



The curves and performance values refer to pumps with submerged suction and a free delivery outlet with water at 20 °C, and vary according to the construction material.

### Dimensions

#### Food SS120

A (mm)	259
B (mm)	177
C (mm)	296
Gross weight kg	9,53
MAX Temperature	-20 °C + 95 °C

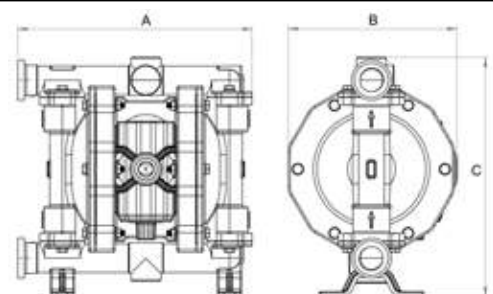

## Meclube Model FOOD SS170

Made of electro-polished  
SS AISI 316

Compression ratio: 1:1  
Max flow-rate: 170 l/min  
Fluid connections: 1.1/2" Tri-Clamp



EX II 3/3 GD h IIB T4 135°C ATEX zone2

ARTICLE	CASING	DIAPHRAGM	BALLS	GASKET	FLUIDS
028-F170-AB1	SS AISI 316 E-P	NBR+PTFE	SS AISI 316	PTFE	high viscosity food products
028-F170-AB2	SS AISI 316 E-P	NBR+PTFE	PTFE	PTFE	low viscosity food and drink products

### Performance

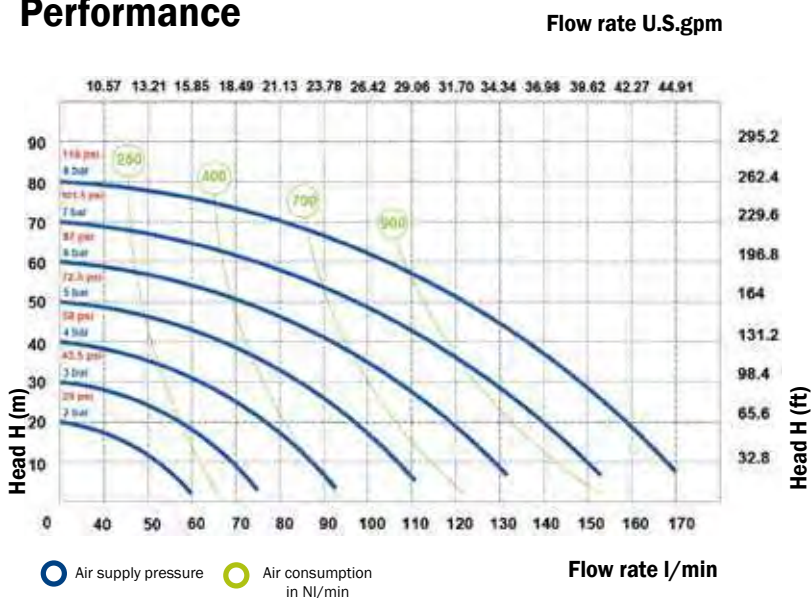

The curves and performance values refer to pumps with submerged suction and a free delivery outlet with water at 20°C, and vary according to the construction material.

### Technical data

Fluid connections: **1.1/2" Tri-Clamp**  
 Air connection: **1/2" BSP**  
 Max flow-rate: **170 l/min**  
 Max air pressure: **8 bar**  
 Max delivery head: **80 m**  
 Max Suction Lift Dry: **5,0 m**  
 Max Suction Lift Wet: **9,8 m**  
 Max Solid passing: **7,5 mm**  
 Noise level: **75 dB**  
 Displacement per cycle: **700 cm³**  
 Max Viscosity: **35000 cps**

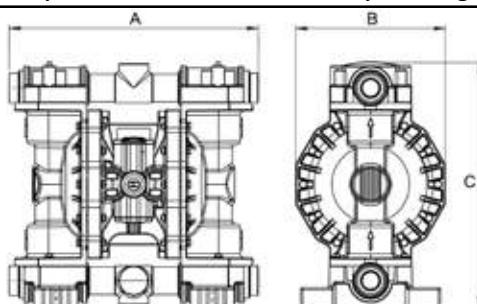

### Dimensions

#### Food SS170

A (mm) 357  
 B (mm) 222  
 C (mm) 371  
 Gross weight kg 17,94  
 MAX Temperature -20°C + 95°C



## Meclube Model FOOD SS400

Made of electro-polished  
SS AISI 316

Compression ratio: 1:1  
Max flow-rate: 400 l/min  
Fluid connections: 2" Tri-Clamp



EX II 3/3 GD h IIB T4 135 °C ATEX zone2

ARTICLE	CASING	DIAPHRAGM	BALLS	GASKET	FLUIDS
<b>028-F400-EF1</b>	SS AISI 316 E-P	NBR+PTFE	SS AISI 316	PTFE	high viscosity food products
<b>028-F400-EF2</b>	SS AISI 316 E-P	NBR+PTFE	PTFE	PTFE	low viscosity food and drink products

### Technical data

Fluid connections:	<b>2" Tri-Clamp</b>
Air connection:	<b>1/2" BSP</b>
Max flow-rate:	<b>400 l/min</b>
Max air pressure:	<b>8 bar</b>
Max delivery head:	<b>80 m</b>
Max Suction Lift Dry:	<b>5,0 m</b>
Max Suction Lift Wet:	<b>9,8 m</b>
Max Solid passing:	<b>8 mm</b>
Noise level:	<b>78 dB</b>
Displacement per cycle:	<b>1200 cm<sup>3</sup></b>
Max Viscosity:	<b>40000 cps</b>

### Performance

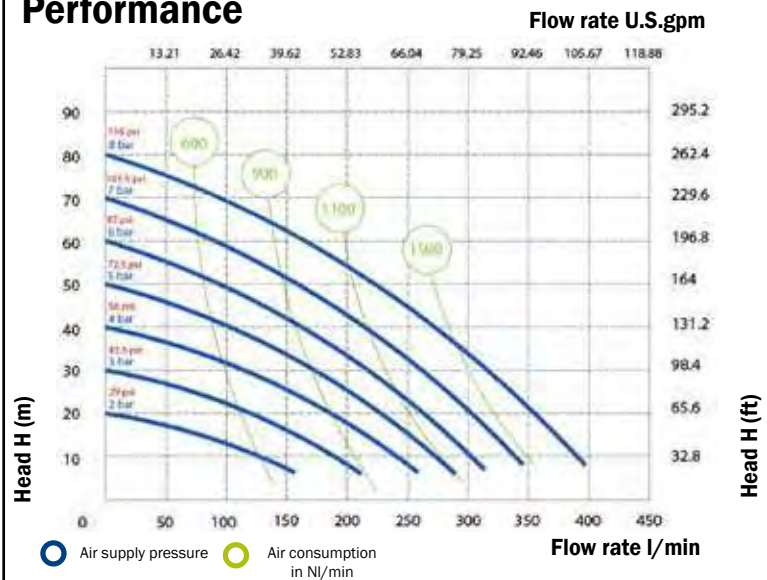

The curves and performance values refer to pumps with submerged suction and a free delivery outlet with water at 20 °C, and vary according to the construction material.

### Dimensions

#### Food SS400

A (mm)	361
B (mm)	260
C (mm)	501,5
Gross weight kg	26,60
MAX Temperature	-20 °C + 95 °C

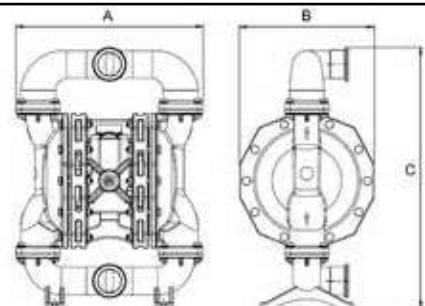

## Meclube Model FOOD SS700

Made of electro-polished  
SS AISI 316

Compression ratio: 1:1  
Max flow-rate: 700 l/min  
Fluid connections: 2.1/2" Tri-Clamp



EX II 3/3 GD h IIB T4 135°C ATEX zone2

**FDA**  
compliant

ARTICLE	CASING	DIAPHRAGM	BALLS	GASKET	FLUIDS
<b>028-F700-EF1</b>	SS AISI 316 E-P	NBR+PTFE	SS AISI 316	PTFE	high viscosity food products
<b>028-F700-EF2</b>	SS AISI 316 E-P	NBR+PTFE	PTFE	PTFE	low viscosity food and drink products

### Performance

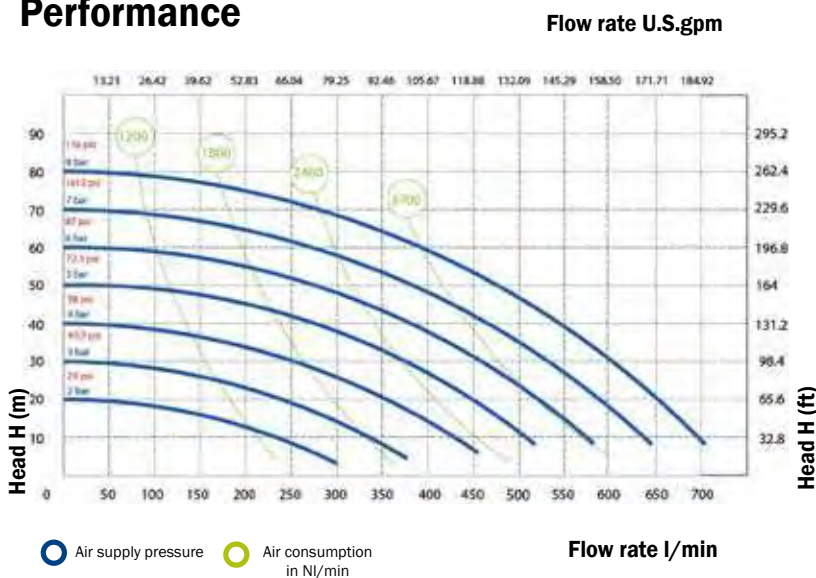

The curves and performance values refer to pumps with submerged suction and a free delivery outlet with water at 20°C, and vary according to the construction material.

### Technical data

Fluid connections: **2.1/2" Tri-Clamp**  
 Air connection: **3/4" BSP**  
 Max flow-rate: **700 l/min**  
 Max air pressure: **8 bar**  
 Max delivery head: **80 m**  
 Max Suction Lift Dry: **5,0 m**  
 Max Suction Lift Wet: **9,8 m**  
 Max Solid passing: **8,5 mm**  
 Noise level: **78 dB**  
 Displacement per cycle: **3050 cm<sup>3</sup>**  
 Max Viscosity: **50000 cps**

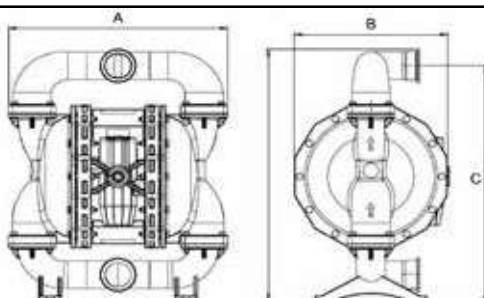

### Dimensions

#### Food SS700

A (mm) 487  
 B (mm) 345  
 C (mm) 598  
 Gross weight kg 53,2  
 MAX Temperature -20°C + 95°C



## DRUM-MEC Model P55TB

Made of POLYPROPYLENE

Compression ratio: 1:1  
 Max flow rate: 55 l/min  
 Fluid connections: 1/2" BSP

### Equipped with:

Suction hose (A28-1264-094) in acetalic resin with threaded ring for fixing to the drum M2" and adaptor M56X4 - F2"

 EX II 3/3 GD h IIB T4 135°C ATEX zone2

ARTICLE	CASING	DIAPHRAGM	BALLS	GASKET	FLUIDS
<b>028-P055-TB1</b>	POLYPROPYLENE	HYTREL	SS AISI 316	NBR	oil-exhausted oil-diesel fuel
<b>028-P055-TB3</b>	POLYPROPYLENE	HYTREL+PTFE	PTFE	PTFE	water-anti-freeze-windscreen-urea-AdBlue



## DRUM-MEC Model P110TB

Made of POLYPROPYLENE

Compression ratio: 1:1  
 Max flow rate: 110 l/min  
 Fluid connections: 3/4" BSP

### Equipped with:

Suction hose (A28-1264-094) in acetalic resin with threaded ring for fixing to the drum M2" and adaptor M56X4 - F2"

 EX II 3/3 GD h IIB T4 135°C ATEX zone2

ARTICLE	CASING	DIAPHRAGM	BALLS	GASKET	FLUIDS
<b>028-P110-TB1</b>	POLYPROPYLENE	HYTREL	SS AISI 316	NBR	oil-exhausted oil-diesel fuel
<b>028-P110-TB3</b>	POLYPROPYLENE	HYTREL+PTFE	PTFE	PTFE	water-anti-freeze-windscreen-urea-AdBlue



TECHNICAL DATA	028-P055-TB1	028-P055-TB3	028-P110-TB1	028-P110-TB3
Fluid connections	1/2" BSP	1/2" BSP	3/4" BSP	3/4" BSP
Air connection	1/4" BSP	1/4" BSP	3/8" BSP	3/8" BSP
Max flow-rate	55 l/min	55 l/min	110 l/min	110 l/min
Max air pressure	8 bar	8 bar	8 bar	8 bar
Max delivery head	80 m	80 m	80 m	80 m
Max Suction Lift Dry	5 m	5 m	5 m	5 m
Max Suction Lift Wet	9,8 m	9,8 m	9,8 m	9,8 m
Max Solid passing	3,5 mm	3,5 mm	4,0 mm	4,0 mm
Noise level	70 dB	70 dB	72 dB	72 dB
Displacement per cycle	140 cm <sup>3</sup>	140 cm <sup>3</sup>	200 cm <sup>3</sup>	200 cm <sup>3</sup>
Max Viscosity	20000 cps	20000 cps	25000 cps	25000 cps

## DRUM-MEC Model A55TB

Made of ALUMINIUM

Compression ratio: 1:1  
 Max flow rate: 55 l/min  
 Fluid connections: 1/2" BSP

### Equipped with:

Suction hose (A28-1274-094) in galvanized steel with brass foot valve, threaded ring for fixing to the drum M2" and adaptor M56X4 - F2"



EX II 3/3 GD h IIB T4 135 °C ATEX zone2

ARTICLE	CASING	DIAPHRAGM	BALLS	GASKET	FLUIDS
<b>028-A055-TB1</b>	ALUMINIUM	HYTREL	SS AISI 316	NBR	oil-exhausted oil-diesel fuel
<b>028-A055-TB3</b>	ALUMINIUM	HYTREL+PTFE	PTFE	PTFE	water-anti-freeze-windscreen

## DRUM-MEC Model A110TB

Made of ALUMINIUM

Compression ratio: 1:1  
 Max flow rate: 110 l/min  
 Fluid connections: 3/4" BSP

### Equipped with:

Suction hose (A28-1274-094) in galvanized steel with brass foot valve, threaded ring for fixing to the drum M2" and adaptor M56X4 - F2"



EX II 3/3 GD h IIB T4 135 °C ATEX zone2

ARTICLE	CASING	DIAPHRAGM	BALLS	GASKET	FLUIDS
<b>028-A110-TB1</b>	ALUMINIUM	HYTREL	SS AISI 316	NBR	oil-exhausted oil-diesel fuel
<b>028-A110-TB3</b>	ALUMINIUM	HYTREL+PTFE	PTFE	PTFE	water-anti-freeze-windscreen

TECHNICAL DATA	028-A055-TB1	028-A055-TB3	028-A110-TB1	028-A110-TB3
Fluid connections	1/2" BSP	1/2" BSP	3/4" BSP	3/4" BSP
Air connection	1/4" BSP	1/4" BSP	3/8" BSP	3/8" BSP
Max flow-rate	55 l/min	55 l/min	110 l/min	110 l/min
Max air pressure	8 bar	8 bar	8 bar	8 bar
Max delivery head	80 m	80 m	80 m	80 m
Max Suction Lift Dry	5 m	5 m	5 m	5 m
Max Suction Lift Wet	9,8 m	9,8 m	9,8 m	9,8 m
Max Solid passing	3,5 mm	3,5 mm	4,0 mm	4,0 mm
Noise level	70 dB	70 dB	72 dB	72 dB
Displacement per cycle	140 cm <sup>3</sup>	140 cm <sup>3</sup>	200 cm <sup>3</sup>	200 cm <sup>3</sup>
Max Viscosity	20000 cps	20000 cps	25000 cps	25000 cps





## TWIN-MEC Model A55TW

Made of ALUMINIUM

Compression ratio: 1:1  
 Max flow rate: 55 l/min  
 Fluid connections: 1/2" BSP

 EX II 3/3 GD h IIB T4 135°C ATEX zone2

ARTICLE	CASING	DIAPHRAGM	BALLS	GASKET	FLUIDS
028-A055-TW1	ALUMINIUM	HYTREL	SS AISI 316	NBR	oil-exhausted oil-diesel fuel
028-A055-TW3	ALUMINIUM	HYTREL+PTFE	PTFE	PTFE	water-anti-freeze-windscreen



## TWIN-MEC Model A110TW

Made of ALUMINIUM

Compression ratio: 1:1  
 Max flow rate: 110 l/min  
 Fluid connections: 3/4" BSP

 EX II 3/3 GD h IIB T4 135°C ATEX zone2

ARTICLE	CASING	DIAPHRAGM	BALLS	GASKET	FLUIDS
028-A110-TW1	ALUMINIUM	HYTREL	SS AISI 316	NBR	oil-exhausted oil-diesel fuel
028-A110-TW3	ALUMINIUM	HYTREL+PTFE	PTFE	PTFE	water-anti-freeze-windscreen

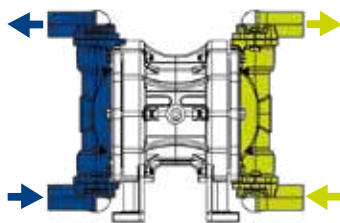

TECHNICAL DATA	028-A055-TW1	028-A055-TW3	028-A110-TW1	028-A110-TW3
Fluid connections	1/2" BSP	1/2" BSP	3/4" BSP	3/4" BSP
Air connection	1/4" BSP	1/4" BSP	3/8" BSP	3/8" BSP
Max flow-rate	55 l/min	55 l/min	110 l/min	110 l/min
Max air pressure	8 bar	8 bar	8 bar	8 bar
Max delivery head	80 m	80 m	80 m	80 m
Max Suction Lift Dry	5 m	5 m	5 m	5 m
Max Suction Lift Wet	9,8 m	9,8 m	9,8 m	9,8 m
Max Solid passing	3,5 mm	3,5 mm	4,0 mm	4,0 mm
Noise level	70 dB	70 dB	72 dB	72 dB
Displacement per cycle	140 cm <sup>3</sup>	140 cm <sup>3</sup>	200 cm <sup>3</sup>	200 cm <sup>3</sup>
Max Viscosity	20000 cps	20000 cps	25000 cps	25000 cps

TWIN-MEC pumps are mainly used in the textile and paper processing industry. These dual action pumps are able to transfer two different fluids independently and simultaneously. This is accomplished by using separate connections on the suction and discharge ports, keeping two pumped fluids isolated from each other, preventing unwanted mixing.

## Pressure regulators with pressure gauge

ARTICLE	THREAD	REGOULATION	FLOW RATE
014-1045-000	F-F 1/4"	0÷8 bar	2050 NI/min
014-1045-B00	F-F 1/2"	0÷8 bar	3200 NI/min
014-1045-C00	F-F 3/4"	0÷8 bar	6200 NI/min
014-1045-D00	F-F 1"	0÷8 bar	6200 NI/min



## Pressure regulators with filter and pressure gauge

ARTICLE	THREAD	REGOULATION	FLOW RATE	FILTRATION
014-1046-000	F-F 1/4"	0÷8 bar	1650 NI/min	20 µ
014-1046-B00	F-F 1/2"	0÷8 bar	3000 NI/min	20 µ
014-1046-C00	F-F 3/4"	0÷8 bar	4500 NI/min	20 µ
014-1046-D00	F-F 1"	0÷8 bar	4500 NI/min	20 µ



## Air lubricator

ARTICLE	THREAD	REGOULATION	FLOW RATE
014-1047-000	F-F 1/4"	-	2600 NI/min
014-1047-B00	F-F 1/2"	-	5600 NI/min
014-1047-C00	F-F 3/4"	-	8200 NI/min
014-1047-D00	F-F 1"	-	8200 NI/min



## Pressure regulators with lubricating filter and pressure gauge

ARTICLE	THREAD	REGOULATION	FLOW RATE	FILTRATION
014-1048-000	F-F 1/4"	0÷8 bar	1100 NI/min	20 µ
014-1048-B00	F-F 1/2"	0÷8 bar	2500 NI/min	20 µ
014-1048-C00	F-F 3/4"	0÷8 bar	4300 NI/min	20 µ
014-1048-D00	F-F 1"	0÷8 bar	4300 NI/min	20 µ



To optimise the performance and the long life of the pneumatic equipment, we suggest to use air without condensation, lubricated and at an adequate pressure.

The active pulsation damper is the most efficient way to remove pressure variations on the discharge of the pump. Meclube pulsation damper works actively with compressed air and a diaphragm, automatically setting the correct pressure to minimize the pulsations. Pulsation dampers require minimum maintenance and are, subject to the requirements of the application, available in the same casing and diaphragm materials as the pump.

## Applications and advantages

- **Metering and dispensing**  
It damps the discharge pressure spikes, increasing accuracy
- **Filter Press**  
It increases filter efficiency and life by providing a smooth flow
- **Spraying**  
Constant spray pattern.
- **Filling**  
It eliminates inconstant filling and splashing.
- **Transfer**  
It eliminates harmful water hammers, preventing pipes and valves damages.



**Significant pulsation reduction with an average percentage of 70% - 80% pulsation reduction in high back pressure applications.**

## How it works

The pulsating flow of the discharge forces the diaphragm upwards where it is cushioned by the air in the chamber. The flexing of the diaphragm absorbs the pulsation giving a constant flow.



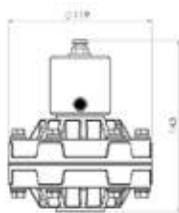

**Model DAMP 35**

Max flow rate: 35 l/min  
 Fluid connections: 3/4" BSP

ARTICLE	CASING	DIAPHRAGM	FLUID CONN.	AIR CONN.	MAX PRESS.	MAX FLOW RATE
A28-0035-001	POLYPROPYLENE	HYTREL+PTFE	3/4" BSP	6 mm	8 bar	35 l/min
A28-0035-002	PVDF+CF	SANTOPRENE+PTFE	3/4" BSP	6 mm	8 bar	35 l/min
A28-0035-003	POMc	HYTREL	3/4" BSP	6 mm	8 bar	35 l/min
A28-0035-004	SS AISI 316	SANTOPRENE	3/4" BSP	6 mm	8 bar	35 l/min

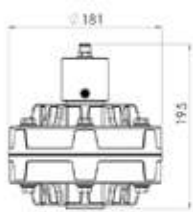

**Model DAMP 110**

Max flow rate: 110 l/min  
 Fluid connections: 1" BSP

ARTICLE	CASING	DIAPHRAGM	FLUID CONN.	AIR CONN.	MAX PRESS.	MAX FLOW RATE
A28-0110-001	POLYPROPYLENE	HYTREL+PTFE	1" BSP	8 mm	8 bar	110 l/min
A28-0110-002	PVDF+CF	SANTOPRENE+PTFE	1" BSP	8 mm	8 bar	110 l/min
A28-0110-003	POMc	HYTREL	1" BSP	8 mm	8 bar	110 l/min
A28-0110-004	SS AISI 316	SANTOPRENE	1" BSP	8 mm	8 bar	110 l/min

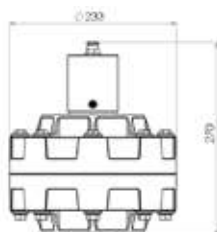

**Model DAMP 250**

Max flow rate: 250 l/min  
 Fluid connections: 1" 1/2 BSP

ARTICLE	CASING	DIAPHRAGM	FLUID CONN.	AIR CONN.	MAX PRESS.	MAX FLOW RATE
A28-0250-001	POLYPROPYLENE	HYTREL+PTFE	1.1/2" BSP	10 mm	8 bar	250 l/min
A28-0250-002	PVDF+CF	SANTOPRENE+PTFE	1.1/2" BSP	10 mm	8 bar	250 l/min
A28-0250-003	POMc	HYTREL	1.1/2" BSP	10 mm	8 bar	250 l/min
A28-0250-004	SS AISI 316	SANTOPRENE	1.1/2" BSP	10 mm	8 bar	250 l/min

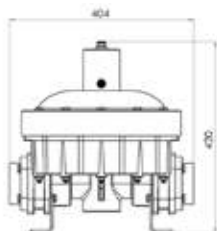

**Model DAMP 1000**

Max flow rate: 1000 l/min  
 Fluid connections: 2" BSP

ARTICLE	CASING	DIAPHRAGM	FLUID CONN.	AIR CONN.	MAX PRESS.	MAX FLOW RATE
A28-1000-001	POLYPROPYLENE	HYTREL+PTFE	2" BSP	12 mm	8 bar	1000 l/min
A28-1000-002	PVDF+CF	SANTOPRENE+PTFE	2" BSP	12 mm	8 bar	1000 l/min
A28-1000-003	ALLUMINIO	HYTREL	2" BSP	12 mm	8 bar	1000 l/min
A28-1000-004	SS AISI 316	SANTOPRENE	2" BSP	12 mm	8 bar	1000 l/min



**Art. 025-1266-001**

**Wall fixing bracket**

For diaphragm pumps **Mod. 20/35/55**



**Art. 025-1266-002**

**Wall fixing bracket**

For diaphragm pumps **Mod. 110/120/170/250**



**Art. 025-1266-003**

**Wall fixing bracket**

For diaphragm pumps **Mod. 400/700**



**Art. A28-3000-001**

**Stainless steel trolley base dimension 330x236 mm**

Nylon wheels Ø 125 with stainless steel plugs

For diaphragm pumps **Mod. 110/120/170/250**



**Art. A28-3000-002**

**Stainless steel trolley base dimension 600x270 mm**

Nylon wheels Ø 125 with stainless steel plugs

For diaphragm pumps **Mod. 400/700**



## FLANGE CONNECTION KIT

Adapt a pump from BSP type connection to flanges with this kit.



ARTICLE	CASING	FLUID CONNECTION	PUMP MODEL
A28-0016-001	POLYPROPYLENE	DN 16 - 1/2"	P20
A28-0016-002	PVDF	DN 16 - 1/2"	PVDF20
A28-0016-003	ALUMINIUM	DN 16 - 1/2"	A20
A28-0016-004	SS AISI 316	DN 16 - 1/2"	SS20

ARTICLE	CASING	FLUID CONNECTION	PUMP MODEL
A28-0025-001	POLYPROPYLENE	DN 25 - 1"	P55 - P110
A28-0025-002	PVDF	DN 25 - 1"	PVDF55 - PVDF110
A28-0025-003	ALUMINIUM	DN 25 - 1"	A55 - A110
A28-0025-004	SS AISI 316	DN 25 - 1"	SS65 - SS120

ARTICLE	CASING	FLUID CONNECTION	PUMP MODEL
A28-0032-001	POLYPROPYLENE	DN 32 - 1.1/4"	P170 - P250
A28-0032-002	PVDF	DN 32 - 1.1/4"	PVDF170 - PVDF250
A28-0032-003	ALUMINIUM	DN 32 - 1.1/4"	A170 - A250
A28-0032-004	SS AISI 316	DN 32 - 1.1/4"	SS170 - SS250

ARTICLE	CASING	FLUID CONNECTION	PUMP MODEL
A28-0050-004	SS AISI 316	DN 50 - 2"	SS400
A28-0065-004	SS AISI 316	DN 65 - 2.1/2"	SS700

## SUCTION HOSE FOR DIAPHRAGM PUMPS

In polypropylene (POMc) with threaded ring connect drum



ARTICLE	SUCTION HOSE	DIMENSION	THREAD	FOOT VALVE	ADAPTOR	THREADED RING
A28-1264-094	POMc	Ø 30X940 mm	M 1/2" BSP	-	M56X4-F2"	M 2" P. Ø 30 mm
A28-1265-094	POMc	Ø 30X940 mm	M 3/4" BSP	-	M56X4-F2"	M 2" P. Ø 30 mm
A28-1264-125	POMc	Ø 30X1250 mm	M 1/2" BSP	-	M56X4-F2"	M 2" P. Ø 30 mm
A28-1265-125	POMc	Ø 30X1250 mm	M 3/4" BSP	-	M56X4-F2"	M 2" P. Ø 30 mm

## SUCTION TUBE FOR DIAPHRAGM PUMPS

In galvanized steel with foot valve and threaded ring connect drum



ARTICLE	SUCTION TUBE	DIMENSION	THREAD	FOOT VALVE	ADAPTOR	THREADED RING
A28-1274-094	GALVANIZED STEEL	Ø 30X940 mm	M 1/2" BSP	BRASS	M56X4-F2"	M 2" P. Ø 30 mm
A28-1275-094	GALVANIZED STEEL	Ø 30X940 mm	M 3/4" BSP	BRASS	M56X4-F2"	M 2" P. Ø 30 mm
A28-1274-125	GALVANIZED STEEL	Ø 30X1250 mm	M 1/2" BSP	BRASS	M56X4-F2"	M 2" P. Ø 30 mm
A28-1275-125	GALVANIZED STEEL	Ø 30X1250 mm	M 3/4" BSP	BRASS	M56X4-F2"	M 2" P. Ø 30 mm

# CHEMICAL COMPATIBILITY TABLE

FLUID	CHEMICAL CODE	MAX CONC.	BEST CONFIGURATION	OTHER ACCEPTABLE MATERIALS	NOTE
ETHYL ACETATE	CH3COOC2H5	ALL	PHTTPD	A	
ACETONE	C3H6O	ALL	PHTTPD	A - S	
ACETIC ACID	C2H4O2	ALL	PHTTPD		
CYANIDE	HCN	ALL	PHTTPV		
HYDROCHLORIC ACID	HCJ	ALL	PHTTPV	KC	
CHROMIC ACID	H2CrO4	ALL	KCMTTKV	Z	
HYDROFLUORIC ACID	HF	ALL	KCMTTKT	PC	NO PP because is with glass fiber
FORMIC ACID	CH2O2	ALL	PHTTPD	A - S - KC	
NITRIC ACID	HN03	20%	PHTTPV	S - KC - Z	
NITRIC ACID	HN03	100%	KCMTTKV	S	
SULPHURIC ACID	H2SO4	50%	PHTTPV	KC	HIGH DENSITY
SULPHURIC ACID	H2SO4	98%	KCMTTKV		HIGH DENSITY
WATER+SAND		ALL	PDDZD	A - N	HIGH ABRASION-NO-CHEMICALS
ALCOHOLS (GENERIC)	CnH2n+2O	ALL	PHTTPD	S	
VINYL GLUE	***	ALL	PHTSSD	A	HIGH VISCOSITY
SODIUM HYDROXIDE	NaOH	ALL	PHTTPD	S	
SODIUM HYPOCHLORITE	NaOCL	15%	PHTTPV		
SODIUM HYPOCHLORITE	NaOCL	100%	KCMTTKV	PC	NO PP because is with glass fiber
ISOCYANATE	***	ALL	PHTSPV	A	HIGH VISCOSITY
MILK OF LIME	***	ALL	PDDZD	D	HIGH ABRASION - ALKALINE
HYDROGEN PEROXIDE	H2O2	20%	PHTTPV	A - S - KC	
HYDROGEN PEROXIDE	H2O2	100%	KCMTTKV	A - S	
POLYOL	***	ALL	PHTSPV	A	HIGH DENSITY
HALOGENATED SOLVENTS	***	ALL	KCMTTKT	***	NO ALUMINIUM
TOLUENE	C7H8	ALL	AHTTAT	S - KC - Z	
AMMONIA	NH3	ALL	PHTTPD	S	
XYLENE	C8H10	ALL	AHTTPD	S	

## MATERIAL LIST

A	→	ALUMINIUM
D	→	EPDM
H	→	HYTREL / KEYFLEX
KC	→	PVDF + CF
M	→	SANTOPRENE
N	→	NBR
P	→	POLYPROPYLENE
PC	→	POLYPROPYLENE + CF
S	→	INOX AISI 316
T	→	PTFE / TEFLON
V	→	FPM / VITON
Z	→	POLYETHYLENE / POLIZENE

PH 14



PH 7



PH 1

ALKALINE / BASIC

PP / EPDM

NEUTRAL

ACIDS

PVDF / PP / VITON

# TROLLEYS FOR TRANSPORT OF OIL, GREASE AND SIMILAR DRUMS



Modular and varnished trolleys, advised for the transport of drums (oil - grease - similar) of 16<220 Kg in work places.



## TROLLEYS FOR THE TRANSPORT OF OIL, GREASE AND SIMILAR DRUMS



**030-1392-000**

### Art. 030-1392-000

Trolley for drums of 16-60 Kg

Equipped with:  
2 wheels Ø 150 mm  
Band for fixing drums  
Adjustable base



030-1392-000 6,000 0,051 1

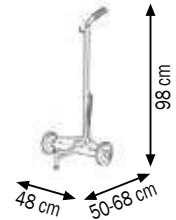
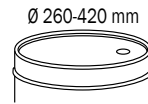

**030-1393-000**

### Art. 030-1393-000

Trolley for drums of 16-30 Kg

Equipped with:  
2 pneumatic wheels Ø 220 mm  
Band for fixing drums  
Base dimension 350 x 240 mm



030-1393-000 7,700 0,051 1

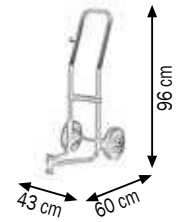
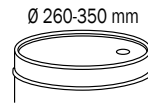

**030-1394-000**

### Art. 030-1394-000

Trolley for drums of 50-60 Kg

Equipped with:  
2 pneumatic wheels Ø 220 mm  
Band for fixing drums  
Base dimension 400 x 300 mm



030-1394-000 7,900 0,072 1

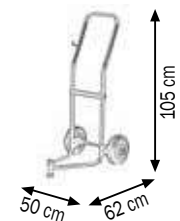
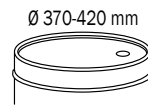

**030-1395-000**

### Art. 030-1395-000

Trolley for drums of 50-60 Kg

Equipped with:  
2 fixed wheels Ø 125 mm  
2 swivelling wheels Ø 60 mm  
Base dimension 410 x 410 mm



030-1395-000 13,600 0,072 1

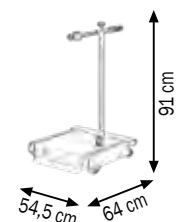
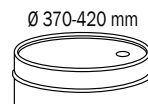

Modular and varnished trolleys, advised for the transport of drums (oil – grease - similar) of 16<60 Kg in work places.

# TROLLEYS FOR THE TRANSPORT OF OIL, GREASE AND SIMILAR DRUMS



## Art. 030-1398-000

Trolley for drums of 180-220 Kg

Pre-arranged for the application of the hose reel

Equipped with:

2 fixed wheels Ø 200 mm

1 swivelling wheel Ø 125 mm

(equipped with locking device)

Band for fixing drums

Base dimension 600x470 mm

			
030-1398-000	21,900	0,170	1

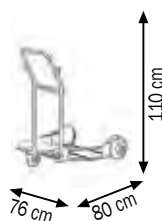
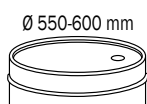

030-1398-000

## Art. 030-1400-000

Trolley for drums of 180-220 Kg

Equipped with:

2 fixed wheels Ø 250 mm

2 swivelling wheels Ø 125 mm

Base dimension 610x610 mm

			
030-1400-000	37,000	0,170	1

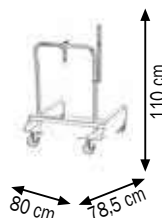
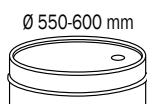

030-1400-000

## Art. 030-1405-000

Trolley for drums of 180-220 Kg

Pre-arranged for the application of the hose reel





Equipped with:

2 fixed wheels Ø 250 mm

2 swivelling wheels Ø 180 mm

(one is equipped with locking device)

Base dimension 610x610 mm

			
030-1405-000	46,200	0,170	1

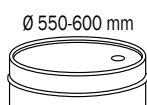

030-1405-000

Modular and varnished trolleys, advised for the transport of drums (oil – grease - similar) of 180<220 Kg in work places.



**030-1407-000**

## Art. 030-1407-000

Special trolley for drums of 180-220 l

Equipped with:

2 pneumatic wheels  $\varnothing$  380 mm

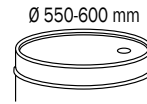

**030-1408-000**

## Art. 030-1408-000

Hydraulic lift trolley for drums of 180-220 l

Equipped with:

Hydraulic pedal pump

Collet self-locking

2 fixed wheels  $\varnothing$  80 mm

2 swivelling wheels  $\varnothing$  125 mm

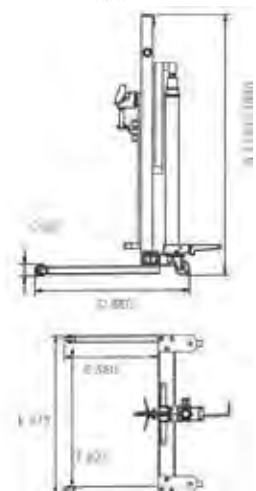
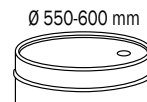

Technical Data		030- 1408-000
Piston stroke	mm	650
Max delivery	kg	250
Dimensions A	mm	1340/1840
Dimensions B	mm	580
Dimensions C	mm	80
Dimensions D	mm	880
Dimensions E	mm	975
Dimensions F	mm	825

Lift trolleys for drums suitable for the substitution of drums up to 220 kg on the tanks of dump. It's simple, effortless and it can be used by only one person.

# EXHAUSTED OIL ASPIRATORS



The air-operated oil aspirators are ideal for a rapid changing of motor oil to every vehicle. After depressurization they work autonomously, without the need to be connected to compressed air, for an independent and quick aspiration, using the suitable probe between the included kit of 10 probes.

The units can suction till 2/3 of their capacity.

Change the oil at a temperature of 60° - 80° C (when the engine is just switched off).

Warning: do not use these units for the suction of brake oils, fuels and inflammable liquids



The air-operated oil aspirators are ideal for a rapid changing of motor oil to every vehicle. After depressurization they work autonomously, without the need to be connected to compressed air, for an independent and quick aspiration, using the suitable probe between the included kit of 10 probes.

The units can suction till  $2/3$  of their capacity.

Change the oil at a temperature of  $60^{\circ} - 80^{\circ} \text{C}$  (when the engine is just switched off).

**Warning:** do not use these units for the suction of brake oils, fuels and inflammable liquids





AIR-OPERATED OIL ASPIRATORS

page 232



AIR-OPERATED OIL ASPIRATORS AND DRAIN UNITS

page 234



AIR-OPERATED OIL ASPIRATORS AND DRAIN UNITS WITH PANTOGRAPH

page 237



WHEELED OIL ASPIRATORS WITH PUMP

page 241



WALL-FIXING OIL ASPIRATORS WITH PUMP

page 242



OIL ASPIRATORS WITH DIAPHRAGM PUMP

page 243



KITS WITH AIR-OPERATED DIAPHRAGM PUMPS FOR SUCTION-TRANSFER OIL

page 244



PROBES FOR OIL ASPIRATORS

page 246



**040-1418-000**

## Art. 040-1418-000

### Air-operated exhausted oil aspirator 24 l

Tank capacity 24 l with level indicator

Manual air emptying of tank

Equipped with 10 standard probes (Art.044-1479-000)



**040-1418-000** 13,100 0,081 1

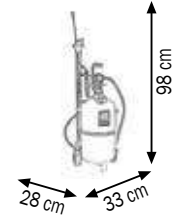

## Art. 040-1420-000

### Air-operated exhausted oil aspirator 24 l

Tank capacity 24 l with level indicator

Manual air emptying of tank (max pressure 0,5 bar)

Equipped with 10 standard probes (Art.044-1479-000)



**040-1420-000** 14,200 0,074 1

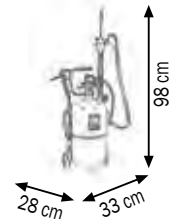

**040-1420-000**

## Art. 040-1427-000

### Industrial air-operated aspirator for liquids 90 l

Tank capacity 90 l with level indicator

Abs tool holder basin with 3 sections

Pneumatic air emptying of tank (max pressure 0,5 bar)

Equipped with 2 probes Ø 12 and Ø 20mm

Suction capacity 25 l/min



**040-1427-000** 29,600 0,240 1

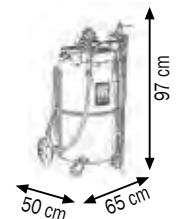

**040-1427-000**

Technical data		040-1418-000	040-1420-000	040-1427-000
Air pressure for depressurisation	bar	7,5 - 8	7,5 - 8	7,5 - 8
Depressurisation time	l/min	1' - 1,5'	1' - 1,5'	2,5' - 3'
Max suction capacity with a depressurisation	l	13 - 16	13 - 16	60 - 65
Suction time with Ø 6 and oil at 60 - 80 °C temperature	l/min	1,5 - 2	1,5 - 2	1,5 - 2
Suction hose-emptying - hose length	m	2	2	2

The air-operated oil aspirators are ideal for a rapid changing of motor oil to every vehicle.

After depressurization they work autonomously, without the need to be connected to compressed air, for an independent and quick aspiration, using the suitable probe between the included kit of 10 probes.

The units can suction till 2/3 of their capacity.

**Change the oil at a temperature of 60° - 80° C (when the engine is just switched off).**

**Warning:** do not use these units for the suction of brake oils, fuels and inflammable liquids

## Art. 040-1424-000

### Air-operated exhausted oil aspirator 65 l

Tank capacity 65 l with level indicator  
Abs tool holder basin with 3 sections  
Pneumatic air emptying of tank (max pressure 0,5 bar)  
Equipped with 10 standard probes (Art.044-1479-000)

040-1424-000	24,600	0,220	1

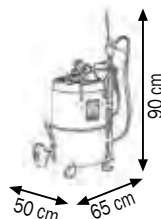

040-1424-000

## Art. 040-1425-000

### Air-operated exhausted oil aspirator 90 l

Tank capacity 90 l with level indicator  
Abs tool holder basin with 3 sections  
Pneumatic air emptying (max pressure 0,5 bar)  
Equipped with 10 standard probes (Art.044-1479-000)

040-1425-000	27,100	0,240	1

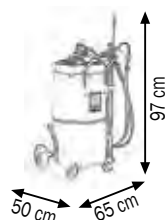

040-1425-000

## Art. 040-1428-000

### Air-operated exhausted oil aspirator 120 l

Tank capacity 120 l with level indicator  
Abs tool holder basin with 3 sections  
Pneumatic air emptying (max pressure 0,5 bar)  
Equipped with 10 standard probes (Art.044-1479-000)

040-1428-000	27,200	0,310	1

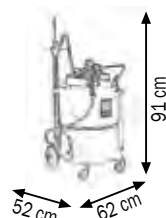

040-1428-000

Technical data		040-1424-000	040-1425-000	040-1428-000
Air pressure for depressurisation	bar	7,5 - 8	7,5 - 8	7,5 - 8
Depressurisation time	l/min	2' - 2,5'	2,5' - 3'	3' - 3,5'
Max suction capacity with a depressurisation	l	43 - 45	60 - 65	85 - 90
Suction time with Ø 6 and oil at 60 - 80 °C temperature	l/min	1,5 - 2	1,5 - 2	1,5 - 2
Suction hose-emptying - hose length	m	2	2	2

The air-operated oil aspirators are ideal for a rapid changing of motor oil to every vehicle. After depressurization they work autonomously, without the need to be connected to compressed air, for an independent and quick aspiration, using the suitable probe between the included kit of 10 probes. The units can suction till 2/3 of their capacity.

**Change the oil at a temperature of 60° - 80° C (when the engine is just switched off).**

**Warning:** do not use these units for the suction of brake oils, fuels and inflammable liquids

## AIR-OPERATED SUCTION-DRAINERS FOR EXHAUSTED OIL



**040-1430-000**

### Art. 040-1430-000

**Air-operated oil suction-drainer for exhausted oil 65 l**

Tank capacity 65 l with level indicator

Abs tool holder basin with 3 sections

Recovery basin capacity 15 l

with breakwater grate to drip the substituted oil filters

Pneumatic air emptying (max pressure 0,5 bar)

Equipped with 10 standard probes (Art.044-1479-000)



040-1430-000 30,400 0,240 1

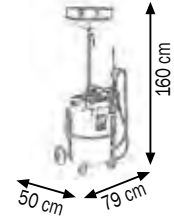

**040-1432-000**

### Art. 040-1432-000

**Air-operated oil suction-drainer for exhausted oil 90 l**

Tank capacity 90 l with level indicator

Abs tool holder basin with 3 sections

Recovery basin capacity 20 l

with ergonomic and 360° swivelling abs funnel

with breakwater grate to drip the substituted oil filters

Pneumatic air emptying (max pressure 0,5 bar)

Equipped with 10 standard probes (Art.044-1479-000)



040-1432-000 37,400 0,240 1

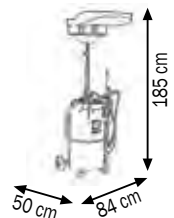

**040-1433-000**

### Art. 040-1433-000

**Air-operated oil suction-drainer for exhausted oil 120 l**

Tank capacity 120 l with level indicator

Abs tool holder basin with 3 sections

Recovery basin capacity 20 l

with ergonomic and 360° swivelling abs funnel

with breakwater grate to drip the substituted oil filters

Pneumatic air emptying (max pressure 0,5 bar)

Equipped with 10 standard probes (Art. 044-1479-000)



040-1433-000 38,700 0,310 1

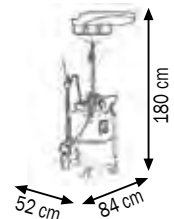

Technical data		040-1430-000	040-1432-000	040-1433-000
Air pressure for depressurisation	bar	7,5 - 8	7,5 - 8	7,5 - 8
Depressurisation time	l/min	2' - 2,5'	2,5' - 3'	3' - 3,5'
Max suction capacity with a depressurisation	l	43 - 45	60 - 65	85 - 90
Suction time with Ø 6 and oil at 60 - 80 °C temperature	l/min	1,5 - 2	1,5 - 2	1,5 - 2
Suction hose-emptying - hose length	m	2	2	2

The air-operated oil aspirators are ideal for a rapid changing of motor oil to every vehicle.

The recovery of the exhausted oil is carried out for fall, through the lateral basin adjustable for height, and also through aspiration thanks to the probes.

After depressurization they work autonomously, without the need to be connected to compressed air, for an independent and quick aspiration, using the suitable probe between the included kit of 10 probes.

The units can suction till 2/3 of their capacity.

**Change the oil at a temperature of 60° - 80° C (when the engine is just switched off).**

**Warning:** do not use these units for the suction of brake oils, fuels and inflammable liquids

# AIR-OPERATED ASPIRATORS FOR EXHAUSTED OIL WITH PRE-CHAMBER



## Art. 040-1434-000

**Air-operated aspirator for exhausted oil 65 l with pre-chamber**

Tank capacity 65 l with level indicator

Abs tool holder basin with 3 sections

Pre-chamber capacity 10 l

Pneumatic air emptying (max pressure 0,5 bar)

Equipped with 10 standard probes (Art.044-1479-000)



040-1434-000 29,400 0,240 2

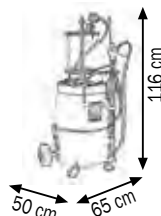

040-1434-000

## Art. 040-1435-000

**Air-operated aspirator for exhausted oil 90 l with pre-chamber**

Tank capacity 90 l with level indicator

Abs tool holder basin with 3 sections

Pre-chamber capacity 10 l

Pneumatic air emptying (max pressure 0,5 bar)

Equipped with 10 standard probes (Art.044-1479-000)



040-1435-000 32,200 0,290 2

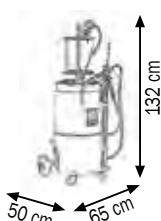

040-1435-000

## Art. 040-1438-000

**Air-operated aspirator for exhausted oil 120 l with pre-chamber**

Tank capacity 120 l with level indicator

Abs tool holder basin with 3 sections

Pre-chamber capacity 10 l

Pneumatic air emptying (max pressure 0,5 bar)

Equipped with 10 standard probes (Art.044-1479-000)



040-1438-000 32,300 0,310 2

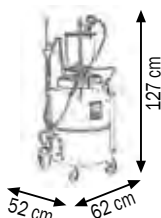

040-1438-000

Technical data		040-1434-000	040-1435-000	040-1438-000
Air pressure for depressurisation	bar	7,5 - 8	7,5 - 8	7,5 - 8
Depressurisation time	l/min	2' - 2,5'	2,5' - 3'	3' - 3,5'
Max suction capacity with a depressurisation	l	43 - 45	60 - 65	85 - 90
Suction time with Ø 6 and oil at 60 - 80 °C temperature	l/min	1,5 - 2	1,5 - 2	1,5 - 2
Suction hose-emptying - hose length	m	2	2	2

The air-operated oil aspirators are ideal for a rapid changing of motor oil to every vehicle.

After depressurization they work autonomously, without the need to be connected to compressed air, for an independent and quick aspiration, using the suitable probe between the included kit of 10 probes.

The units can suction till 2/3 of their capacity.

**The pre-chamber permits the immediate control of quantity and quality of the aspirated oil, it is equipped with a device for the internal cleaning.**

**Change the oil at a temperature of 60° - 80° C (when the engine is just switched off).**

**Warning:** It is not possible to suck brake oils, fuels, inflammable and corrosive liquids.



## Art. 040-1442-000

### Air-operated suction-drainer for exhausted oil 65 l with pre-chamber

Tank capacity 65 l with level indicator  
 Abs tool holder basin with 3 sections  
 Pre-chamber capacity 10 l  
 Recovery basin capacity 15 l  
 with breakwater grate to drip the substituted oil filters  
 Pneumatic air emptying (max pressure 0,5 bar)  
 Equipped with 10 standard probes (Art.044-1479-000)



040-1442-000 35,200 0,290 2

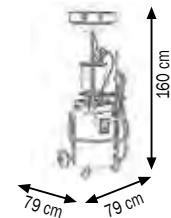

## Art. 040-1445-000

### Air-operated suction-drainer for exhausted oil 90 l with pre-chamber

Tank capacity 90 l with level indicator  
 Abs tool holder basin with 3 sections  
 Pre-chamber capacity 10 l  
 Recovery basin capacity 20 l  
 with ergonomic and 360° swivelling abs funnel  
 with breakwater grate to drip the substituted oil filters  
 Pneumatic air emptying (max pressure 0,5 bar)  
 Equipped with 10 standard probes (Art.044-1479-000)



040-1445-000 42,300 0,290 2

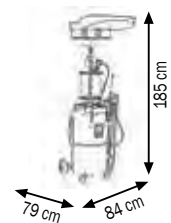

## Art. 040-1448-000

### Air-operated suction-drainer for exhausted oil 120 l with pre-chamber

Tank capacity 120 l with level indicator  
 Abs tool holder basin with 3 sections  
 Pre-chamber capacity 10 l  
 Recovery basin capacity 20 l  
 with ergonomic and 360° swivelling abs funnel  
 with breakwater grate to drip the substituted oil filters  
 Pneumatic air emptying (max pressure 0,5 bar)  
 Equipped with 10 standard probes (Art.044-1479-000)



040-1448-000 43,800 0,360 2

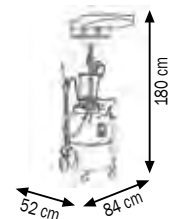

Technical data		040-1442-000	040-1445-000	040-1448-000
Air pressure for depressurisation	bar	7,5 - 8	7,5 - 8	7,5 - 8
Depressurisation time	l/min	2' - 2,5'	2,5' - 3'	3' - 3,5'
Max suction capacity with a depressurisation	l	43 - 45	60 - 65	85 - 90
Suction time with Ø 6 and oil at 60 - 80 °C temperature	l/min	1,5 - 2	1,5 - 2	1,5 - 2
Suction hose-emptying - hose length	m	2	2	2

The air-operated oil aspirators are ideal for a rapid changing of motor oil to every vehicle. The recovery of the exhausted oil is carried out for fall, through the lateral basin adjustable for height, and also through aspiration thanks to the probes. After depressurization they work autonomously, without the need to be connected to compressed air, for an independent and quick aspiration, using the suitable probe between the included kit of 10 probes. The units can suction till 2/3 of their capacity.

**The pre-chamber permits the immediate control of quantity and quality of the aspirated oil, it is equipped with a device for the internal cleaning.**

**Change the oil at a temperature of 60° - 80 °C (when the engine is just switched off).**

**Warning:** do not use these units for the suction of brake oils, fuels and inflammable liquids

# AIR OPERATED ASPIRATORS-SUCTION DRAINERS FOR EXHAUSTED OIL WITH PANTOGRAPH FOR CARS AND MOTORCYCLES



## Art. 041-1449-000

Exhausted oil drain units with pantograph 65 l  
For MOTORCYCLES

Tank capacity 65 l with level indicator  
Abs tool holder basin with 3 sections  
Recovery basin capacity 14 l on arms pantograph with breakwater grate to drip the substituted oil filters  
Pneumatic air emptying (max pressure 0,5 bar)  
Is not equipped with aspiration group and probes



041-1449-000 39,600 0,450 1

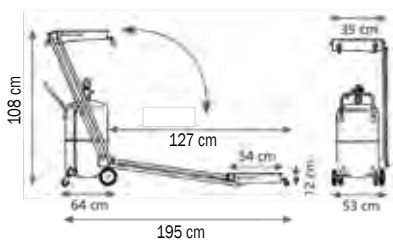

041-1449-000

## Art. 041-1451-000

Exhausted oil aspirators-suction drainer with pantograph 65 l  
For CARS AND MOTORCYCLES

Tank capacity 65 l with level indicator  
Abs tool holder basin with 3 sections  
Recovery basin capacity 14 l on arms pantograph with breakwater grate to drip the substituted oil filters  
Pneumatic air emptying (max pressure 0,5 bar)  
Equipped with 10 standard probes (Art.044-1479-000)



041-1451-000 40,600 0,450 1

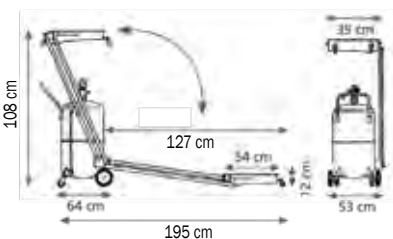

041-1451-000



Technical data		041-1449-000	041-1451-000
Air pressure for depressurisation	bar	-	7,5 - 8
Depressurisation time	l/min	-	2' - 2,5'
Max suction capacity with a depressurisation	l	-	43 - 45
Suction time with Ø 6 and oil at 60 - 80 °C temperature	l/min	-	1,5 - 2
Suction hose-emptying - hose length	m	2	2

The air-operated aspirators-suction drainers are used for the recovery of the exhausted oil by fall with tank (14 l), that can be put on the floor or lifted on lifts for vehicles.

After depressurization they work autonomously, without the need to be connected to compressed air, for an independent and quick aspiration, using the suitable probe between the included kit of 10 probes.

The units can suction till 2/3 of their capacity.

**Change the oil at a temperature of 60° - 80 °C (when the engine is just switched off).**

**Warning:** do not use these units for the suction of brake oils, fuels and inflammable liquids



**041-1450-000**

## Art. 041-1450-000

### Air-operated oil suction-drainer with pantograph 65 l

Tank capacity 65 l with level indicator  
 Abs tool holder basin with 3 sections  
 Recovery basin capacity 14 l on arms pantograph with breakwater grate to drip the substituted oil filters  
 Pneumatic air emptying (max pressure 0,5 bar)  
 Equipped with 10 standard probes (Art.044-1479-000)



**041-1450-000** 42,600 0,450 1

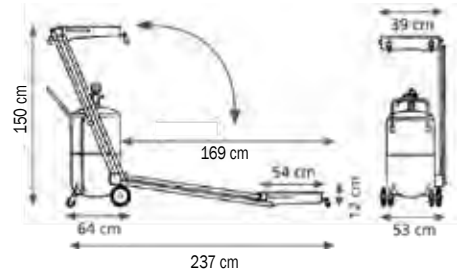

**041-1452-000**

## Art. 041-1452-000

### Air-operated oil suction-drainer with pantograph 90 l

Tank capacity 90 l with level indicator  
 Abs tool holder basin with 3 sections  
 Recovery basin capacity 14 l on arms pantograph with breakwater grate to drip the substituted oil filters  
 Pneumatic air emptying (max pressure 0,5 bar)  
 Equipped with 10 standard probes (Art.044-1479-000)



**041-1452-000** 44,400 0,450 1

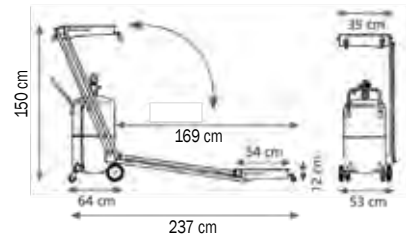

Technical data		041-1450-000	041-1452-000
Air pressure for depressurisation	bar	7,5 - 8	7,5 - 8
Depressurisation time	l/min	2' - 2,5'	2,5' - 3'
Max suction capacity with a depressurisation	l	43 - 45	60 - 65
Suction time with Ø 6 and oil at 60 - 80 °C temperature	l/min	1,5 - 2	1,5 - 2
Suction hose-emptying - hose length	m	2	2

The air-operated aspirators-suction drainers are used for the recovery of the exhausted oil by fall with tank (14 l), that can be put on the floor or lifted on lifts for vehicles. This operation can be done also through aspiration, after depressurization they work autonomously, without the need to be connected to compressed air, for an independent and quick aspiration, using the suitable probe between the included kit of 10 probes. The units can suction till 2/3 of their capacity.

**Change the oil at a temperature of 60° - 80° C (when the engine is just switched off).**

**Warning:** do not use these units for the suction of brake oils, fuels and inflammable liquids

# AIR-OPERATED OIL SUCTION-DRAINERS FOR EXHAUSTED OIL WITH PANTOGRAPH AND PRE-CHAMBER



## Art. 041-1454-000

### Air-operated exhausted oil suction-drainer with pantograph 65 l and pre-chamber

Tank capacity 65 l with level indicator  
 Abs tool holder basin with 3 sections  
 Pre-chamber capacity 10 l  
 Recovery basin capacity 14 l on arms pantograph with breakwater grate to drip the substituted oil filters  
 Pneumatic air emptying (max pressure 0,5 bar)  
 Equipped with 10 standard probes (Art.044-1479-000)



041-1454-000 46,100 0,450 1

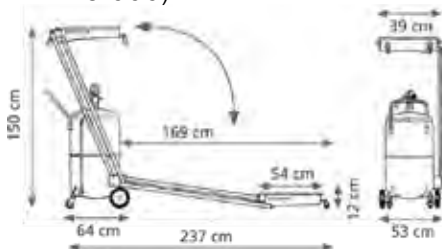

041-1454-000

## Art. 041-1455-000

### Air-operated exhausted oil suction-drainer with pantograph 90 l and pre-chamber

Tank capacity 90 l with level indicator  
 Abs tool holder basin with 3 sections  
 Pre-chamber capacity 10 l  
 Recovery basin capacity 14 l on arms pantograph with breakwater grate to drip the substituted oil filters  
 Pneumatic air emptying (max pressure 0,5 bar)  
 Equipped with 10 standard probes (Art.044-1479-000)



041-1455-000 48,500 0,450 1

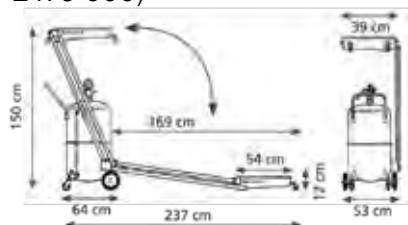

041-1455-000

Technical data		041-1454-000	041-1455-000
Air pressure for depressurisation	bar	7,5 - 8	7,5 - 8
Depressurisation time	l/min	2' - 2,5'	2,5' - 3'
Max suction capacity with a depressurisation	l	43 - 45	60 - 65
Suction time with Ø 6 and oil at 60 - 80 °C temperature	l/min	1,5 - 2	1,5 - 2
Suction hose-emptying - hose length	m	2	2

The air-operated aspirators-suction drainers are used for the recovery of the exhausted oil by fall with tank (14 l), that can be put on the floor or lifted on lifts for vehicles. This operation can be done also through aspiration, after depressurization they work autonomously, without the need to be connected to compressed air, for an independent and quick aspiration, using the suitable probe between the included kit of 10 probes.

The units can suction till 2/3 of their capacity.

**The pre-chamber permits the immediate control of quantity and quality of the aspirated oil, it is equipped with a device for the internal cleaning.**

**Change the oil at a temperature of 60° - 80° C (when the engine is just switched off).**

**Warning:** do not use these units for the suction of brake oils, fuels and inflammable liquids

## AIR-OPERATED OIL SUCTION-DRAINERS FOR EXHAUSTED OIL WITH PANTOGRAPH



**041-1453-000**

### Art. 041-1453-000

#### Air-operated exhausted oil suction-drainer with pantograph 120 l

Tank capacity 120 l with level indicator

Abs tool holder basin with 3 sections

Recovery basin capacity 14 l on arms pantograph with breakwater grate to drip the substituted oil filters

Pneumatic air emptying (max pressure 0,5 bar)

Equipped with 10 standard probes (Art.044-1479-000)



**041-1453-000** 45,900 0,520 1

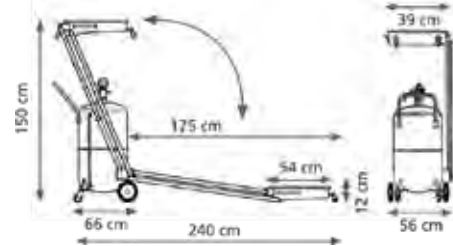

**041-1456-000**

### Art. 041-1456-000

#### Air-operated exhausted oil suction-drainer with pantograph 120 l

##### For TRUCKS

Tank capacity 120 l with level indicator

Abs tool holder basin with 3 sections

Recovery basin capacity 50 l on arms pantograph with breakwater grate to drip the substituted oil filters

Pneumatic air emptying (max pressure 0,5 bar)

Equipped with 10 standard probes (Art.044-1479-000)



**041-1456-000** 55,000 0,650 1

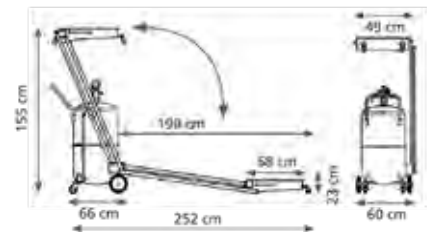

Technical data		041-1453-000	041-1456-000
Air pressure for depressurisation	bar	7,5 - 8	7,5 - 8
Depressurisation time	l/min	3' - 3,5'	3' - 3,5'
Max suction capacity with a depressurisation	l	85 - 90	85 - 90
Suction time with Ø 6 and oil at 60 - 80 °C temperature	l/min	1,5 - 2	1,5 - 2
Suction hose-emptying - hose length	m	2	2

The air-operated aspirators-suction drainers are used for the recovery of the exhausted oil by fall with tank (14-50l), that can be put on the floor or lifted on lifts for vehicles. This operation can be done also through aspiration, after depressurization they work autonomously, without the need to be connected to compressed air, for an independent and quick aspiration, using the suitable probe between the included kit of 10 probes. The units can suction till 2/3 of their capacity.

**Change the oil at a temperature of 60° - 80° C (when the engine is just switched off).**

**Warning:** do not use these units for the suction of brake oils, fuels and inflammable liquids

# WHEELED ASPIRATORS FOR EXHAUSTED OIL WITH PNEUMATIC PUMP



## Art. 042-1410-000

Wheeled aspirator with pump for drums of 50-60 l

Composed by:

- Art.020-1165-000 Air-operated pump **ratio=1:1**
- Equipped with the flow rate adjuster and the vacuum gauge
- Art.030-1395-000 4-wheels trolley
- Art.044-1479-000 Set 10 standard probes
- 2 m aspiration - delivery hoses
- Art.024-1232-F00 Oil dispensing nozzle with flexible end

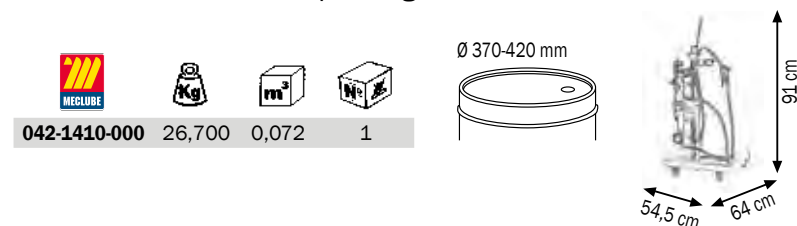

042-1410-000

## Art. 042-1411-000

Wheeled aspirator with pump for drums of 180-220 l

Composed by:

- Art.020-1165-000 Air-operated pump **ratio=1:1**
- Equipped with the flow rate adjuster and the vacuum gauge
- Art.030-1400-000 4-wheels trolley
- Art.044-1479-000 Set 10 standard probes
- 2 m aspiration - delivery hoses
- Art.024-1232-F00 Oil dispensing nozzle with flexible end

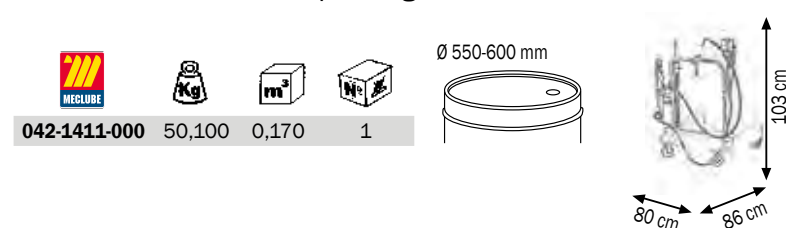

042-1411-000

## Art. 042-1412-000

Air-operated oil suction-drainer 90 l with pneumatic oil pump

Pneumatic air emptying (max pressure 0,5 bar)

Composed by:

- Tank capacity 90 l with level indicator
- Abs tool holder basin with 3 sections
- Art.020-1165-000 Air-operated pump **ratio=1:1**
- Equipped with the flow rate adjuster and the vacuum gauge
- Recovery basin capacity 20 l
- with ergonomic and **360° swivelling** abs funnel
- with breakwater grate to drip the substituted oil filters
- Art.044-1479-000 Set 10 standard probes
- 2 m aspiration - delivery hoses

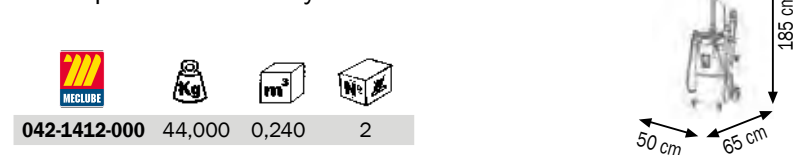

042-1412-000

Suitable for the aspiration of exhausted oil and similar fluids from every motor vehicle. When you reverse the position of the two hoses the aspirator can deliver the aspirated fluids.

**Warning:** It is not possible to suck brake oils, fuels, inflammable and corrosive liquids.

## WALL-FIXING ASPIRATORS FOR EXHAUSTED OIL WITH PNEUMATIC PUMP



042-1304-000

### Art. 042-1304-000

Wall-fixing aspirator for emptying exhausted oil aspirator/suction-drainer

Composed by:

Art.020-1168-000 Air-operated pump **ratio=1:1**

Equipped with the flow rate adjuster

Art.R34-0002-006 Y-shaped in-line F-F 1"

Art.F96-0100-606 Nipple 1" BSP-1" BSP

Art.025-1265-000 Wall-fixing bracket

Art.910-0600-020 Flex hose Ø 25mm 2m

Art.B27-1132-035 n 2 stainless steel screw clamps 32-35 mm

Art.R18-0855-255 Rubber connection M 1" Ø 25mm

Art.F96-0500-005 Quick disconnect coupling female 3/4"

Art.F96-0502-005 Quick disconnect coupling male 3/4"



042-1304-000 10,600 0,072 1

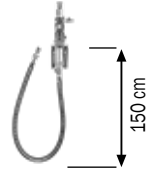

042-1413-000

### Art. 042-1413-000

Wall-fixing aspirator for exhausted oil with pump

Composed by:

Art.020-1168-000 Air-operated pump **ratio=1:1**

Equipped with the flow rate adjuster and the vacuum gauge

Art.025-1265-000 Wall-fixing bracket

Art.042-5805-010 Wall plate with drip tray

Art.044-1479-A00 Probe holder fitting with lever valve

Art.044-1479-000 Set 10 standard probes

Art.044-1498-000 Probe Ø 12 mm

Art.044-1505-000 Wall-fixing holder for probes

Art.916-0411-040 spirac 4m aspiration Ø 12 M-M 1/4 - delivery hose

Art.906-0404-040 1SC 1/2" hose M-F 4 m with plastic support

Art.024-1232-F00 Oil dispensing nozzle with flexible end



042-1413-000 29,500 0,031 2

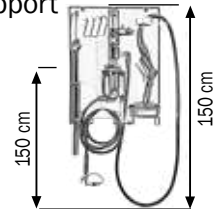

042-1414-000

### Art. 042-1414-000

Wall-fixing aspirator for exhausted oil with pump

Composed by:

Art.020-1168-000 Air-operated pump **ratio=1:1**

Equipped with the flow rate adjuster and the vacuum gauge

Art.071-1206-410 Swiveling hose reel with 1SC 1/2" hose 10m length

Art.025-1265-000 Wall-fixing bracket

Art.042-5805-010 Wall plate with drip tray

Art.044-1479-A00 Probe holder fitting with lever valve

Art.044-1479-000 Set 10 standard probes

Art.044-1498-000 Probe Ø 12 mm

Art.044-1505-000 Wall-fixing holder for probes

Art.906-0424-015 1SC 1/2" hose F-F 1,5m length

Art.906-0404-040 1SC 1/2" hose M-F 4 m with plastic support

Art.024-1232-F00 Oil dispensing nozzle with flexible end



042-1414-000 47,300 0,083 3

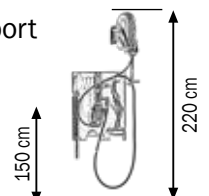

**ATTENTION:** It is necessary to loosen the working of the pump through the flux adjuster to maintain the vacuum gauge in the optimal position of - 0,6.

**Warning:** It is not possible to suck brake oils, fuels, inflammable and corrosive liquids

# AIR-OPERATED DIAPHRAGM PUMPS KITS FOR EXHAUSTED OIL



## Art. 042-1417-000

Wall-fixing aspirators with air-operated diaphragm pump for emptying exhausted oil aspirator/suction-drainer

Composed by:

- Art.028-A110-AB1 Aluminium diaphragm pump **R= 1:1 110 l/min**
- Art.025-1266-001 Wall-fixing bracket
- Art.R34-0002-005 Y-shaped brass in-line filter F-F 3/4"
- Art.F96-0100-505 Nipple 3/4" BSP-3/4" BSP
- Art.910-0600-020 Flex hose Ø 25 mm 2 m length
- Art.B27-1132-035 n 2 stainless steel screw clamps 32-35 mm
- Art.R18-0803-255 n 2 Rubber connection M 3/4" Ø 25mm
- Art.F96-0500-005 Quick disconnect coupling female 3/4"
- Art.F96-0502-005 Quick disconnect coupling male 3/4"



042-1417-000



042-1417-000 12,700 0,072 1

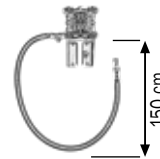

## Art. 042-1415-000

Aspirators with wall-fixing air-operated diaphragm pump for exhausted oil

Composed by:

- Art.028-A110-AB1 Aluminium diaphragm pump **R= 1:1 110 l/min**  
Equipped with the flow rate adjuster and the vacuum gauge
- Art.025-1266-001 Wall-fixing bracket
- Art.042-5805-010 Wall plate with drip tray
- Art.071-1206-410 Swiveling hose reel with 1SC 1/2" hose 10m length
- Art.044-1479-A00 Probe holder fitting with lever valve
- Art.044-1479-000 Set 10 standard probes
- Art.044-1498-000 Probe Ø 12 mm
- Art.044-1505-000 Wall-fixing holder for probes
- Art.F96-0100-504 n2 Nipple 3/4" BSP-1/2" BSP
- Art.906-0424-015 1SC 1/2" hose F-F 1,5m length
- Art.906-0404-040 1SC 1/2" hose M-F 4 m length
- Art.024-1232-F00 Oil dispensing nozzle with flexible end



042-1415-000



042-1415-000 47,000 0,100 4

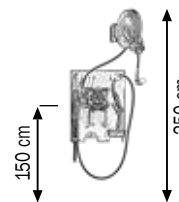

## Art. 042-1416-000

Aspirators support with air-operated diaphragm pump for exhausted oil

Composed by:

- Art.023-1968-001 Service support
- Art.028-A110-AB1 Aluminium diaphragm pump **R= 1:1 110 l/min**  
Equipped with the flow rate adjuster and the vacuum gauge
- Art.025-1266-001 Wall-fixing bracket
- Art.071-1206-410 Swiveling hose reel with 1SC 1/2" hose 10m length
- Art.044-1479-A00 Probe holder fitting with lever valve
- Art.044-1479-000 Set 10 standard probes
- Art.044-1498-000 Probe Ø 12 mm
- Art.044-1505-000 Wall-fixing holder for probes
- Art.F96-0100-504 n2 Nipple 3/4" BSP-1/2" BSP
- Art.906-0424-015 1SC 1/2" hose F-F 1,5m length
- Art.906-0404-040 1SC 1/2" hose M-F 4 m



042-1416-000



042-1416-000 88,300 0,660 4

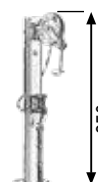

## Art. 042-1500-170

### Wheeled kit with air-operated diaphragm pump for suction-transfer oil

Equipped with:

- Art.028-A170-AB1 Diaphragm pump of aluminium **R=1:1** 1" 170 l/min
- Art.030-1398-000 3-wheels trolley for drums of 180-220 l
- Art.F96-0800-006 4 ways evacuation valve F1"
- Art.F96-0100-604 Nipple 1" 1/2" BSP
- Art.F96-0100-606 Nipple 1" 1" BSP
- Art.R18-1250-006 n3 stainless steel connection 90° M-F 1"
- Art.R18-0803-256 n3 Rubber connection M 1" Ø 25mm
- Art.044-1479-A00 Probe holder fitting with lever valve
- Art.044-1485-000 Flexible probe Ø 8 l 800 mm
- Art.044-1502-000 Flexible probe Ø 12 l 800 mm
- Art.044-1504-000 Probe holder tube
- Art.025-1270-094 Suction kit flex hose 2 m + threaded
- Art.906-0404-030 1SC 1/2" hose M-F 3,0 m length
- Art.911-0500-011 Spiral suction hose 20x25 1,10 m length
- Art.B27-1120-032 n2 stainless steel hose clamp 20x32 mm



**042-1500-170**

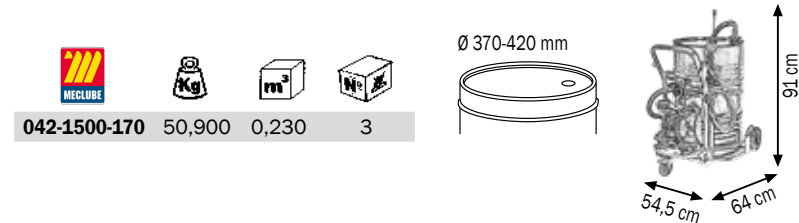

## Art. 042-1510-110

### Wheeled kit with air-operated diaphragm pump for suction-transfer oil

Equipped with:

- Art.028-A110-AB1 Diaphragm pump of aluminium **R=1:1** 1" 110 l/min
- Art.030-1405-000 4-wheels trolley for drums of 180/220 l
- Art.042-0005-001 Bracket support pumps and hose reel 773x185 mm
- Art.070-1206-410 Hose reel with 1SC 1/2" hose 10,0 m length
- Art.F96-0800-006 4 ways evacuation valve F1"
- Art.F96-0100-604 Nipple 1" 1/2" BSP
- Art.F96-0100-605 Nipple 1" 3/4" BSP
- Art.R18-1250-006 n3 stainless steel connection 90° M-F 1"
- Art.R18-0803-256 n2 Rubber connection M 1" Ø 25mm
- Art.044-1479-A00 Probe holder fitting with lever valve
- Art.044-1485-000 Flexible probe Ø 8 l 800 mm
- Art.044-1498-000 Flexible probe Ø 12 l 800 mm
- Art.044-1504-000 Probe holder tube
- Art.025-1270-094 Suction kit flex hose 2 m + threaded
- Art.906-0424-010 1SC 1/2" hose F-F 1,0 m length
- Art.911-0500-011 Spiral suction hose 20x25 1,10 m length
- Art.B27-1120-032 n2 stainless steel hose clamp 20x32 mm



**042-1510-110**

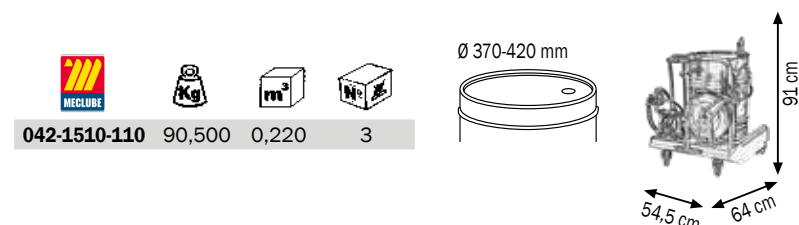

## Art. 042-1550-055

wall-fixing kit diaphragm pumps mod. A55 for transfer oil

Equipped with:

- Art.028-A055-AB1 Diaphragm pump of aluminium **R=1:1** 1/2" 55 l/min
- Art.025-1266-001 Wall-fixing bracket
- Art.R34-0002-004 Y-shaped brass in-line filter F 1/2"
- Art.F96-0100-404 N.2 nipple 1/2" 1/2"BSP
- Art.906-0404-015 1SC 1/2" hose M-F l 1,5 m
- Art.906-0424-020 1SC 1/2" hose F-F l 2,0 m
- Art.A28-1274-094 Ø 30 suction tube 940 mm length with threaded ring



042-1550-055	12,500	0,040	3
--------------	--------	-------	---

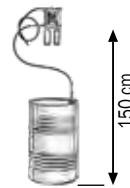

042-1550-055

## Art. 042-1550-110

wall-fixing kit diaphragm pumps mod. A110 for transfer oil

Equipped with:

- Art.028-A110-AB1 Diaphragm pump of aluminium **R=1:1** 3/4" 110 l/min
- Art.025-1266-001 Wall-fixing bracket
- Art.R34-0002-005 Y-shaped brass in-line filter F 3/4"
- Art.F96-0100-505 N.2 nipple 3/4" 3/4"BSP
- Art.F96-0100-605 Reduced nipple 1"- 3/4"BSP
- Art.906-0505-030 1SC 3/4" hose M-F l 3,0 m
- Art.906-0525-020 1SC 3/4" hose F-F l 2,0 m
- Art.093-5200-000 Aluminium manual nozzle MC80



042-1550-110	17,800	0,063	3
--------------	--------	-------	---

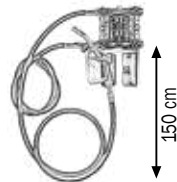

042-1550-110

## Art. 042-1550-170

wall-fixing kit diaphragm pumps mod. A170 for transfer oil

Equipped with:

- Art.028-A170-AB1 Diaphragm pump of aluminium **R=1:1** 1" 170 l/min
- Art.025-1266-002 Wall-fixing bracket
- Art.R34-0002-006 Y-shaped brass in-line filter F 1"
- Art.F96-0100-606 N.2 nipple 1"- 1"BSP
- Art.F96-0100-605 Reduced nipple 1"- 3/4" BSP
- Art.F96-0300-605 Plug reduction M1"- F 3/4" BSP
- Art.906-0505-030 1SC 3/4" hose M-F l 3,0 m
- Art.906-0626-020 1SC 1" hose F-F l 2,0 m
- Art.093-5200-000 Aluminium manual nozzle MC80



042-1550-170	29,800	0,082	3
--------------	--------	-------	---

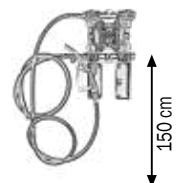

042-1550-170

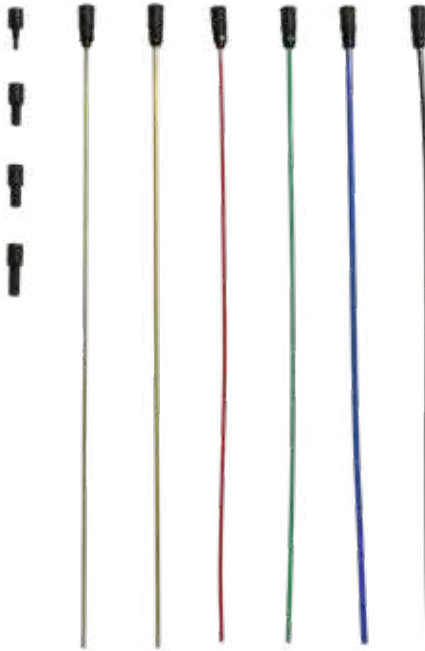

044-1479-000

**Art. 044-1479-000**

Set 10 standard probes supplied with the oil aspirators

Composed by:

- Art. 044-1480-000** Connection suitable for Volkswagen – AUDI engine-incorporated probes
  - Art. 044-1481-000** Connection suitable for BMW engine-incorporated probes
  - Art. 044-1481-B00** Connection suitable for JTD – FIAT engine-incorporated probes
  - Art. 044-1481-C00** Connection suitable for Citroën-Peugeot engine-incorporated probes
  - Art. 044-1482-000** Flexible probe Ø 5 mm 800 mm
  - Art. 044-1483-000** Flexible probe Ø 6 mm 800 mm
  - Art. 044-1484-000** Flexible probe Ø 7 mm 1000 mm
  - Art. 044-1485-000** Flexible probe Ø 8 mm 800 mm
  - Art. 044-1488-000** Metallic probe Ø 5 mm 800 mm
  - Art. 044-1489-000** Metallic probe Ø 6 mm 800 mm
- The same probes are available as single items

Probes on request

- Art. 044-1490-000** Flexible probe Ø 8 mm 1000 mm
- Art. 044-1491-000** Flexible probe Ø 5 mm 1200 mm
- Art. 044-1492-000** Flexible probe Ø 6 mm 1200 mm
- Art. 044-1493-000** Flexible probe Ø 7 mm 1200 mm
- Art. 044-1494-000** Flexible probe Ø 8 mm 1200 mm
- Art. 044-1497-000** Flexible probe Ø 8 mm 1500 mm
- Art. 044-1498-000** Flexible probe Ø 12 mm 800 mm
- Art. 044-1500-000** STAINLESS STEEL probe Ø 8 mm 800 mm
- Art. 044-1501-000** STAINLESS STEEL probe Ø 10 mm 800 mm
- Art. 044-1502-000** STAINLESS STEEL probe Ø 12 mm 800 mm
- Art. 044-1505-000** Wall-fixing support for probes
- Art. 044-1479-A00** Connection for probes with lever valve



044-1505-000



044-1479-A00

For the recovery by fall of exhausted oil of the engine, the transmission and the differential of motor-vehicles on lifts.

The basin is equipped with a grate of support to drip the substituted filters, and it can be regulated according to the height.

Exhausted oil drain units suitable for the fall recovery of oils of motors, transmissions and differential gears for lorries on pits

Wheeled exhausted oil drain units for floor suitable for the fall recovery of oils of motors, transmissions and differential gears of lorries.

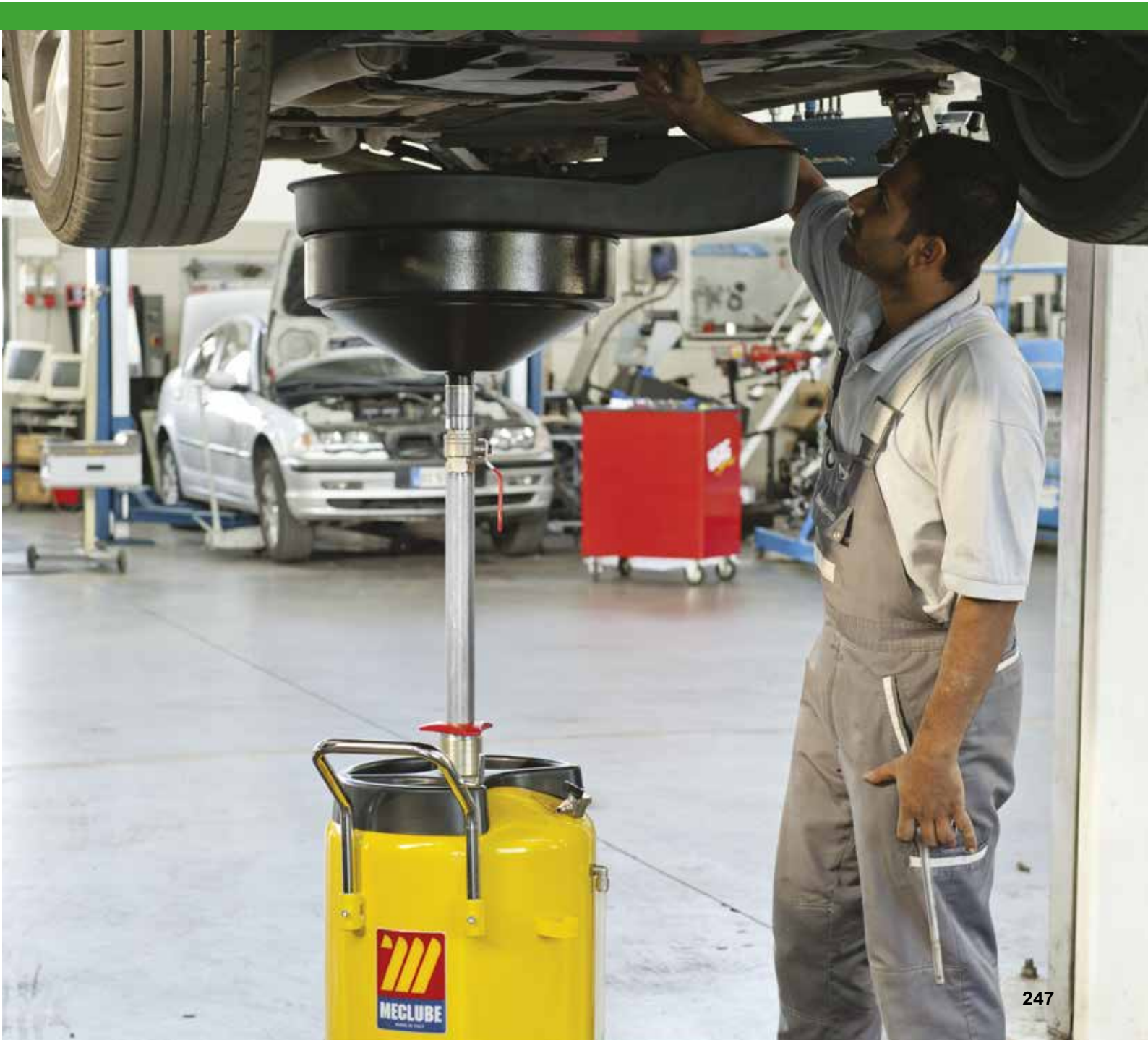

For the recovery by fall of exhausted oil of the engine, the transmission and the differential of motor-vehicles on lifts. The basin is equipped with a grate of support to drip the substituted filters, and it can be regulated according to the height.





DRAIN UNITS

page 250



WHEELED DRAIN UNITS

page 251



RECOVERY BASINS

page 251



DRAIN UNITS FOR PITS

page 252



EXHAUSTED OIL DRAIN UNIT FOR PITS  
WITH PANTOGRAPH

page 253



DRAIN UNITS FOR GROUND

page 254



TANK FOR THE COLLECTION OF EXHAUSTED  
MOTOR OIL "Ecoil Duplex"

page 256



**045-1462-000**

## Art. 045-1462-000

### Exhausted oil drain unit 65 l

Tank capacity 65 l with level indicator  
Abs tool holder basin with 3 sections  
Recovery basin capacity 15 l  
with breakwater grate to drip the substituted oil filters  
Pneumatic air emptying (max pressure 0,5 bar)



**045-1462-000** 26,900 0,220 1

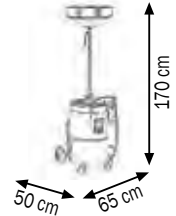

## Art. 045-1460-000

### Exhausted oil drain unit 90 l

Tank capacity 90 l with level indicator  
Abs tool holder basin with 3 sections  
Recovery basin capacity 20 l  
with ergonomic and **360° swivelling** abs funnel  
with breakwater grate to drip the substituted oil filters  
Pneumatic air emptying (max pressure 0,5 bar)

## Art. 045-1460-E00

### Exhausted oil drain unit 90 l

Composed like Art.045-1460-000 but with:  
Recovery basin capacity 15 l



**045-1460-000** 33,500 0,240 2

**045-1460-E00** 29,500 0,240 1

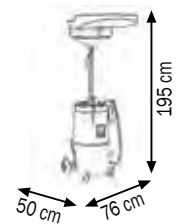

**045-1460-000**

## Art. 045-1465-000

### Exhausted oil drain unit 120 l

Tank capacity 120 l with level indicator  
Abs tool holder basin with 3 sections  
Recovery basin capacity 20 l  
with ergonomic and **360° swivelling** abs funnel  
with breakwater grate to drip the substituted oil filters  
Pneumatic air emptying (max pressure 0,5 bar)



**045-1465-000** 33,800 0,310 2

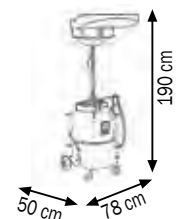

**045-1465-000**

Technical data		045-1462-000	045-1460-000	045-1460-E00	045-1465-000
Basin dimensions	mm	ø 450	760X705	ø 450	760X705
Minimum height	mm	1000	1200	1200	1200
Maximum height	mm	1700	1850	1850	1850
Emptying hose length	mm	2	2	2	2

For the recovery by fall of exhausted oil of the engine, the transmission and the differential of motor-vehicles on lifts.

The basin is equipped with a grate of support to drip the substituted filters, and it can be regulated according to the height.

**Warning:** It is not possible to recovery brake oils, fuels, inflammable and corrosive liquids.

## Art. 045-1470-000

Wheeled exhausted oil drain unit suitable for drums 50–60 l

Composed by:

Art.030-1395-000 4-wheels trolley

Art.049-1477-000 Metal basin 15 l

with breakwater grate to drip the substituted oil filters

Art.025-1260-000 2" G threaded ring for drum connection



045-1470-000	21,100	0,111	2
--------------	--------	-------	---

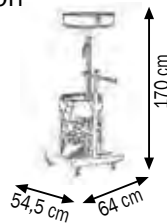

045-1470-000

## Art. 045-1475-000

Wheeled exhausted oil drain unit suitable for barrels 180–220 l

Composed by:

Art.030-1400-000 4-wheels trolley

Art.049-1478-000 Metal basin 20 l

with ergonomic and 360° swivelling abs funnel

with breakwater grate to drip the substituted oil filters

Art.025-1262-000 2" G threaded ring for drum connection



045-1475-000	46,500	0,209	2
--------------	--------	-------	---

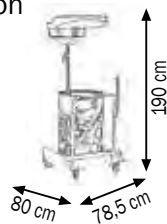

049-1475-000

## Art. 049-1477-000

15 l recovery basin

Composed by:

Metal basin 15 l

with breakwater grate to drip the substituted oil filters

Ø 30 L 750 mm hose with 3/4" G valve

2" G threaded ring for drum connection

## Art. 049-1478-000

20 l recovery basin

Composed by:

Metal basin 20 l

with ergonomic and 360° swivelling abs funnel

with breakwater grate to drip the substituted oil filters

Ø 42 L 750 mm hose with 1" G valve

2" G threaded ring for drum connection



049-1477-000	7,500	0,049	2
--------------	-------	-------	---

049-1478-000	9,500	0,052	2
--------------	-------	-------	---

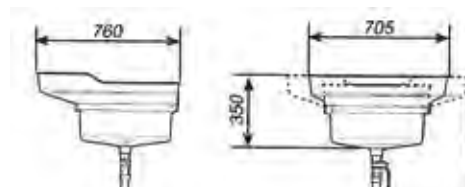

049-1477-000

049-1478-000

For the recovery by fall of exhausted oil of the engine, the transmission and the differential of motor-vehicles on lifts.

The basin is equipped with a grate of support to drip the substituted filters, and it can be regulated according to the height.

**Warning:** It is not possible to recovery brake oils, fuels, inflammable and corrosive liquids.

## Art. 046-1457-000

Exhausted oil drain unit for pits 90 l

Tank capacity 90 l

Equipped with:

Breakwater grate on the base of the tank

Breakwater grate to drip the substituted oil filters

Adjustable wheeled supports (min 800 – max 1200 mm)

F 3/4" G exhaust ball valve



**046-1457-000**



**046-1457-000** 30,200 0,152 1

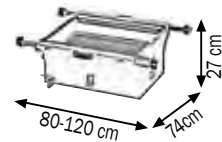

## Art. 046-1457-G00

Exhausted oil drain unit for pits 120 l

Tank capacity 120 l

Equipped with:

Breakwater grate on the base of the tank

Breakwater grate to drip the substituted oil filters

Adjustable wheeled supports (min 800 – max 1200 mm)

F 3/4" exhaust ball valve



**046-1457-G00**



**046-1457-G00** 38,400 0,234 1



## Art. 046-1457-GP0

Exhausted oil drain unit for pits 120 l

With emptying pump

Tank capacity 120 l

Equipped with:

Art.020-1165-000 Air-operated oil pump **ratio=1:1**

Breakwater grate on the base of the tank

Breakwater grate to drip the substituted oil filters

Adjustable wheeled supports (min 800 – max 1200 mm)

F 3/4" G exhaust ball valve

Art.F96-0500-004 Female quick disconnect coupling 1/2" G

Art.F96-0502-004 Male quick disconnect coupling 1/2" G



**046-1457-GP0**



**046-1457-GP0** 44,000 0,234 1



Exhausted oil drain units suitable for the fall recovery of oils of motors, transmissions and differential gears of lorries on pits. The tank is equipped with breakwater and anti-reflux grate ideal as a support to drip the substituted oil filters.

The recovery exhausted oil can be transferred from the drain unit to the tank collection through an emptying pump connected to the fix system or directly assembled on the tank.

## Art. 047-1460-P00

Exhausted oil drain unit for pits with pantograph

Equipped with:

Recovery basin capacity 30 l 700X300X200 mm with double lid equipped with handles

Art.020-1198-000 Air-operated oil pump ratio=5:1 28 l/min

Pressure regulators with lubricating filter and pressure gauge

Oil filter connection F-F 1.1/4"

Pneumatic cylinder for tank lifting

Lever to operate the pneumatic cylinder

Suction and delivery hose kit

Female quick disconnect coupling 3/4"

Male quick disconnect coupling 3/4"

Nylon support wheel Ø 125

2 trolleys with 4 ball wheels for rail C40



047-1460-P00



047-1460-P00	104,200	1,00	1
--------------	---------	------	---



## ACCESSORIES

### Art. 047-1465-040

Guide rail for drain unit 40X40X2,5 l 4,0 m



047-1465-040

### Art. 047-1466-040

4-wheel trolley for guide rail C 40



047-1466-040

### Art. 047-1467-040

Rail coupling support bracket C40



047-1467-040

### Art. 047-1468-040

Limit switch bracket for rail C40



047-1468-040

### Art. 047-1469-040

Support bracket rail C40 for ceiling fixing



047-1469-040



047-1465-040	10,100	0,010	1
047-1466-040	0,490	0,007	1
047-1467-040	0,740	0,007	1
047-1468-040	0,270	0,007	1
047-1469-040	0,560	0,007	1

## WHEELED EXHAUSTED OIL DRAIN UNITS FOR FLOOR



**047-1459-000**

### Art. 047-1459-000

#### Wheeled exhausted oil drain unit 60 l

Tank capacity 60 l

Equipped with:

Breakwater grate on the base of the tank

Breakwater grate to drip the substituted oil filters

2 swiveling wheels Ø 80 mm

2 fixed wheels Ø 100 mm

F 3/4" G exhaust ball valve



**047-1459-000** 25,600 0,145 1

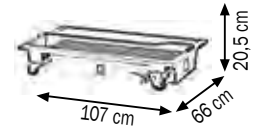

**047-1459-G00**

### Art. 047-1459-G00

#### Wheeled exhausted oil drain unit 120 l

Tank capacity 120 l

Equipped with:

Breakwater grate on the base of the tank

Breakwater grate to drip the substituted oil filters

2 swiveling wheels Ø 80 mm

2 fixed wheels Ø 100 mm

F 3/4" G exhaust ball valve



**047-1459-G00** 40,900 0,203 1

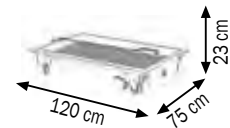

**047-1459-GP0**

### Art. 047-1459-GP0

#### Wheeled exhausted oil drain unit 120 l

##### With emptying pump

Tank capacity 120 l

Equipped with:

Art.020-1165-000 Air-operated oil pump **ratio=1:1**

Breakwater grate on the base of the tank

Breakwater grate to drip the substituted oil filters

2 swiveling wheels Ø 80 mm

2 fixed wheels Ø 100 mm

F 3/4" G exhaust ball valve

Art.F96-0500-004 Female quick disconnect coupling 1/2" G

Art.F96-0502-004 Male quick disconnect coupling 1/2" G



**047-1459-GP0** 46,500 0,203 1

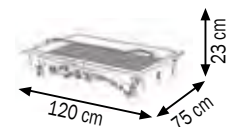

Exhausted oil wheeled drain units for floor suitable for the full recovery of oils of motors, transmissions and differential gears of lorries.

The tank is equipped with breakwater and anti-reflux grate ideal as a support to drip the substituted oil filters. The recovery exhausted oil can be transferred from the drain unit to the tank collection through an emptying pump connected to the fix system or directly assembled on the tank.

# WHEELED EXHAUSTED OIL DRAIN UNITS FOR FLOOR



## Art. 047-1459-200

### Wheeled exhausted oil drain unit 200 l

Tank capacity 200 l

Equipped with:

T-handle for handling

Breakwater grate on the base of the tank

Breakwater grate to drip the substituted oil filters

2 swiveling wheels Ø 180 mm (one is equipped with locking device)

2 fixed wheels Ø 180 mm

F 1" G exhaust ball valve



047-1459-200

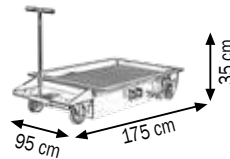

047-1459-200	84,200	0,650	1
--------------	--------	-------	---

## Art. 047-1459-2P0

### Wheeled exhausted oil drain unit 200 l

With emptying pump

Tank capacity 200 l

Equipped with:

Art.020-1165-000 Air-operated oil pump ratio=1:1

T-handle for handling

Breakwater grate on the base of the tank

Breakwater grate to drip the substituted oil filters

2 swiveling wheels Ø 180 mm (one is equipped with locking device)

2 fixed wheels Ø 180 mm

F 1" G exhaust ball valve

Art.F96-0500-004 Female quick disconnect coupling 1/2" G

Art.F96-0502-004 Male quick disconnect coupling 1/2" G



047-1459-2P0

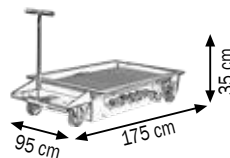

047-1459-2P0	90,300	0,650	1
--------------	--------	-------	---

Exhausted oil wheeled drain units for floor suitable for the full recovery of oils of motors, transmissions and differential gears of lorries.

The tank is equipped with breakwater and anti-reflux grate ideal as a support to drip the substituted oil filters.

The recovery exhausted oil can be transferred from the drain unit to the tank collection through an emptying pump connected to the fix system or directly assembled on the tank.



**049-1500-300**

## Art. 049-1500-300

Tank for the collection of exhausted Motor Oil "Ecoil"

Tank capacity: 300 l

Made of high density polyethylene  
Consisting of 2 tanks, one internal for containment  
an one external with a safety function  
In the upper part it is equipped with a large hatch  
with hinged lid, inside there's the perforated  
surface which serves as a filters' strainer  
Equipped with externally visible level indicator  
Monitoring light in the interspace  
Suitable for installation also outdoors  
Dimensions: A 820 X H 1080 mm



**049-1500-300** 30,00 0,60 1



**049-1500-500**

## Art. 049-1500-500

Tank for the collection of exhausted Motor Oil "Ecoil"

Tank capacity: 500 l

Made of high density polyethylene  
Consisting of 2 tanks, one internal for containment  
an one external with a safety function  
In the upper part it is equipped with a large hatch  
with hinged lid, inside there's the perforated  
surface which serves as a filters' strainer  
Equipped with externally visible level indicator  
Monitoring light in the interspace  
Suitable for installation also outdoors  
Dimensions: A 960 X H 1240 mm



**049-1500-500** 42,00 1,04 1



Filters' strainer compartment



Externally visible level indicator



Monitoring light in the interspace

The containers are made in compliance with LD 27/01/1992, n.95, and with DM n.392 of 16/05/1996, they also comply with the implementation of directives 75/439 / EEC and 87/10 / EEC relating to disposal of exhausted oils.

Equipment suitable for the nebulisation of low density lubricating oils, detergents, sterilizers, and so on. When they are filled with liquid for 3/4 of their capacity and air is put inside at 6-8 bar they work automatically without any continuous link to compressed air.

They are suitable for the washing of mechanical parts and items in general. The air-operated working at low pressure (max 0,5 bar) allows the washing with brush with continuous flux, or the washing of the items plunged in the liquid directly in the tank. The lid can be removed and so it is possible to work better.



Equipment suitable for the nebulisation of low density lubricating oils, detergents, sterilizers, and so on. When they are filled with liquid for 3/4 of their capacity and air is put inside at 6-8 bar they work automatically without any continuous link to compressed air.

They are suitable for the washing of mechanical parts and items in general. The air-operated working at low pressure (max 0,5 bar) allows the washing with brush with continuous flux, or the washing of the items plunged in the liquid directly in the tank. The lid can be removed and so it is possible to work better.





AISI 304-316 STAINLESS STEEL PRESSURE SPRAYERS

page 260



VARNISHED PRESSURE SPRAYERS

page 261



AISI 304-316 STAINLESS STEEL PRESSURE SPRAYERS WITH FOAMING DEVICE

page 262



VARNISHED PRESSURE SPRAYERS WITH FOAMING DEVICE

page 263



ACCESSORIES FOR PRESSURE SPRAYERS

page 264



LEATHER SQUEEZER

page 266



WASHING COLLECTOR

page 266



**050-1508-000**

## Art. 050-1508-000

**AISI 304 stainless steel pressure sprayer 16 l**

Tank capacity 16 l with lever indicator

Equipped with:

Art.053-1537-000 10 m RILSAN spring hose

Art.053-1541-000 Spray gun with 600 mm stainless steel pipe

Manometer with stainless steel case



<b>050-1508-000</b>	9,600	0,074	1
---------------------	-------	-------	---

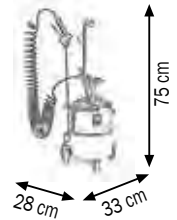

**050-1510-000**

## Art. 050-1510-000

**AISI 304 stainless steel pressure sprayer 24 l**

Tank capacity 24 l with lever indicator

Equipped with:

Art.053-1537-000 10 m RILSAN spring hose

Art.053-1541-000 Spray gun with 600 mm stainless steel pipe

Manometer with stainless steel case



<b>050-1510-000</b>	9,900	0,074	1
---------------------	-------	-------	---

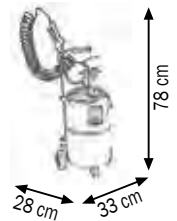

**050-1511-000**

## Art. 050-1511-000

**AISI 316 stainless steel pressure sprayer 24 l**

**Ideal for chemical products**

Tank capacity 24 l with lever indicator

Equipped with:

Art.053-1537-000 10 m RILSAN spring hose

Art.053-1541-000 Spray gun with 600 mm stainless steel pipe

Manometer with stainless steel case

**AISI 316 stainless steel connections**

**Viton seals**



<b>050-1511-000</b>	9,700	0,074	1
---------------------	-------	-------	---

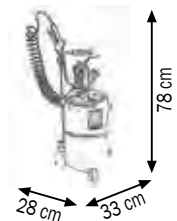

**050-1515-000**

## Art. 050-1515-000

**AISI 304 stainless steel pressure sprayer 50 l**

Tank capacity 50 l with lever indicator

Equipped with:

Art.053-1537-000 10 m RILSAN spring hose

Art.053-1541-000 Spray gun with 600 mm stainless steel pipe

Manometer with stainless steel case



<b>050-1515-000</b>	20,000	0,196	1
---------------------	--------	-------	---

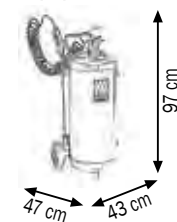

Equipment suitable for the nebulisation of low density lubricating oils, detergents, disinfectants, and so on. When they are filled with liquid for 3/4 of their capacity and air is put inside at 6-8 bar they work automatically without any continuous link to compressed air.

**ATTENTION! Do not use inflammable and corrosive liquids.**

## Art. 050-1520-000

### Varnished steel pressure sprayer 24 l

Tank capacity 24 l with lever indicator

Equipped with:

Art.053-1537-000 10 m RILSAN spring hose

Art.053-1541-000 Spray gun with 600 mm stainless steel pipe

050-1520-000	11,500	0,074	1

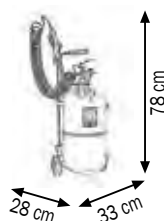

050-1520-000

## Art. 050-1525-000

### Varnished steel pressure sprayer 50 l

Tank capacity 50 l with lever indicator

Equipped with:

Art.053-1537-000 10 m RILSAN spring hose

Art.053-1541-000 Spray gun with 600 mm stainless steel pipe

050-1525-000	22,800	0,196	1

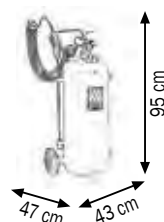

050-1525-000

## Art. 050-1530-000

### Varnished steel pressure sprayer 100 l

Tank capacity 100 l with lever indicator

Equipped with:

Art.053-1537-000 10 m RILSAN spring hose

Art.053-1542-000 Spray gun with 750 mm stainless steel pipe

050-1530-000	39,100	0,360	1

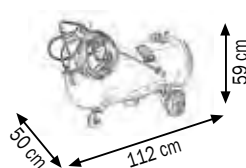

050-1530-000

Equipment suitable for the nebulisation of low density lubricating oils, detergents, disinfectants, and so on. When they are filled with liquid for 3/4 of their capacity and air is put inside at 6-8 bar they work automatically without any continuous link to compressed air.

**ATTENTION! Do not use inflammable and corrosive liquids.**

## STAINLESS STEEL PRESSURE SPRAYERS WITH FOAMING DEVICE



**051-1512-000**

### Art. 051-1512-000

**AISI 304 stainless steel pressure sprayer 24 l**  
**With foaming device**

Tank capacity 24 l with lever indicator

Equipped with:

Art.053-1538-000 8x13 8 m length pvc hose

Art.053-1541-000 Spray gun with 600 mm stainless steel pipe

Art.053-1552-000 Thermoplastic fan nozzle for foaming 16,8 l/min

Art.053-1554-000 Foaming coupler super

Manometer with stainless steel case



**051-1512-000** 11,200 0,074 1

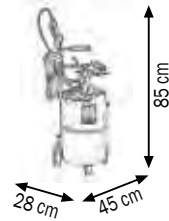

**051-1513-000**

### Art. 051-1513-000

**AISI 316 Stainless steel pressure sprayer 24 l**

**With foaming device**

**Ideal for corrosive liquids and chemical products**

Tank capacity 24 l with lever indicator

Equipped with:

Art.053-1538-000 8x13 8 m length pvc hose

Art.053-1541-000 Spray gun with 600 mm stainless steel pipe

Art.053-1552-000 Thermoplastic fan nozzle for foaming 16,8 l/min

Art.053-1554-000 Foaming coupler super

Manometer with stainless steel case

**AISI 316 stainless steel connections**

**Viton seals**



**051-1513-000** 10,700 0,074 1

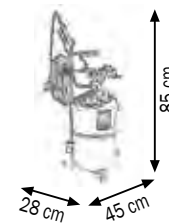

**051-1517-000**

### Art. 051-1517-000

**AISI 304 stainless steel pressure sprayer 50 l**

**With foaming device**

Tank capacity 50 l with lever indicator

Equipped with:

Art.053-1538-000 8x13 8 m length pvc hose

Art.053-1541-000 Spray gun with 600 mm stainless steel pipe

Art.053-1552-000 Thermoplastic fan nozzle for foaming 16,8 l/min

Art.053-1554-000 Foaming coupler super

Manometer with stainless steel case



**051-1517-000** 21,000 0,196 1

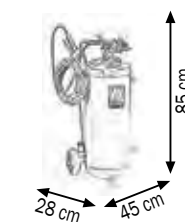

Equipment suitable for the nebulisation of detergents with foaming device. When they are filled with liquid for 3/4 of their capacity and air is put inside at 6-8 bar they work automatically without any continuous link to compressed air.

**ATTENTION! Do not use inflammable and corrosive liquids.**

# VARNISHED STEEL PRESSURE SPRAYERS WITH FOAMING DEVICE



## Art. 051-1522-000

Varnished steel pressure sprayer 24 l  
With foaming device

Tank capacity 24 l with lever indicator  
Equipped with:

- Art.053-1538-000 8x13 8 m length pvc hose
- Art.053-1541-000 Spray gun with 600 mm stainless steel pipe
- Art.053-1552-000 Thermoplastic fan nozzle for foaming 16,8 l/min
- Art.053-1554-000 Foaming coupler super



051-1522-000	12,400	0,074	1
--------------	--------	-------	---

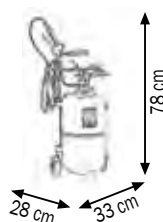

051-1522-000

## Art. 051-1527-000

Varnished steel pressure sprayer 50 l  
With foaming device

Tank capacity 50 l with lever indicator  
Equipped with:

- Art.053-1538-000 8x13 8 m length pvc hose
- Art.053-1541-000 Spray gun with 600 mm stainless steel pipe
- Art.053-1552-000 Thermoplastic fan nozzle for foaming 16,8 l/min
- Art.053-1554-000 Foaming coupler super



051-1527-000	23,900	0,196	1
--------------	--------	-------	---

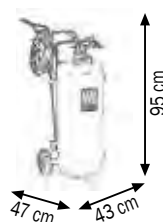

051-1527-000

## Art. 051-1532-000

Varnished steel pressure sprayer 100 l  
With foaming device

Tank capacity 100 l with lever indicator  
Equipped with:

- Art.053-1538-000 8x13 8 m length pvc hose
- Art.053-1542-000 Spray gun with 750 mm stainless steel pipe
- Art.053-1552-000 Thermoplastic fan nozzle for foaming 16,8 l/min
- Art.053-1554-000 Foaming coupler super



051-1532-000	39,700	0,360	1
--------------	--------	-------	---

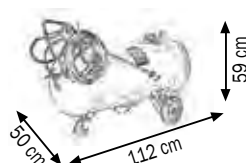

051-1532-000

Equipment suitable for the nebulisation of detergents with foaming device. When they are filled with liquid for 3/4 of their capacity and air is put inside at 6-8 bar they work automatically without any continuous link to compressed air.

**ATTENTION! Do not use inflammable and corrosive liquids.**



053-1537-000

**Art. 053-1537-000**  
10 m length RILSAN spring hose 6X8  
1/4" M fitting



053-1538-000

**Art. 053-1538-000**  
20 bar 8x13 8 m length pvc hose  
Bayonet connection



053-1541-000

**Art. 053-1541-000**  
Spray gun with 600 mm stainless steel pipe  
Equipped with:  
Stainless steel pipe 600 mm length  
Gun with body P.P. reinforced with F.V  
Stainless steel AISI 316 ball  
Stainless steel internal parts and viton seals  
110° fan nozzle Ø hole 1,1  
50 Mesh stainless steel cup filter

053-1542-000

**Art. 053-1542-000**  
Spray gun with 750 mm stainless steel pipe  
Composed like Art.053-1541-000 but with:  
Stainless steel pipe 750 mm

053-1544-000

**Art. 053-1544-000**  
Spray gun with 900 mm stainless steel pipe  
Composed like Art.053-1541-000 but with:  
Stainless steel pipe 900 mm

053-1545-000

**Art. 053-1545-000**  
Telescopic spray gun with stainless steel pipe from 1 m to 2 m  
Composed like Art.053-1541-000 but with:  
Adjustable stainless steel telescopic spray  
gun from 1 m min to 2 m max length



024-1232-P65

**Art. 024-1232-P65**  
Water dispensing nozzle RB65 blu 1/2"  
Adjustable jet brass shaft  
Brass swivel joint F1/2" G  
Pressure max 24 bar  
Temperature max 90°C

**Art. 053-1546-000**

110° thermoplastic (POM) fan nozzle Ø hole 0,9  
Yellow color



053-1546-000

**Art. 053-1547-000**

110° thermoplastic (POM) fan nozzle Ø hole 1,1  
Blue color



053-1547-000

**Art. 053-1548-000**

110° thermoplastic (POM) fan nozzle Ø hole 1,3  
Red color



053-1548-000

**Art. 053-1550-000**

110° thermoplastic (POM) fan nozzle Ø hole 1,8  
White color



053-1550-000

**Art. 053-1552-000**

Thermoplastic fan nozzle for foaming  
Delivery capacity 3 bar 16,8 l/min  
Brown color



053-1552-000

**Art. 053-1553-000**

Stainless steel fan nozzle for foaming  
Delivery capacity 3 bar 9,8 l/min



053-1553-000

**Art. 053-1554-000**

Thermoplastic super foaming coupler  
Red color



053-1554-000

**Art. 053-1555-000**

Stainless steel cup filter 50 Mesh



053-1555-000

**Art. 053-1560-000**

Thermoplastic nozzle holder protection fitting  
Red color



053-1560-000

## Art. 054-1556-000

Wall-mounted leather squeezer

With galvanized support angle brackets



054-1556-000



054-1556-000 8,700 0,040 1

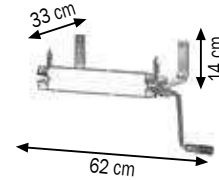

These articles are essential in car washings in order to make it easy and improve the drying of vehicles with leather or synthetics clothes.



055-1560-000

## Art. 055-1560-000

Washing collector with wheeled tank 65 l

Collector capacity 50 l with removable lid

Tank capacity 65 l

Max pressure use 0,5 bar

Equipped with:

Filter and grate of decantation

Blowing nozzle with spiral hose

Brush with nylon bristles with 1,5 m length pvc hose



055-1560-000 43,100 0,300 2

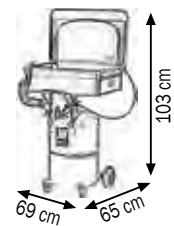

057-1563-000

## Art. 057-1563-000

Brush with nylon bristles for washing collector

For the washing of mechanical parts and items in general. The air-operated working at low pressure (max 0,5 bar) allows the washing with brush with continuous flux, or the washing of the items plunged in the liquid directly in the tank. For a correct use, spill 48-52 l of detergent liquid. The lid can be removed and so it is possible to work better.

### WARNING!

Do not use inflammable or corrosive liquids or substances that emanate toxic vapors.

Use exclusively specific chemical products for the washing of mechanical parts, to use only according to regulation furnished by the manufacturer.





They are suitable for service stations and garages, for checking and re-establishing the tyre pressure through the inflating valve and discharge with lever in the version with automatic charge, with the inflating gun in the version with manual charge.



They are suitable for service stations and garages, for checking and re-establishing the tyre pressure through the inflating valve and discharge with lever in the version with automatic charge, with the inflating gun in the version with manual charge.





TYRE INFLATORS WITH AUTOMATIC CHARGE

page 272



TYRE INFLATORS WITH MANUAL CHARGE

page 273



WHEELED TYRE INFLATORS WITH MANUAL CHARGE

page 273



SWIVELLING CLOSED HOSE REEL TO INFLATE TYRES

page 274



ACCESSORIES FOR TYRE INFLATORS

page 274



**060-1582-000**

### Art. 060-1582-000

Approved CEE tyre inflator 12 l with automatic charge

Tank capacity 12 l

Equipped with:

Approved gauge Ø 80 with scale 0-10 bar

1,20 m rubber hose with double clip-on connector

Art.063-1586-000 Automatic charger



060-1582-000 11,100 0,074 1

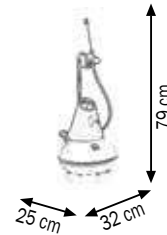

### Art. 060-1583-000

Approved CEE portable tyre inflator 12 l with automatic charge with support

Tank capacity 12 l

Equipped with:

Approved gauge Ø 80 with scale 0-10 bar

1,20 m rubber hose with double clip-on connector

Support with automatic charger



060-1583-000 13,100 0,136 1

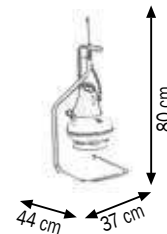

**060-1583-000**

### Art. 063-1586-000

Automatic charger for tyre inflators

Connection M 1/2" G



**063-1586-000**

Technical data		060-1582-000	060-1583-000
Max pressure tank	bar	10	10
Max working pressure	bar	8	8
Calibrated safety	bar	10	10
Approved CE Ø 80 gauge	bar	0-10	0-10

They are suitable for service stations and garages, for checking and re-establishing the tyre pressure through the inflating and deflating valve lever. They have automatic charge in order to be ready for use. The operation of inflation and deflation of the tyres will be carried out through a unique three positions lever. To have the tyre inflator ready for use it is enough to put it on the automatic charger installed on the line of the compressed air.

**NOTE: APPROVED FOR PUBLIC USE**

## Art. 061-1590-000

Portable tyre inflator with manual charge 12 l

Tank capacity 12 l

Equipped with:

Reading gauge Ø 50 mm 0-10 bar

Art.063-1596-000 5 m RILSAN spring hose

Art.063-1597-000 Inflating gun with Ø 63 gauge

## Art. 061-1591-000

Portable tyre inflator with manual charge 12 l

Like art.061-1590-000 but with:

Art.063-1598-A00 Michelin approved inflating gun with Ø 80 gauge



061-1591-000

## Art. 061-1594-000

Wheeled tyre inflator with manual charge 24 l

Tank capacity 24 l

Equipped with:

Reading gauge Ø 80 mm 0-10 bar

Art.063-1596-000 5 m RILSAN spring hose

Art.063-1597-000 Inflating gun with Ø 63 gauge

## Art. 061-1595-000

Wheeled tyre inflator with manual charge 24 l

Like art.061-1594-000 but with:

Art.063-1598-A00 Michelin approved inflating gun with Ø 80 gauge



061-1595-000

061-1590-000	7,550	0,081	1	
061-1591-000	7,800	0,081	1	
061-1594-000	11,500	0,074	1	
061-1595-000	11,600	0,074	1	

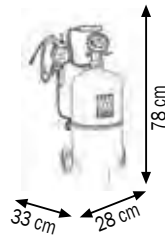
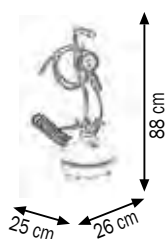

Technical data		061-1590-000	061-1591-000	061-1594-000	061-1595-000
Max pressure tank	bar	10	10	10	10
Max working pressure	bar	8	8	8	8
Calibrated safety valve	bar	10	10	10	10
Approved CE Ø 80 gauge	bar	0-10	0-10	0-10	0-10

They are necessary in service stations and garages, for checking and re-establishing the tyre pressure through the inflating gun with gauge scale 0-10 bar.



063-1596-000

**Art. 063-1596-000**  
5 m RILSAN spring hose  
1/4 "M bayonet fitting connection



063-1597-000

**Art. 063-1597-000**  
Inflating gun with Ø 63 gauge  
Scale 0-10 bar + 0-140 PSI  
Rubber gauge-cover  
Flexible hose 0,40m with coupler



063-1598-000

**Art. 063-1598-000**  
Approved inflating gun with Ø 80 gauge,  
approved to European Directive 2011/17/UE  
Scale 0-10 bar  
Rubber gauge-cover  
Flexible hose 0,40m with coupler



063-1598-A00

**Art. 063-1598-A00**  
Michelin approved inflating eurodainu gun with Ø 80 gauge  
approved to European Directive 2011/17/UE  
Scale 0,7-12 bar/PSI  
Rubber gauge-cover  
Flexible hose 1,50m with coupler



063-1599-000

**Art. 063-1599-000**  
Angle head connector for twin tyres  
Flexible hose 0,80m with coupler



063-1581-000

**Art. 063-1581-000**  
Swiveling closed hose reel for inflating tyres  
Equipped with:  
Art.075-4301-211 Swiveling closed hose reel with hose PU 8x13 20 bar 11 m  
Art.063-1598-A00 Michelin approved inflating eurodainu gun with Ø 80 CEE gauge

It is equipped with a wall-fixing bracket which makes the wall fixing easier. The connection of the hose reel to the wall-fixing bracket is very fast and it allows a quick connection and disconnection. The continuous connection to the compressed air system makes the system of inflation ready to use.



063-1581-000 13,800 0,026 1

# AUTOMATIC HOSE REELS

Our automatic hose reels with spring, fixed or swivelling, of varnished steel, stainless steel AISI 304 or motorized hydraulic, pneumatic and electric are suitable for flexible hoses for the delivery of compressed air, water, oil or similar, grease, diesel, gasoline, antifreeze, windscreen, AdBlue® and food products. They allow to unroll only the necessary hose length, improving their functionality. The rewinding of the hose is fast and safe and allows to have a tidy workplace. You always have a ready-to-use equipment that grant to all the staff to work safely.



# HOSE REELS INDEX

## FIXED/SWIVELLING AUTOMATIC HOSE REELS IN PAINTED STEEL WITH HOSE



- AIR-WATER	20 - 28 bar	page 278
- WATER 150 °C	200 - 400 bar	page 282
- OIL AND SIMILAR	88 - 180 bar	page 286
- GREASE	275 - 400 bar	page 288
- ANTIFREEZE-WINDSCREEN-AdBlue®	20 bar	page 290
- DIESEL AND GASOLINE	10 - 16 bar	page 292

## FIXED/SWIVELLING AUTOMATIC HOSE REELS IN PAINTED STEEL



- FIXED AND SWIVELLING WITHOUT HOSE	page 296
-------------------------------------	----------

## FIXED/SWIVELLING AUTOMATIC HOSE REELS IN STAINLESS STEEL WITH HOSE



- AIR-WATER	20 - 28 bar	page 298
- WATER 150 °C	200 - 400 bar	page 302
- ANTIFREEZE-WINDSCREEN-AdBlue®	20 bar	page 306
- DIESEL AND GASOLINE	10 - 16 bar	page 308
- FOOD QUALITY FDA 120 °C	15 bar	page 312

## FIXED/SWIVELLING AUTOMATIC HOSE REELS IN STAINLESS STEEL



- FIXED AND SWIVELLING WITHOUT HOSE	page 314
-------------------------------------	----------

## AUTOMATIC CABLE REELS WITH ELECTRIC CABLE



- CABLE REELS WITH ELECTRIC CABLE	-	page 316
- CABLE REELS WITH PORTABLE LAMP	-	page 317
- EARTHING CABLE REEL	-	page 318

## FIXED/SWIVELLING CLOSED HOSE REELS IN PAINTED STEEL WITH HOSE



- AIR-WATER	10 - 28 bar	page 319
- WATER 150 °C	200 - 400 bar	page 320
- OIL AND SIMILAR	160 - 180 bar	page 322
- GREASE	330 - 400 bar	page 322
- ANTIFREEZE-WINDSCREEN-AdBlue®	20 bar	page 322

## FIXED/SWIVELLING CLOSED HOSE REELS IN STAINLESS STEEL WITH HOSE



- AIR-WATER	28 bar	page 324
- WATER 150 °C	200 - 400 bar	page 324

## FIXED MANUAL HOSE REELS IN PAINTED STEEL



- AIR-WATER	20 - 28 bar	page 328
- WATER 150 °C	200 - 400 bar	page 329
- OIL AND SIMILAR	88 - 180 bar	page 330
- GREASE	275 - 400 bar	page 331
- DIESEL	10 bar	page 332

# HOSE REELS INDEX

## FIXED MANUAL HOSE REELS IN STAINLESS STEEL

- AIR-WATER	20 - 28 bar	page 333
- WATER 150 °C	200 - 400 bar	page 334
- OIL AND SIMILAR	88 - 180 bar	page 335
- GREASE	275 - 400 bar	page 336
- DIESEL	10 bar	page 337
- ANTIFREEZE-WINDSCREEN-AdBlue®	20 bar	page 338



## AUTOMATIC HEAVY - DUTY HOSE REELS IN PAINTED STEEL WITH HOSE

- AIR-WATER	20 - 28 bar	page 340
- WATER 150 °C	200 - 400 bar	page 341
- OIL AND SIMILAR	88 - 180 bar	page 343
- GREASE	275 - 400 bar	page 344
- ANTIFREEZE-WINDSCREEN-AdBlue®	20 bar	page 345
- DIESEL AND GASOLINE	10 - 16 bar	page 346



## AUTOMATIC HEAVY - DUTY HOSE REELS IN STAINLESS STEEL WITH HOSE

- AIR-WATER	20 - 28 bar	page 348
- WATER 150 °C	200 - 400 bar	page 349
- ANTIFREEZE-WINDSCREEN-AdBlue®	20 bar	page 351
- DIESEL AND GASOLINE	10 - 16 bar	page 352



## AUTOMATIC INDUSTRIAL HOSE REELS WITH SPRIN Mod. FA-600

- AIR-WATER-OIL AND SIMILARI-DIESEL	10 - 250 bar	page 355
-------------------------------------	--------------	----------



## MOTORIZED INDUSTRIAL HOSE REELS IN PAINTED STEEL Mod. FE-600

- MOTORIZED 12 - 24 - 115 - 230V ELECTRIC	20 - 400 bar	page 358
- MOTORIZED HYDRAULIC	20 - 400 bar	page 362
- MOTORIZED PNEUMATIC	20 - 400 bar	page 363
- MANUAL WITH CRANK	20 - 400 bar	page 364
- ACCESSORIES FOR FE-600	-	page 365



## MOTORIZED INDUSTRIAL HOSE REELS IN PAINTED STEEL Mod. FE-700

- MOTORIZED 12 - 24 - 115 - 230V ELECTRIC	20 - 400 bar	page 368
- MOTORIZED HYDRAULIC	20 - 400 bar	page 372
- MOTORIZED PNEUMATIC	20 - 400 bar	page 373
- ACCESSORIES FOR FE-700	-	page 374



## ACCESSORIES FOR HOSE REELS

- PANEL SUPPORT FOR HOSE REELS	page 376
- VARNISHED ROTARY SUPPORT	page 377
- DIRECTIONAL BRACKETS	page 378
- SWIVELLING JOINTS AND CONNECTIONS	page 379
- RUBBER HOSE STOPS	page 382
- HOSES FOR HOSE REELS	page 382



# FIXED AUTOMATIC HOSE REELS IN PAINTED STEEL FOR AIR-WATER 20 bar

Equipped with:

- Blue polyurethane ether-based hoses
- Nickel-plated brass or galvanized steel connections
- Brass 90° swivelling joint
- Viton® seals



**F-400**

Article	L. hose	Ø hose	Max pressure	Inlet-Outlet
070-1201-300	without hose	-	-	F1/2"-M3/8"BSP
070-1201-400	without hose	-	-	F1/2"-M1/2"BSP
070-1201-215	15 m	8x12	20 bar	F1/2"G-M1/4"G gir.
070-1201-220	20 m	8x12	20 bar	F1/2"G-M1/4"G gir.
070-1201-310	10 m	10x14	20 bar	F1/2"-M3/8"BSP
070-1201-315	15 m	10x14	20 bar	F1/2"-M3/8"BSP
070-1201-410	10 m	13x19	20 bar	F1/2"-M1/2"BSP



**F-460**

Article	L. hose	Ø hose	Max pressure	Inlet-Outlet
070-1301-300	without hose	-	-	F1/2"-M3/8"BSP
070-1301-400	without hose	-	-	F1/2"-M1/2"BSP
070-1301-320	20 m	10X14	20 bar	F1/2"-M3/8"BSP
070-1301-415	15 m	13X19	20 bar	F1/2"-M1/2"BSP
070-1301-418	18 m	13X19	20 bar	F1/2"-M1/2"BSP



**F-550**

Article	L. hose	Ø hose	Max pressure	Inlet-Outlet
070-1401-400	without hose	-	-	F1/2"-M1/2"BSP
070-1401-420	20 m	13X19	20 bar	F1/2"-M1/2"BSP
070-1401-425	25 m	13X19	20 bar	F1/2"-M1/2"BSP

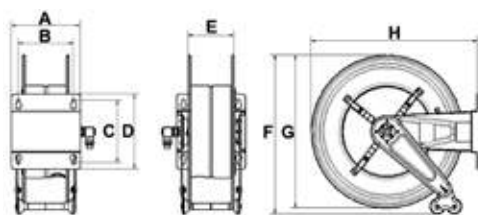

## OVERALL DIMENSIONS FIXED VERSION

Mod.	A	B	C	D	E	F	G	H	Kg	m³	W³
F-400	158	120	168	192	95	460	400	435	15,90<17,90	0,084	1
F-460	158	120	168	192	95	490	460	490	17,40<20,74	0,094	1
F-550	200	150	225	270	120	590	550	600	23,50<28,00	0,130	1

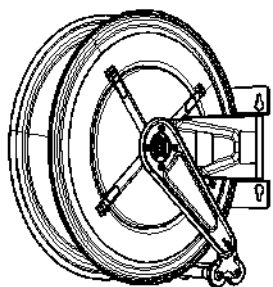

Wall application with internal output hose

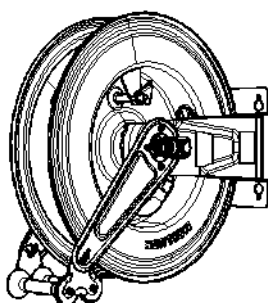

Wall application with external output hose

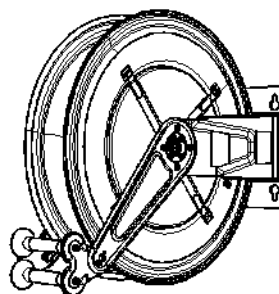

Wall and ceiling application with frontal output hose

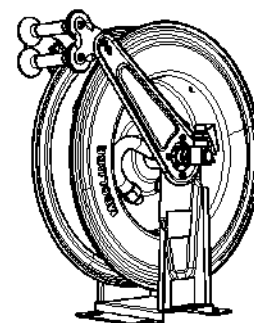

Application bench with frontal output hose

# SWIVELLING AUTOMATIC HOSE REELS IN PAINTED STEEL FOR AIR-WATER 20 bar

Equipped with:

- Blue polyurethane ether-based hoses
- Nickel-plated brass or galvanized steel connections
- Brass 90° swivelling joint
- Viton® seals

Article	L. hose	Ø hose	Max pressure	Inlet-Outlet
071-1201-300	without hose	-	-	F1/2" - M3/8" BSP
071-1201-400	without hose	-	-	F1/2" - M1/2" BSP
071-1201-215	15 m	8x12	20 bar	F1/2"G - M1/4"G gir.
071-1201-220	20 m	8x12	20 bar	F1/2"G - M1/4"G gir.
071-1201-310	10 m	10x14	20 bar	F1/2" - M3/8" BSP
071-1201-315	15 m	10x14	20 bar	F1/2" - M3/8" BSP
071-1201-410	10 m	13x19	20 bar	F1/2" - M1/2" BSP

S-400



Article	L. hose	Ø hose	Max pressure	Inlet-Outlet
071-1301-300	without hose	-	-	F1/2" - M3/8" BSP
071-1301-400	without hose	-	-	F1/2" - M1/2" BSP
071-1301-320	20 m	10x14	20 bar	F1/2" - M3/8" BSP
071-1301-415	15 m	13x19	20 bar	F1/2" - M1/2" BSP
071-1301-418	18 m	13x19	20 bar	F1/2" - M1/2" BSP

S-460



Article	L. hose	Ø hose	Max pressure	Inlet-Outlet
071-1401-400	without hose	-	-	F1/2" - M1/2" BSP
071-1401-420	20 m	13x19	20 bar	F1/2" - M1/2" BSP
071-1401-425	25 m	13x19	20 bar	F1/2" - M1/2" BSP

S-550



## OVERALL DIMENSIONS SWIVELLING VERSION

Mod.	A	B	C	D	E	F	G	H	Kg	m³	W³
S-400	150	120	168	196	95	460	400	550	15,51<17,51	0,084	1
S-460	150	120	168	196	95	490	460	575	17,50<24,00	0,094	1
S-550	200	150	225	270	120	572	550	680	23,00<29,00	0,130	1

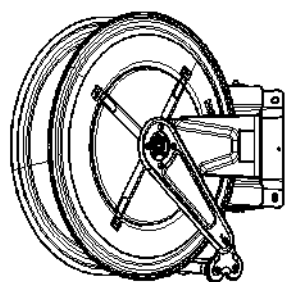
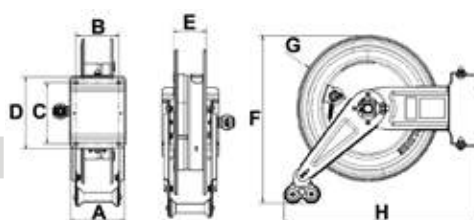

Wall application with internal output hose

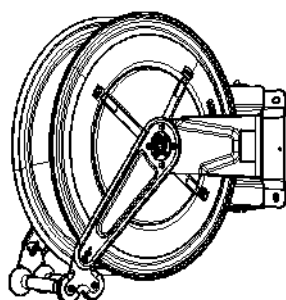

Wall application with external output hose

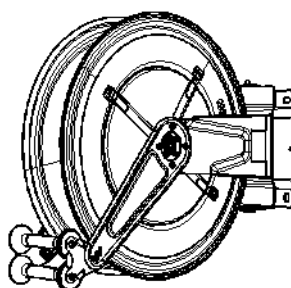

Wall and ceiling application with frontal outside hose

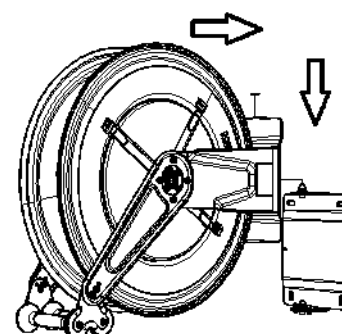

The insertion of the hose reel in the wall bracket is with quick disconnect coupling

# FIXED AUTOMATIC HOSE REELS IN PAINTED STEEL FOR AIR-WATER FROM 20 TO 28 bar

Equipped with:

- Black synthetic rubber hoses R6, Galvanized steel connections
- Brass 90° swivelling joint, Viton® seals

F-400	Article	L. hose	Ø hose	Max pressure	Inlet-Outlet
	070-1201-300	without hose	-	-	F1/2"-M3/8"BSP
	070-1201-400	without hose	-	-	F1/2"-M1/2"BSP
	070-1202-212	12 m	5/16"	28 bar	F1/2"-M1/4"BSP
	070-1202-218	18 m	5/16"	28 bar	F1/2"-M1/4"BSP
	070-1202-310	10 m	3/8"	28 bar	F1/2"-M3/8"BSP
	070-1202-315	15 m	3/8"	28 bar	F1/2"-M3/8"BSP
	070-1202-410	10 m	1/2"	28 bar	F1/2"-M1/2"BSP
F-460	Article	L. hose	Ø hose	Max pressure	Inlet-Outlet
	070-1301-300	without hose	-	-	F1/2"-M3/8"BSP
	070-1301-400	without hose	-	-	F1/2"-M1/2"BSP
	070-1302-318	18 m	3/8"	28 bar	F1/2"-M3/8"BSP
	070-1302-320	20 m	3/8"	28 bar	F1/2"-M3/8"BSP
	070-1302-415	15 m	1/2"	28 bar	F1/2"-M1/2"BSP
	070-1302-418	18 m	1/2"	28 bar	F1/2"-M1/2"BSP
F-550	Article	L. hose	Ø hose	Max pressure	Inlet-Outlet
	070-1401-400	without hose	-	-	F1/2"-M1/2"BSP
	070-1402-500	without hose	-	-	F1"-M3/4"BSP
	070-1402-420	20 m	1/2"	28 bar	F1/2"-M1/2"BSP
	070-1402-425	25 m	1/2"	28 bar	F1/2"-M1/2"BSP
	070-1402-515	15 m	3/4"	21 bar	F1"-M3/4"BSP
F-555	Article	L. hose	Ø hose	Max pressure	Inlet-Outlet
	070-1502-400	without hose	-	-	F1/2"-M1/2"BSP
	070-1502-500	without hose	-	-	F1"-M3/4"BSP
	070-1502-600	without hose	-	-	F1"-M1"BSP
	070-1502-430	30 m	1/2"	28 bar	F1/2"-M1/2"BSP
	070-1502-520	20 m	3/4"	21 bar	F1"G-M3/4"BSP
	070-1502-615	15 m	1"	20 bar	F1"-M1"BSP
F-560	Article	L. hose	Ø hose	Max pressure	Inlet-Outlet
	070-1602-400	without hose	-	-	F1/2"-M1/2"BSP
	070-1602-500	without hose	-	-	F1"-M3/4"BSP
	070-1602-600	without hose	-	-	F1"-M1"BSP
	070-1602-440	40 m	1/2"	28 bar	F1/2"-M1/2"BSP
	070-1602-530	30 m	3/4"	21 bar	F1"-M3/4"BSP
	070-1602-540	40 m	3/4"	21 bar	F1"-M3/4"BSP
	070-1602-620	20 m	1"	20 bar	F1"-M1"BSP
	070-1602-630	30 m	1"	20 bar	F1"-M1"BSP

## OVERALL DIMENSIONS FIXED VERSION

Mod.	A	B	C	D	E	F	G	H	Kg	m <sup>3</sup>	W
F-400	158	120	168	192	95	460	400	435	12,50<19,50	0,084	1
F-460	158	120	168	192	95	490	460	490	16,50<23,00	0,094	1
F-550	200	150	225	270	120	590	550	600	22,00<45,00	0,130	1
F-555	250	200	225	270	170	590	550	600	26,00<53,00	0,150	1
F-560	440	390	225	270	360	590	550	600	33,00<83,00	0,240	1

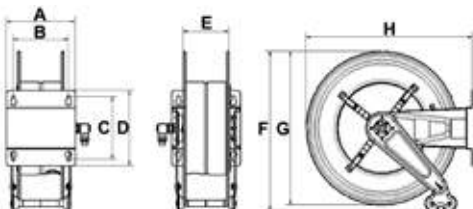



# SWIVELLING AUTOMATIC HOSE REELS IN PAINTED STEEL FOR AIR-WATER FROM 20 TO 28 bar

Equipped with:

- Black synthetic rubber hoses R6, Galvanized steel connections
- Brass 90° swivelling joint, Viton® seals

Article	L. hose	Ø hose	Max pressure	Inlet-Outlet	S-400
071-1201-300	without hose	-	-	F1/2" - M3/8" BSP	
071-1201-400	without hose	-	-	F1/2" - M1/2" BSP	
071-1202-212	12 m	5/16"	28 bar	F1/2" - M1/4" BSP	
071-1202-218	18 m	5/16"	28 bar	F1/2" - M1/4" BSP	
071-1202-310	10 m	3/8"	28 bar	F1/2" - M3/8" BSP	
071-1202-315	15 m	3/8"	28 bar	F1/2" - M3/8" BSP	
071-1202-410	10 m	1/2"	28 bar	F1/2" - M1/2" BSP	

Article	L. hose	Ø hose	Max pressure	Inlet-Outlet	S-460
071-1301-300	without hose	-	-	F1/2" - M3/8" BSP	
071-1301-400	without hose	-	-	F1/2" - M1/2" BSP	
071-1302-318	18 m	3/8"	28 bar	F1/2" - M3/8" BSP	
071-1302-320	20 m	3/8"	28 bar	F1/2" - M3/8" BSP	
071-1302-415	15 m	1/2"	28 bar	F1/2" - M1/2" BSP	
071-1302-418	18 m	1/2"	28 bar	F1/2" - M1/2" BSP	

Article	L. hose	Ø hose	Max pressure	Inlet-Outlet	S-550
071-1401-400	without hose	-	-	F1/2" - M1/2" BSP	
071-1402-500	without hose	-	-	F1" - M3/4" BSP	
071-1402-420	20 m	1/2"	28 bar	F1/2" - M1/2" BSP	
071-1402-425	25 m	1/2"	28 bar	F1/2" - M1/2" BSP	
071-1402-515	15 m	3/4"	21 bar	F1" - M3/4" BSP	

Article	L. hose	Ø hose	Max pressure	Inlet-Outlet	S-555
071-1502-400	without hose	-	-	F1/2" - M1/2" BSP	
071-1502-500	without hose	-	-	F1" - M3/4" BSP	
071-1502-600	without hose	-	-	F1" - M1" BSP	
071-1502-430	30 m	1/2"	28 bar	F1/2" - M1/2" BSP	
071-1502-520	20 m	3/4"	21 bar	F1" - M3/4" BSP	
071-1502-615	15 m	1"	20 bar	F1" - M1" BSP	

## OVERALL DIMENSIONS SWIVELLING VERSION

Mod.	A	B	C	D	E	F	G	H			
S-400	150	120	168	196	95	460	400	550	13,50<20,50	0,084	1
S-460	150	120	168	196	95	490	460	575	17,50<24,00	0,094	1
S-550	200	150	225	270	120	572	550	680	23,00<45,00	0,130	1
S-555	250	200	225	270	170	572	550	680	27,00<54,00	0,150	1

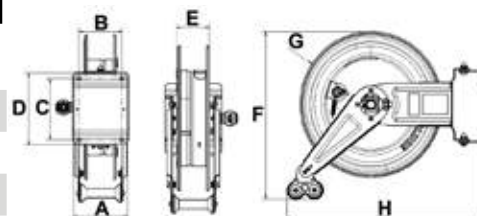

# FIXED AUTOMATIC HOSE REELS IN PAINTED STEEL FOR WATER 150 °C 200 bar

Equipped with:

- Blue no trace synthetic rubber hoses 1SC
- Galvanized steel connections
- AISI 304 stainless steel 90° swivelling joint
- Viton® seals

F-400	Article	L. hose	Ø hose	Max pressure	Inlet-Outlet
	070-1205-300	without hose	-	-	F1/2"-M3/8"BSP
	070-1205-400	without hose	-	-	F1/2"-M1/2"BSP
	070-1204-210	10 m	5/16"	200 bar	F1/2"-F3/8"BSP
	070-1204-215	15 m	5/16"	200 bar	F1/2"-F3/8"BSP
	070-1204-310	10 m	3/8"	200 bar	F1/2"-F3/8"BSP
	070-1204-410	10 m	1/2"	200 bar	F1/2"-F1/2"BSP



F-460	Article	L. hose	Ø hose	Max pressure	Inlet-Outlet
	070-1305-300	without hose	-	-	F1/2"-M3/8"BSP
	070-1305-400	without hose	-	-	F1/2"-M1/2"BSP
	070-1304-220	20 m	5/16"	200 bar	F1/2"-F3/8"BSP
	070-1304-315	15 m	3/8"	200 bar	F1/2"-F3/8"BSP
	070-1304-318	18 m	3/8"	200 bar	F1/2"-F3/8"BSP
	070-1304-415	15 m	1/2"	200 bar	F1/2"-F1/2"BSP

F-550	Article	L. hose	Ø hose	Max pressure	Inlet-Outlet
	070-1405-300	without hose	-	-	F1/2"-M3/8"BSP
	070-1405-400	without hose	-	-	F1/2"-M1/2"BSP
	070-1404-320	20 m	3/8"	200 bar	F1/2"-F3/8"BSP
	070-1404-325	25 m	3/8"	200 bar	F1/2"-F3/8"BSP
	070-1404-420	20 m	1/2"	200 bar	F1/2"-F1/2"BSP
	070-1404-425	25 m	1/2"	200 bar	F1/2"-F1/2"BSP

F-555	Article	L. hose	Ø hose	Max pressure	Inlet-Outlet
	070-1505-300	without hose	-	-	F1/2"-M3/8"BSP
	070-1505-400	without hose	-	-	F1/2"-M1/2"BSP
	070-1504-330	30 m	3/8"	200 bar	F1/2"-F3/8"BSP
	070-1504-430	30 m	1/2"	200 bar	F1/2"-F1/2"BSP

F-560	Article	L. hose	Ø hose	Max pressure	Inlet-Outlet
	070-1605-400	without hose	-	-	F1/2"-M1/2"BSP
	070-1604-340	40 m	3/8"	200 bar	F1/2"-F3/8"BSP
	070-1604-350	50 m	3/8"	200 bar	F1/2"-F3/8"BSP
	070-1604-440	40 m	1/2"	200 bar	F1/2"-F1/2"BSP

## OVERALL DIMENSIONS FIXED VERSION

Mod.	A	B	C	D	E	F	G	H			
F-400	158	120	168	192	95	460	400	435	12,50<19,50	0,084	1
F-460	158	120	168	192	95	490	460	490	16,50<23,00	0,094	1
F-550	200	150	225	270	120	590	550	600	22,00<45,00	0,130	1
F-555	250	200	225	270	170	590	550	600	26,00<53,00	0,150	1
F-560	440	390	225	270	360	590	550	600	33,00<83,00	0,240	1

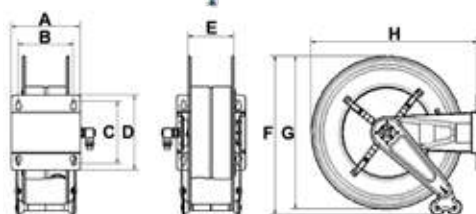

# SWIVELLING AUTOMATIC HOSE REELS IN PAINTED STEEL FOR WATER 150 °C 200 bar

Equipped with:

- Blue no trace synthetic rubber hoses 1SC
- Galvanized steel connections
- AISI 304 stainless steel 90° swivelling joint
- Viton® seals

Article	L. hose	Ø hose	Max pressure	Inlet-Outlet
071-1205-300	without hose	-	-	F1/2" - M3/8" BSP
071-1205-400	without hose	-	-	F1/2" - M1/2" BSP
071-1204-210	10 m	5/16"	200 bar	F1/2" - F3/8" BSP
071-1204-215	15 m	5/16"	200 bar	F1/2" - F3/8" BSP
071-1204-310	10 m	3/8"	200 bar	F1/2" - F3/8" BSP
071-1204-410	10 m	1/2"	200 bar	F1/2" - F1/2" BSP

S-400



Article	L. hose	Ø hose	Max pressure	Inlet-Outlet
071-1305-300	without hose	-	-	F1/2" - M3/8" BSP
071-1305-400	without hose	-	-	F1/2" - M1/2" BSP
071-1304-220	20 m	5/16"	200 bar	F1/2" - F3/8" BSP
071-1304-315	15 m	3/8"	200 bar	F1/2" - F3/8" BSP
071-1304-318	18 m	3/8"	200 bar	F1/2" - F3/8" BSP
071-1304-415	15 m	1/2"	200 bar	F1/2" - F1/2" BSP

S-460



Article	L. hose	Ø hose	Max pressure	Inlet-Outlet
071-1405-300	without hose	-	-	F1/2" - M3/8" BSP
071-1405-400	without hose	-	-	F1/2" - M1/2" BSP
071-1404-320	20 m	3/8"	200 bar	F1/2" - F3/8" BSP
071-1404-325	25 m	3/8"	200 bar	F1/2" - F3/8" BSP
071-1404-420	20 m	1/2"	200 bar	F1/2" - F1/2" BSP
071-1404-425	25 m	1/2"	200 bar	F1/2" - F1/2" BSP

S-550





Article	L. hose	Ø hose	Max pressure	Inlet-Outlet
071-1505-300	without hose	-	-	F1/2" - M3/8" BSP
071-1505-400	without hose	-	-	F1/2" - M1/2" BSP
071-1504-330	30 m	3/8"	200 bar	F1/2" - F3/8" BSP
071-1504-430	30 m	1/2"	200 bar	F1/2" - F1/2" BSP

S-555



## OVERALL DIMENSIONS SWIVELLING VERSION

Mod.	A	B	C	D	E	F	G	H				
S-400	150	120	168	196	95	460	400	550	13,50	<20,50	0,084	1
S-460	150	120	168	196	95	490	460	575	17,50	<24,00	0,094	1
S-550	200	150	225	270	120	572	550	680	23,00	<45,00	0,130	1
S-555	250	200	225	270	170	572	550	680	27,00	<54,00	0,150	1

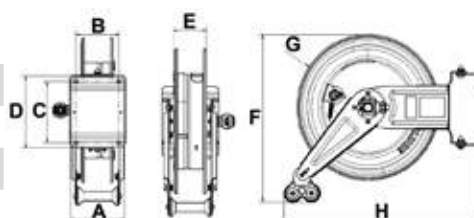

# FIXED AUTOMATIC HOSE REELS IN PAINTED STEEL FOR WATER 150 °C 400 bar

Equipped with:

- Blue no trace synthetic rubber hoses 2SC
- Galvanized steel connections
- AISI 304 stainless steel 90° swivelling joint
- Viton® seals



F-400	Article	L. hose	Ø hose	Max pressure	Inlet-Outlet
	070-1205-300	without hose	-	-	F1/2"-M3/8"BSP
	070-1205-400	without hose	-	-	F1/2"-M1/2"BSP
	070-1205-210	10 m	5/16"	400 bar	F1/2"-F3/8"BSP
	070-1205-215	15 m	5/16"	400 bar	F1/2"-F3/8"BSP
	070-1205-310	10 m	3/8"	400 bar	F1/2"-F3/8"BSP
	070-1205-410	10 m	1/2"	400 bar	F1/2"-F1/2"BSP



F-460	Article	L. hose	Ø hose	Max pressure	Inlet-Outlet
	070-1305-300	without hose	-	-	F1/2"-M3/8"BSP
	070-1305-400	without hose	-	-	F1/2"-M1/2"BSP
	070-1305-220	20 m	5/16"	400 bar	F1/2"-F3/8"BSP
	070-1305-315	15 m	3/8"	400 bar	F1/2"-F3/8"BSP
	070-1305-318	18 m	3/8"	400 bar	F1/2"-F3/8"BSP
	070-1305-415	15 m	1/2"	400 bar	F1/2"-F1/2"BSP



F-550	Article	L. hose	Ø hose	Max pressure	Inlet-Outlet
	070-1405-300	without hose	-	-	F1/2"-M3/8"BSP
	070-1405-400	without hose	-	-	F1/2"-M1/2"BSP
	070-1405-320	20 m	3/8"	400 bar	F1/2"-F3/8"BSP
	070-1405-325	25 m	3/8"	400 bar	F1/2"-F3/8"BSP
	070-1405-420	20 m	1/2"	400 bar	F1/2"-F1/2"BSP
	070-1405-425	25 m	1/2"	400 bar	F1/2"-F1/2"BSP





F-555	Article	L. hose	Ø hose	Max pressure	Inlet-Outlet
	070-1505-300	without hose	-	-	F1/2"-M3/8"BSP
	070-1505-400	without hose	-	-	F1/2"-M1/2"BSP
	070-1505-330	30 m	3/8"	400 bar	F1/2"-F3/8"BSP
	070-1505-430	30 m	1/2"	400 bar	F1/2"-F1/2"BSP



F-560	Article	L. hose	Ø hose	Max pressure	Inlet-Outlet
	070-1605-400	without hose	-	-	F1/2"-M1/2"BSP
	070-1605-340	40 m	3/8"	400 bar	F1/2"-F3/8"BSP
	070-1605-350	50 m	3/8"	400 bar	F1/2"-F3/8"BSP
	070-1605-440	40 m	1/2"	400 bar	F1/2"-F1/2"BSP

## OVERALL DIMENSIONS FIXED VERSION

Mod.	A	B	C	D	E	F	G	H			
F-400	158	120	168	192	95	460	400	435	12,50<19,50	0,084	1
F-460	158	120	168	192	95	490	460	490	16,50<23,00	0,094	1
F-550	200	150	225	270	120	590	550	600	22,00<45,00	0,130	1
F-555	250	200	225	270	170	590	550	600	26,00<53,00	0,150	1
F-560	440	390	225	270	360	590	550	600	33,00<83,00	0,240	1

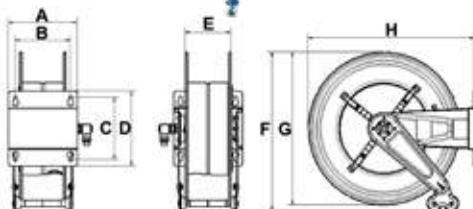

# SWIVELLING AUTOMATIC HOSE REELS IN PAINTED STEEL FOR WATER 150 °C 400 bar

Equipped with:

- Blue no trace synthetic rubber hoses 2SC
- Galvanized steel connections
- AISI 304 stainless steel 90° swivelling joint
- Viton® seals

Article	L. hose	Ø hose	Max pressure	Inlet-Outlet
071-1205-300	without hose	-	-	F1/2" - M3/8" BSP
071-1205-400	without hose	-	-	F1/2" - M1/2" BSP
071-1205-210	10 m	5/16"	400 bar	F1/2" - F3/8" BSP
071-1205-215	15 m	5/16"	400 bar	F1/2" - F3/8" BSP
071-1205-310	10 m	3/8"	400 bar	F1/2" - F3/8" BSP
071-1205-410	10 m	1/2"	400 bar	F1/2" - F1/2" BSP

S-400



Article	L. hose	Ø hose	Max pressure	Inlet-Outlet
071-1305-300	without hose	-	-	F1/2" - M3/8" BSP
071-1305-400	without hose	-	-	F1/2" - M1/2" BSP
071-1305-220	20 m	5/16"	400 bar	F1/2" - F3/8" BSP
071-1305-315	15 m	3/8"	400 bar	F1/2" - F3/8" BSP
071-1305-318	18 m	3/8"	400 bar	F1/2" - F3/8" BSP
071-1305-415	15 m	1/2"	400 bar	F1/2" - F1/2" BSP

S-460



Article	L. hose	Ø hose	Max pressure	Inlet-Outlet
071-1405-300	without hose	-	-	F1/2" - M3/8" BSP
071-1405-400	without hose	-	-	F1/2" - M1/2" BSP
071-1405-320	20 m	3/8"	400 bar	F1/2" - F3/8" BSP
071-1405-325	25 m	3/8"	400 bar	F1/2" - F3/8" BSP
071-1405-420	20 m	1/2"	400 bar	F1/2" - F1/2" BSP
071-1405-425	25 m	1/2"	400 bar	F1/2" - F1/2" BSP

S-550





Article	L. hose	Ø hose	Max pressure	Inlet-Outlet
071-1505-300	without hose	-	-	F1/2" - M3/8" BSP
071-1505-400	without hose	-	-	F1/2" - M1/2" BSP
071-1505-330	30 m	3/8"	400 bar	F1/2" - F3/8" BSP
071-1505-430	30 m	1/2"	400 bar	F1/2" - F1/2" BSP

S-555



## OVERALL DIMENSIONS SWIVELLING VERSION

Mod.	A	B	C	D	E	F	G	H	 Kg	 m <sup>3</sup>	
S-400	150	120	168	196	95	460	400	550	13,50<20,50	0,084	1
S-460	150	120	168	196	95	490	460	575	17,50<24,00	0,094	1
S-550	200	150	225	270	120	572	550	680	23,00<45,00	0,130	1
S-555	250	200	225	270	170	572	550	680	27,00<54,00	0,150	1

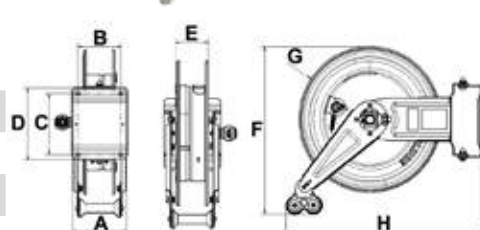

# FIXED AUTOMATIC HOSE REELS IN PAINTED STEEL FOR OIL, ANTIFREEZE AND SIMILAR FLUIDS FROM 88 TO 160 bar

Equipped with:

- Black synthetic rubber hoses 1SC
- Galvanized steel connections
- Galvanized steel 90° swivelling joint
- NBR seals



F-400	Article	L. hose	Ø hose	Max pressure	Inlet-Outlet
	070-1206-400	without hose	-	-	F1/2"-M1/2"BSP
	070-1206-310	10 m	3/8"	180 bar	F1/2"-M1/2"BSP
	070-1206-410	10 m	1/2"	160 bar	F1/2"-M1/2"BSP

F-460	Article	L. hose	Ø hose	Max pressure	Inlet-Outlet
	070-1306-400	without hose	-	-	F1/2"-M1/2"BSP
	070-1306-315	15 m	3/8"	180 bar	F1/2"-M1/2"BSP
	070-1306-415	15 m	1/2"	160 bar	F1/2"-M1/2"BSP
	070-1306-418	18 m	1/2"	160 bar	F1/2"-M1/2"BSP

F-550	Article	L. hose	Ø hose	Max pressure	Inlet-Outlet
	070-1406-400	without hose	-	-	F1/2"-M1/2"BSP
	070-1406-500	without hose	-	-	F1"-M3/4"BSP
	070-1406-420	20 m	1/2"	160 bar	F1/2"-M1/2"BSP
	070-1406-425	25 m	1/2"	160 bar	F1/2"-M1/2"BSP
	070-1406-515	15 m	3/4"	105 bar	F1"-M3/4"BSP

F-555	Article	L. hose	Ø hose	Max pressure	Inlet-Outlet
	070-1506-400	without hose	-	-	F1/2"-M1/2"BSP
	070-1506-500	without hose	-	-	F1"-M3/4"BSP
	070-1506-600	without hose	-	-	F1"-M1"BSP
	070-1506-430	30 m	1/2"	160 bar	F1/2"-M1/2"BSP
	070-1506-520	20 m	3/4"	105 bar	F1"-M3/4"BSP
	070-1506-615	15 m	1"	88 bar	F1"-M1"BSP

F-560	Article	L. hose	Ø hose	Max pressure	Inlet-Outlet
	070-1606-400	without hose	-	-	F1/2"-M1/2"BSP
	070-1606-500	without hose	-	-	F1"-M3/4"BSP
	070-1606-600	without hose	-	-	F1"-M3/4"BSP
	070-1606-440	40 m	1/2"	160 bar	F1"G-M3/4"BSP
	070-1606-525	25 m	3/4"	105 bar	F1"-M3/4"BSP
	070-1606-530	30 m	3/4"	105 bar	F1"-M3/4"BSP
	070-1606-620	20 m	1"	88 bar	F1"-M1"BSP
	070-1606-630	30 m	1"	88 bar	F1"-M1"BSP

## OVERALL DIMENSIONS FIXED VERSION

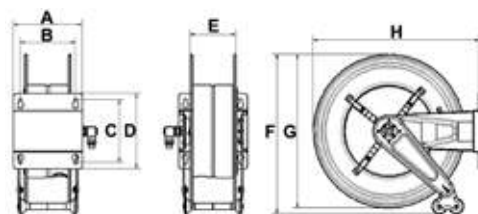

Mod.	A	B	C	D	E	F	G	H			
F-400	158	120	168	192	95	460	400	435	12,50<19,50	0,084	1
F-460	158	120	168	192	95	490	460	490	16,50<23,00	0,094	1
F-550	200	150	225	270	120	590	550	600	22,00<45,00	0,130	1
F-555	250	200	225	270	170	590	550	600	26,00<53,00	0,150	1
F-560	440	390	225	270	360	590	550	600	33,00<83,00	0,240	1

# SWIVELLING AUTOMATIC HOSE REELS IN PAINTED STEEL FOR OIL, ANTIFREEZE AND SIMILAR FLUIDS FROM 88 TO 160 bar

Equipped with:

- Black synthetic rubber hoses 1SC
- Galvanized steel connections
- Galvanized steel 90° swivelling joint
- NBR seals

Article	L. hose	Ø hose	Max pressure	Inlet-Outlet	S-400
071-1206-400	without hose	-	-	F1/2"-M1/2"BSP	
071-1206-310	10 m	3/8"	180 bar	F1/2"-M1/2"BSP	
071-1206-410	10 m	1/2"	160 bar	F1/2"-M1/2"BSP	



Article	L. hose	Ø hose	Max pressure	Inlet-Outlet	S-460
071-1306-400	without hose	-	-	F1/2"-M1/2"BSP	
071-1306-315	15 m	3/8"	180 bar	F1/2"-M1/2"BSP	
071-1306-415	15 m	1/2"	160 bar	F1/2"-M1/2"BSP	
071-1306-418	18 m	1/2"	160 bar	F1/2"-M1/2"BSP	





Article	L. hose	Ø hose	Max pressure	Inlet-Outlet	S-550
071-1406-400	without hose	-	-	F1/2"-M1/2"BSP	
071-1406-500	without hose	-	-	F1"-M3/4"BSP	
071-1406-420	20 m	1/2"	160 bar	F1/2"-M1/2"BSP	
071-1406-425	25 m	1/2"	160 bar	F1/2"-M1/2"BSP	
071-1406-515	15 m	3/4"	105 bar	F1"-M3/4"BSP	



Article	L. hose	Ø hose	Max pressure	Inlet-Outlet	S-555
071-1506-400	without hose	-	-	F1/2"-M1/2"BSP	
071-1506-500	without hose	-	-	F1"-M3/4"BSP	
071-1506-600	without hose	-	-	F1"-M1"BSP	
071-1506-430	30 m	1/2"	160 bar	F1/2"-M1/2"BSP	
071-1506-520	20 m	3/4"	105 bar	F1"-M3/4"BSP	
071-1506-615	15 m	1"	88 bar	F1"-M1"BSP	



## OVERALL DIMENSIONS SWIVELLING VERSION

Mod.	A	B	C	D	E	F	G	H			
S-400	150	120	168	196	95	460	400	550	13,50<20,50	0,084	1
S-460	150	120	168	196	95	490	460	575	17,50<24,00	0,094	1
S-550	200	150	225	270	120	572	550	680	23,00<45,00	0,130	1
S-555	250	200	225	270	170	572	550	680	27,00<54,00	0,150	1

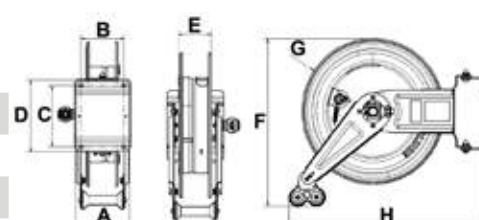

# FIXED AUTOMATIC HOSE REELS IN PAINTED STEEL FOR GREASE FROM 275 TO 400 bar

Equipped with:

- Black synthetic rubber hoses 2SC
- Galvanized steel connections
- Galvanized steel 90° swivelling joint
- Polyurethane seals



F-400	Article	L. hose	Ø hose	Max pressure	Inlet-Outlet
	070-1207-200	without hose	-	-	M1/4" - M1/4" BSP
	070-1207-300	without hose	-	-	M3/8" - M3/8" BSP
	070-1207-400	without hose	-	-	M1/2" - M1/2" BSP
	070-1207-110	10 m	1/4"	400 bar	M1/4" - M1/4" BSP
	070-1207-115	15 m	1/4"	400 bar	M1/4" - M1/4" BSP
	070-1207-310	10 m	3/8"	330 bar	M3/8" - M3/8" BSP
	070-1207-410	10 m	1/2"	275 bar	M1/2" - M1/2" BSP



F-460	Article	L. hose	Ø hose	Max pressure	Inlet-Outlet
	070-1307-200	without hose	-	-	M1/4" - M1/4" BSP
	070-1307-300	without hose	-	-	M3/8" - M3/8" BSP
	070-1307-400	without hose	-	-	M1/2" - M1/2" BSP
	070-1307-118	18 m	1/4"	400 bar	M1/4" - M1/4" BSP
	070-1307-315	15 m	3/8"	330 bar	M3/8" - M3/8" BSP
	070-1307-415	15 m	1/2"	275 bar	M1/2" - M1/2" BSP





F-550	Article	L. hose	Ø hose	Max pressure	Inlet-Outlet
	070-1407-300	without hose	-	-	M3/8" - M3/8" BSP
	070-1407-400	without hose	-	-	M1/2" - M1/2" BSP
	070-1407-320	20 m	3/8"	330 bar	M3/8" - M3/8" BSP
	070-1407-325	25 m	3/8"	330 bar	M3/8" - M3/8" BSP
	070-1407-420	20 m	1/2"	275 bar	M1/2" - M1/2" BSP
	070-1407-425	25 m	1/2"	275 bar	M1/2" - M1/2" BSP

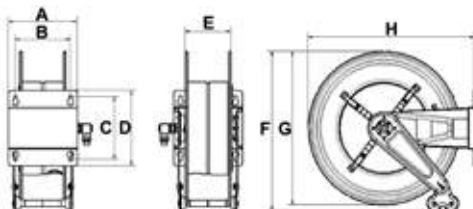

F-555	Article	L. hose	Ø hose	Max pressure	Inlet-Outlet
	070-1507-300	without hose	-	-	M3/8" - M3/8" BSP
	070-1507-400	without hose	-	-	M1/2" - M1/2" BSP
	070-1507-330	30 m	3/8"	330 bar	M3/8" - M3/8" BSP
	070-1507-430	30 m	1/2"	275 bar	M1/2" - M1/2" BSP



## OVERALL DIMENSIONS FIXED VERSION

Mod.	A	B	C	D	E	F	G	H			
F-400	158	120	168	192	95	460	400	435	12,50<19,50	0,084	1
F-460	158	120	168	192	95	490	460	490	16,50<23,00	0,094	1
F-550	200	150	225	270	120	590	550	600	22,00<45,00	0,130	1
F-555	250	200	225	270	170	590	550	600	26,00<53,00	0,150	1

# SWIVELLING AUTOMATIC HOSE REELS IN PAINTED STEEL FOR GREASE FROM 275 TO 400 bar

Equipped with:

- Black synthetic rubber hoses 2SC
- Galvanized steel connections
- Galvanized steel 90° swivelling joint
- Polyurethane seals



Article	L. hose	Ø hose	Max pressure	Inlet-Outlet	S-400
071-1207-200	without hose	-	-	M1/4" - M1/4" BSP	
071-1207-300	without hose	-	-	M3/8" - M3/8" BSP	
071-1207-400	without hose	-	-	M1/2" - M1/2" BSP	
071-1207-110	10 m	1/4"	400 bar	M1/4" - M1/4" BSP	
071-1207-115	15 m	1/4"	400 bar	M1/4" - M1/4" BSP	
071-1207-310	10 m	3/8"	330 bar	M3/8" - M3/8" BSP	
071-1207-410	10 m	1/2"	275 bar	M1/2" - M1/2" BSP	

Article	L. hose	Ø hose	Max pressure	Inlet-Outlet	S-460
071-1307-200	without hose	-	-	M1/4" - M1/4" BSP	
071-1307-300	without hose	-	-	M3/8" - M3/8" BSP	
071-1307-400	without hose	-	-	M1/2" - M1/2" BSP	
071-1307-118	18 m	1/4"	400 bar	M1/4" - M1/4" BSP	
071-1307-315	15 m	3/8"	330 bar	M3/8" - M3/8" BSP	
071-1307-415	15 m	1/2"	275 bar	M1/2" - M1/2" BSP	

Article	L. hose	Ø hose	Max pressure	Inlet-Outlet	S-550
071-1407-300	without hose	-	-	M3/8" - M3/8" BSP	
071-1407-400	without hose	-	-	M1/2" - M1/2" BSP	
071-1407-320	20 m	3/8"	330 bar	M3/8" - M3/8" BSP	
071-1407-325	25 m	3/8"	330 bar	M3/8" - M3/8" BSP	
071-1407-420	20 m	1/2"	275 bar	M1/2" - M1/2" BSP	
071-1407-425	25 m	1/2"	275 bar	M1/2" - M1/2" BSP	

Article	L. hose	Ø hose	Max pressure	Inlet-Outlet	S-555
071-1507-300	without hose	-	-	M3/8" - M3/8" BSP	
071-1507-400	without hose	-	-	M1/2" - M1/2" BSP	
071-1507-330	30 m	3/8"	330 bar	M3/8" - M3/8" BSP	
071-1507-430	30 m	1/2"	275 bar	M1/2" - M1/2" BSP	

## OVERALL DIMENSIONS SWIVELLING VERSION

Mod.	A	B	C	D	E	F	G	H			
S-400	150	120	168	196	95	460	400	550	13,50<20,50	0,084	1
S-460	150	120	168	196	95	490	460	575	17,50<24,00	0,094	1
S-550	200	150	225	270	120	572	550	680	23,00<45,00	0,130	1
S-555	250	200	225	270	170	572	550	680	27,00<54,00	0,150	1

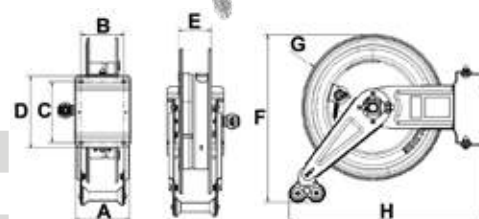

# FIXED AUTOMATIC HOSE REELS IN PAINTED STEEL FOR ANTIFREEZE - WINDSCREEN - AdBlue® 20 bar

Equipped with:

- Black antistatic synthetic rubber EPDM hoses
- AISI 316 stainless steel connections
- Stainless steel 90° swivelling joint
- Viton® seals
- Stainless steel reel shaft



F-400	Article	L. hose	Ø hose	Max pressure	Inlet-Outlet
	070-1209-400	without hose	-	-	F1/2"-M1/2"BSP
	070-1209-410	10 m	1/2"	20 bar	F1/2"-M1/2" BSP



F-460	Article	L. hose	Ø hose	Max pressure	Inlet-Outlet
	070-1309-400	without hose	-	-	F1/2"-M1/2" BSP
	070-1309-415	15 m	1/2"	20 bar	F1/2"-M1/2" BSP



F-550	Article	L. hose	Ø hose	Max pressure	Inlet-Outlet
	070-1409-400	without hose	-	-	F1/2"-M1/2" BSP
	070-1409-500	without hose	-	-	F1"-M3/4" BSP
	070-1409-420	20 m	1/2"	20 bar	F1/2"-M1/2" BSP
	070-1409-425	25 m	1/2"	20 bar	F1/2"-M 1/2" BSP
	070-1409-510	10 m	3/4"	20 bar	F1"-M3/4" BSP
	070-1409-515	15 m	3/4"	20 bar	F1"-M3/4" BSP



F-555	Article	L. hose	Ø hose	Max pressure	Inlet-Outlet
	070-1509-500	without hose	-	-	F1"-M3/4" BSP
	070-1509-520	20 m	3/4"	20 bar	F1"-M3/4" BSP

## OVERALL DIMENSIONS FIXED VERSION

Mod.	A	B	C	D	E	F	G	H			
F-400	158	120	168	192	95	460	400	435	12,50<19,50	0,084	1
F-460	158	120	168	192	95	490	460	490	16,50<23,00	0,094	1
F-550	200	150	225	270	120	590	550	600	22,00<45,00	0,130	1
F-555	250	200	225	270	170	590	550	600	26,00<53,00	0,150	1

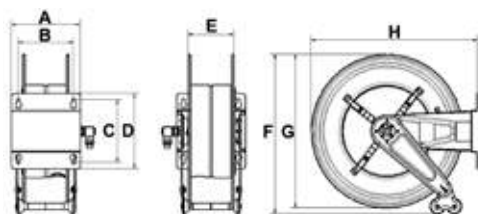

# SWIVELLING AUTOMATIC HOSE REELS IN PAINTED STEEL FOR ANTIFREEZE - WINDSCREEN - AdBlue® 20 bar

Equipped with:

- Black antistatic synthetic rubber EPDM hoses
- AISI 316 stainless steel connections
- Stainless steel 90° swivelling joint
- Viton® seals
- Stainless steel reel shaft

Article	L. hose	Ø hose	Max pressure	Inlet-Outlet	S-400
071-1209-400	without hose	-	-	F1/2"-M1/2" BSP	
071-1209-410	10 m	1/2"	20 bar	F1/2"-M1/2" BSP	



Article	L. hose	Ø hose	Max pressure	Inlet-Outlet	S-460
071-1309-400	without hose	-	-	F1/2"-M1/2" BSP	
071-1309-415	15 m	1/2"	20 bar	F1/2"-M1/2" BSP	



Article	L. hose	Ø hose	Max pressure	Inlet-Outlet	S-550
071-1409-400	without hose	-	-	F1/2"-M1/2" BSP	
071-1409-500	without hose	-	-	F1"-M3/4" BSP	
071-1409-420	20 m	1/2"	20 bar	F1/2"-M1/2" BSP	
071-1409-425	25 m	1/2"	20 bar	F1/2"-M 1/2" BSP	
071-1409-510	10 m	3/4"	20 bar	F1"-M3/4" BSP	
071-1409-515	15 m	3/4"	20 bar	F1"-M3/4" BSP	



Article	L. hose	Ø hose	Max pressure	Inlet-Outlet	S-555
071-1509-500	without hose	-	-	F1"-M3/4" BSP	
071-1509-520	20 m	3/4"	20 bar	F1"-M3/4" BSP	



## OVERALL DIMENSIONS SWIVELLING VERSION

Mod.	A	B	C	D	E	F	G	H	Kg	m³	№
S-400	150	120	168	196	95	460	400	550	13,50<20,50	0,084	1
S-460	150	120	168	196	95	490	460	575	17,50<24,00	0,094	1
S-550	200	150	225	270	120	572	550	680	23,00<45,00	0,130	1
S-555	250	200	225	270	170	572	550	680	27,00<54,00	0,150	1

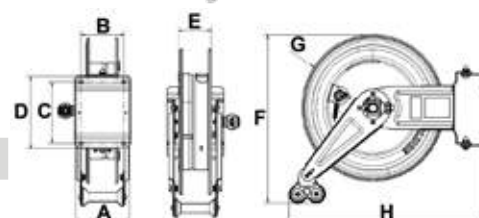

# FIXED AUTOMATIC HOSE REELS IN PAINTED STEEL FOR DIESEL 10 bar

Equipped with:

- Black antistatic rubber hoses
- Galvanized steel connections
- Galvanized steel - anodized aluminum 90° swivelling joint
- Viton® seals



F-460	Article	Capacity	L. hose	Ø hose	Inlet-Outlet
	070-1308-500	80 l/min	without hose	-	F1"-M3/4"BSP
	070-1308-508	80 l/min	8 m	3/4" - 19x27	F1"-M1" BSP



F-550	Article	Capacity	L. hose	Ø hose	Inlet-Outlet
	070-1408-600	95 l/min	without hose	-	F1"-M1" BSP
	070-1408-510	90 l/min	10 m	3/4" - 19x27	F1"-M1" BSP
	070-1408-515	85 l/min	15m	3/4" - 19x27	F1"-M1" BSP
	070-1408-610	95 l/min	10m	1" - 25x35	F1"-M1" BSP





F-555	Article	Capacity	L. hose	Ø hose	Inlet-Outlet
	070-1508-600	95 l/min	without hose	-	F1"-M1" BSP
	070-1508-520	83 l/min	20 m	3/4" - 19x27	F1"-M1" BSP
	070-1508-615	90 l/min	15 m	1" - 25x35	F1"-M1" BSP

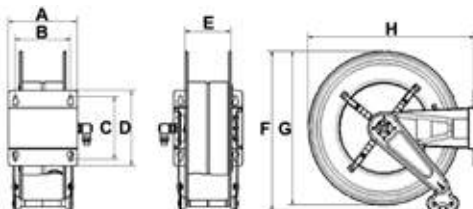

F-560	Article	Capacity	L. hose	Ø hose	Inlet-Outlet
	070-1608-600	95 l/min	without hose	-	F1"-M1" BSP
	070-1608-530	80 l/min	30 m	3/4" - 19x27	F1"-M1" BSP
	070-1608-540	75 l/min	40 m	3/4" - 19x27	F1"-M1" BSP
	070-1608-620	87 l/min	20 m	1" - 25x35	F1"-M1" BSP
	070-1608-630	85 l/min	30 m	1" - 25x35	F1"-M1" BSP



## OVERALL DIMENSIONS FIXED VERSION

Mod.	A	B	C	D	E	F	G	H			
F-460	158	120	168	192	95	490	460	490	16,50<23,00	0,094	1
F-550	200	150	225	270	120	590	550	600	22,00<45,00	0,130	1
F-555	250	200	225	270	170	590	550	600	26,00<53,00	0,150	1
F-560	440	390	225	270	360	590	550	600	33,00<83,00	0,240	1

# SWIVELLING AUTOMATIC HOSE REELS IN PAINTED STEEL FOR DIESEL 10 bar

Equipped with:

- Black antistatic rubber hoses
- Galvanized steel connections
- Galvanized steel - anodized aluminum 90° swivelling joint
- Viton® seals

Article	Capacity	L. hose	Ø hose	Inlet-Outlet
071-1308-500	80 l/min	without hose	-	F1"-M3/4" BSP
071-1308-508	80 l/min	8 m	3/4"- 19x27	F1"-M1" BSP

S-460



Article	Capacity	L. hose	Ø hose	Inlet-Outlet
071-1408-600	95 l/min	without hose	-	F1"-M1" BSP
071-1408-510	90 l/min	10 m	3/4"- 19x27	F1"-M1" BSP
071-1408-515	85 l/min	15m	3/4"- 19x27	F1"-M1" BSP
071-1408-610	95 l/min	10m	1" - 25x35	F1"-M1" BSP

S-550



Article	Capacity	L. hose	Ø hose	Inlet-Outlet
071-1508-600	95 l/min	without hose	-	F1"-M1" BSP
071-1508-520	83 l/min	20 m	3/4"- 19x27	F1"-M1" BSP
071-1508-615	90 l/min	15 m	1" - 25x35	F1"-M1" BSP

S-555



## OVERALL DIMENSIONS SWIVELLING VERSION

Mod.	A	B	C	D	E	F	G	H
S-460	150	120	168	196	95	490	460	575
S-550	200	150	225	270	120	572	550	680
S-555	250	200	225	270	170	572	550	680

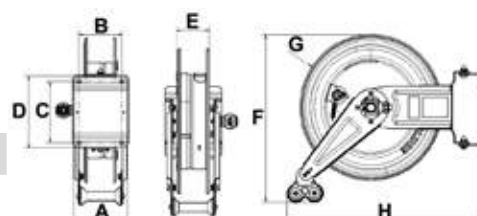

# FIXED AUTOMATIC HOSE REELS IN PAINTED STEEL FOR GASOLINE 16 bar

Equipped with:

- Black antistatic synthetic rubber hoses steel wire helix with high strength synthetic textile plies, copper wire
- Reference regulations: EN 1761 - EN 12115 ATEX (EX ZONE)
- Self-extinguishing according to: TRbf 131/2
- Galvanized steel connections
- Galvanized steel 90° swivelling joint - Viton® seals
- Compliant with ATEX directive (see ATEX regulation at page 390)

**CE** **Ex** II 2 G Ex h IIB T4 Gb X  
II 2 D Ex h IIIC T4 Db



**F-550**

Article	Capacity	L. hose	Ø hose	Inlet-Outlet
070-1418-600	95 l/min	without hose	-	F1"-M1"BSP
070-1418-510	90 l/min	10 m	3/4"- 19x27	F1"-M1" BSP
070-1418-515	85 l/min	15 m	3/4"- 19x27	F1"-M1" BSP
070-1418-610	95 l/min	10 m	1" - 25x35	F1"-M1" BSP



**F-555**

Article	Capacity	L. hose	Ø hose	Inlet-Outlet
070-1518-600	95 l/min	without hose	-	F1"-M1" BSP
070-1518-520	83 l/min	20 m	3/4"- 19x27	F1"-M1" BSP
070-1518-615	90 l/min	15 m	1" - 25x35	F1"-M1" BSP



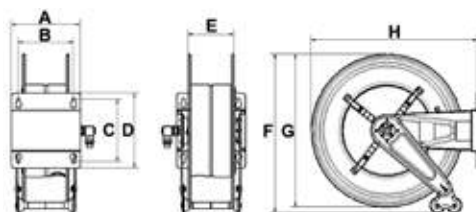

**F-560**

Article	Capacity	L. hose	Ø hose	Inlet-Outlet
070-1618-600	95 l/min	without hose	-	F1"-M1" BSP
070-1618-530	80 l/min	30 m	3/4"- 19x27	F1"-M1" BSP
070-1618-620	87 l/min	20 m	1" - 25x35	F1"-M1" BSP
070-1618-630	85 l/min	30 m	1" - 25x35	F1"-M1" BSP



## OVERALL DIMENSIONS FIXED VERSION

Mod.	A	B	C	D	E	F	G	H			
F-550	200	150	225	270	120	590	550	600	22,00<45,00	0,130	1
F-555	250	200	225	270	170	590	550	600	26,00<53,00	0,150	1
F-560	440	390	225	270	360	590	550	600	33,00<83,00	0,240	1

# SWIVELLING AUTOMATIC HOSE REELS IN PAINTED STEEL FOR GASOLINE 16 bar

Equipped with:

- Black antistatic synthetic rubber hoses steel wire helix with high strength synthetic textile plies, copper wire
- Reference regulations: EN 1761 - EN 12115 ATEX (EX ZONE)
- Self-extinguishing according to: TRbf 131/2
- Galvanized steel connections
- Galvanized steel 90° swivelling joint - Viton® seals
- Compliant with ATEX directive (see ATEX regulation at page 390)

CE Ex II 2 G Ex h IIB T4 Gb X  
II 2 D Ex h IIIC T4 Db

Article	Capacity	L. hose	Ø hose	Inlet-Outlet
071-1418-600	95 l/min	without hose	-	F1"-M1" BSP
071-1418-510	90 l/min	10 m	3/4"- 19x27	F1"-M1" BSP
071-1418-515	85 l/min	15 m	3/4"- 19x27	F1"-M1" BSP
071-1418-610	95 l/min	10 m	1" - 25x35	F1"-M1" BSP

S-550



Article	Capacity	L. hose	Ø hose	Inlet-Outlet
071-1518-600	95 l/min	without hose	-	F1"-M1" BSP
071-1518-520	83 l/min	20 m	3/4"- 19x27	F1"-M1" BSP
071-1518-615	90 l/min	15 m	1" - 25x35	F1"-M1" BSP

S-555



## OVERALL DIMENSIONS SWIVELLING VERSION

Mod.	A	B	C	D	E	F	G	H	Kg	m³	Box
S-550	200	150	225	270	120	572	550	680	23,00<45,00	0,130	1
S-555	250	200	225	270	170	572	550	680	27,00<54,00	0,150	1

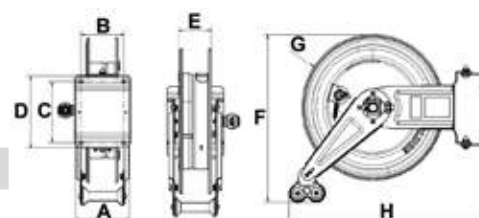

# FIXED AUTOMATIC HOSE REELS IN PAINTED STEEL WITHOUT HOSE

## F-400



Article	Fluid dispensed	90°swivelling joint	Seals	Inlet-Outlet
070-1201-300	Air-Water 20 bar	brass	Viton®	F3/8"-M3/8" BSP
070-1201-400	Air-Water 20 bar	brass	Viton®	F1/2"-M1/2" BSP
070-1205-300	Water 150 °C 400 bar	stainless steel	Viton®	F3/8"-M3/8" BSP
070-1205-400	Water 150 °C 400 bar	stainless steel	Viton®	F1/2"-M1/2" BSP
070-1206-400	Oil 160 bar	galvanized steel	NBR	F1/2"-M1/2" BSP
070-1207-200	Grease 600 bar	galvanized steel	polyurethane	M1/4"-M1/4" BSP
070-1207-300	Grease 600 bar	galvanized steel	polyurethane	M3/8"-M3/8" BSP
070-1207-400	Grease 500 bar	galvanized steel	polyurethane	M1/2"-M1/2" BSP
070-1209-400	Antifreeze-Windscreen 20 bar	acciaio inox	Viton®	F1/2"-M1/2" BSP

## F-460



Article	Fluid dispensed	90°swivelling joint	Seals	Inlet-Outlet
070-1301-400	Air-Water 20 bar	brass	Viton®	F1/2"-M1/2" BSP
070-1305-300	Water 150 °C 400 bar	stainless steel	Viton®	F3/8"-M3/8" BSP
070-1305-400	Water 150 °C 400 bar	stainless steel	Viton®	F1/2"-M1/2" BSP
070-1306-400	Oil 160 bar	galvanized steel	NBR	F1/2"-M1/2" BSP
070-1307-200	Grease 600 bar	galvanized steel	polyurethane	M1/4"-M1/4" BSP
070-1307-300	Grease 600 bar	galvanized steel	polyurethane	M3/8"-M3/8" BSP
070-1307-400	Grease 500 bar	galvanized steel	polyurethane	M1/2"-M1/2" BSP
070-1309-400	Antifreeze-Windscreen 20 bar	stainless steel	Viton®	F1/2"-M1/2" BSP

## F-550



Article	Fluid dispensed	90°swivelling joint	Seals	Inlet-Outlet
070-1401-400	Air-Water 20 bar	brass	Viton®	F1/2"-M1/2" BSP
070-1405-300	Water 150 °C 400 bar	stainless steel	Viton®	F3/8"-M3/8" BSP
070-1405-400	Water 150 °C 400 bar	stainless steel	Viton®	F1/2"-M1/2" BSP
070-1406-400	Oil 160 bar	galvanized steel	NBR	F1/2"-M1/2" BSP
070-1407-300	Grease 600 bar	galvanized steel	polyurethane	M3/8"-M3/8" BSP
070-1407-400	Grease 500 bar	galvanized steel	polyurethane	M1/2"-M1/2" BSP
070-1408-600	Diesel 10 bar	galvanized steel	Viton®	F1"-M1" BSP
070-1409-500	AdBlue® 20 bar	stainless steel	Viton®	F1"-M3/4" BSP

## F-555



Article	Fluid dispensed	90°swivelling joint	Seals	Inlet-Outlet
070-1502-400	Air-Water 20 bar	brass	Viton®	F1/2"-M1/2" BSP
070-1502-600	Air-Water 20 bar	brass	Viton®	F1"-M1" BSP
070-1505-300	Water 150 °C 400 bar	stainless steel	Viton®	F3/8"-M3/8" BSP
070-1505-400	Water 150 °C 400 bar	stainless steel	Viton®	F1/2"-M1/2" BSP
070-1506-400	Oil 160 bar	galvanized steel	NBR	F1/2"-M1/2" BSP
070-1506-500	Oil 160 bar	galvanized steel	NBR	F3/4"-M3/4" BSP
070-1506-600	Oil 160 bar	galvanized steel	NBR	F1"-M1" BSP
070-1507-300	Grease 600 bar	galvanized steel	polyurethane	M3/8"-M3/8" BSP
070-1507-400	Grease 500 bar	galvanized steel	polyurethane	M1/2"-M1/2" BSP
070-1508-600	Diesel 10 bar	galvanized steel	Viton®	F1"-M1" BSP



## F-560

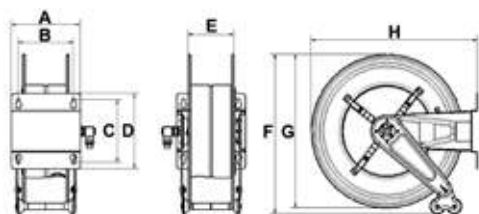

Article	Fluid dispensed	90°swivelling joint	Seals	Inlet-Outlet
070-1602-600	Air-Water 20 bar	brass	Viton®	F1"-M1" BSP
070-1605-400	Water 150 °C 400 bar	stainless steel	Viton®	F1/2"-M1/2" BSP
070-1606-500	Oil 160 bar	galvanized steel	NBR	F3/4"-M3/4" BSP
070-1606-600	Oil 160 bar	galvanized steel	NBR	F1"-M1" BSP
070-1608-600	Diesel 10 bar	galvanized steel	Viton®	F1"-M1" BSP

### OVERALL DIMENSIONS FIXED VERSION





Mod.	A	B	C	D	E	F	G	H			
F-400	158	120	168	192	95	460	400	435	12,50	0,084	1
F-460	158	120	168	192	95	490	460	490	16,50	0,094	1
F-550	200	150	225	270	120	590	550	600	22,00	0,130	1
F-555	250	200	225	270	170	590	550	600	26,00	0,150	1
F-560	440	390	225	270	360	590	550	600	33,00	0,240	1

# SWIVELLING AUTOMATIC HOSE REELS IN PAINTED STEEL WITHOUT HOSE

Article	Fluid dispensed	90° swivelling joint	Seals	Inlet-Outlet	S-400
071-1201-300	Air-Water 20 bar	brass	Viton®	F3/8" - M3/8" BSP	
071-1201-400	Air-Water 20 bar	brass	Viton®	F1/2" - M1/2" BSP	
071-1205-300	Water 150 °C 400 bar	stainless steel	Viton®	F3/8" - M3/8" BSP	
071-1205-400	Water 150 °C 400 bar	stainless steel	Viton®	F1/2" - M1/2" BSP	
071-1206-400	Oil 160 bar	galvanized steel	NBR	F1/2" - M1/2" BSP	
071-1207-200	Grease 600 bar	galvanized steel	polyurethane	M1/4" - M1/4" BSP	
071-1207-300	Grease 600 bar	galvanized steel	polyurethane	M3/8" - M3/8" BSP	
071-1207-400	Grease 500 bar	galvanized steel	polyurethane	M1/2" - M1/2" BSP	
071-1209-400	Antifreeze-Windscreen 20 bar	stainless steel	Viton®	F1/2" - M1/2" BSP	

Article	Fluid dispensed	90° swivelling joint	Seals	Inlet-Outlet	S-460
071-1301-400	Air-Water 20 bar	brass	Viton®	F1/2" - M1/2" BSP	
071-1305-300	Water 150 °C 400 bar	stainless steel	Viton®	F3/8" - M3/8" BSP	
071-1305-400	Water 150 °C 400 bar	stainless steel	Viton®	F1/2" - M1/2" BSP	
071-1306-400	Oil 160 bar	galvanized steel	NBR	F1/2" - M1/2" BSP	
071-1307-200	Grease 600 bar	galvanized steel	polyurethane	M1/4" - M1/4" BSP	
071-1307-300	Grease 600 bar	galvanized steel	polyurethane	M3/8" - M3/8" BSP	
071-1307-400	Grease 500 bar	galvanized steel	polyurethane	M1/2" - M1/2" BSP	
071-1309-400	Antifreeze-Windscreen 20 bar	acciaio inox	Viton®	F1/2" - M1/2" BSP	

Article	Fluid dispensed	90° swivelling joint	Seals	Inlet-Outlet	S-550
071-1401-400	Air-Water 20 bar	brass	Viton®	F1/2" - M1/2" BSP	
071-1405-300	Water 150 °C 400 bar	stainless steel	Viton®	F3/8" - M3/8" BSP	
071-1405-400	Water 150 °C 400 bar	stainless steel	Viton®	F1/2" - M1/2" BSP	
071-1406-400	Oil 160 bar	galvanized steel	NBR	F1/2" - M1/2" BSP	
071-1407-300	Grease 600 bar	galvanized steel	polyurethane	M3/8" - M3/8" BSP	
071-1407-400	Grease 500 bar	galvanized steel	polyurethane	M1/2" - M1/2" BSP	
071-1408-600	Diesel 10 bar	galvanized steel	Viton®	F1" - M1" BSP	
071-1409-500	AdBlue® 20 bar	stainless steel	Viton®	F3/4" - M3/4" BSP	

Article	Fluid dispensed	90° swivelling joint	Seals	Inlet-Outlet	S-555
071-1502-400	Air-Water 20 bar	brass	Viton®	F1/2" - M1/2" BSP	
071-1502-600	Air-Water 20 bar	brass	Viton®	F1" - M1" BSP	
071-1505-300	Water 150 °C 400 bar	stainless steel	Viton®	F3/8" - M3/8" BSP	
071-1505-400	Water 150 °C 400 bar	stainless steel	Viton®	F1/2" - M1/2" BSP	
071-1506-400	Oil 160 bar	galvanized steel	NBR	F1/2" - M1/2" BSP	
071-1506-500	Oil 160 bar	galvanized steel	NBR	F3/4" - M3/4" BSP	
071-1506-600	Oil 160 bar	galvanized steel	NBR	F1" - M1" BSP	
071-1507-300	Grease 600 bar	galvanized steel	polyurethane	M3/8" - M3/8" BSP	
071-1507-400	Grease 500 bar	galvanized steel	polyurethane	M1/2" - M1/2" BSP	
071-1508-600	Diesel 10 bar	galvanized steel	Viton®	F1" - M1" BSP	

## OVERALL DIMENSIONS SWIVELLING VERSION

Mod.	A	B	C	D	E	F	G	H
S-400	150	120	168	196	95	460	400	550
S-460	150	120	168	196	95	490	460	575
S-550	200	150	225	270	120	572	550	680
S-555	250	200	225	270	170	572	550	680

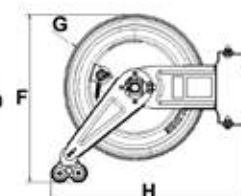
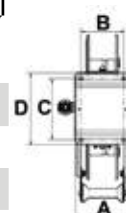

# FIXED AUTOMATIC HOSE REELS IN AISI 304 STAINLESS STEEL FOR AIR-WATER 20 bar

Equipped with:

- Blue polyurethane ether-based hoses
- Nickel-plated brass or galvanized steel connections
- Brass 90° swivelling joint
- Viton® seals



FX-400	Article	L. hose	Ø hose	Max pressure	Inlet-Outlet
	070-2201-300	without hose	-	-	F1/2"-M3/8" BSP
	070-2201-400	without hose	-	-	F1/2"-M1/2" BSP
	070-2201-215	15 m	8x12	20 bar	F1/2"G-M1/4" G gir.
	070-2201-220	20 m	8x12	20 bar	F1/2"G-M1/4" G gir.
	070-2201-310	10 m	10x14	20 bar	F1/2"-M3/8" BSP
	070-2201-315	15 m	10x14	20 bar	F1/2"-M3/8" BSP
	070-2201-410	10 m	13x19	20 bar	F1/2"-M1/2" BSP





FX-460	Article	L. hose	Ø hose	Max pressure	Inlet-Outlet
	070-2301-300	without hose	-	-	F1/2"-M3/8" BSP
	070-2301-400	without hose	-	-	F1/2"-M1/2" BSP
	070-2301-320	20 m	10X14	20 bar	F1/2"-M3/8" BSP
	070-2301-415	15 m	13X19	20 bar	F1/2"-M1/2" BSP
	070-2301-418	18 m	13X19	20 bar	F1/2"-M1/2" BSP

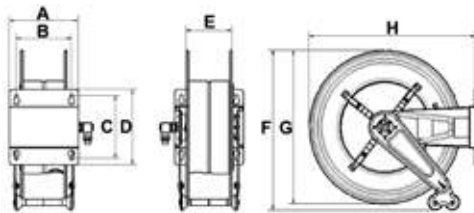

FX-550	Article	L. hose	Ø hose	Max pressure	Inlet-Outlet
	070-2401-400	without hose	-	-	F1/2"-M1/2" BSP
	070-2401-420	20 m	13X19	20 bar	F1/2"-M1/2" BSP
	070-2401-425	25 m	13X19	20 bar	F1/2"-M1/2" BSP



## OVERALL DIMENSIONS FIXED VERSION

Mod.	A	B	C	D	E	F	G	H			
FX-400	158	120	168	192	95	460	400	435	12,50<19,50	0,084	1
FX-460	158	120	168	192	95	490	460	490	16,50<23,00	0,094	1
FX-550	200	150	225	270	120	590	550	600	22,00<28,00	0,130	1

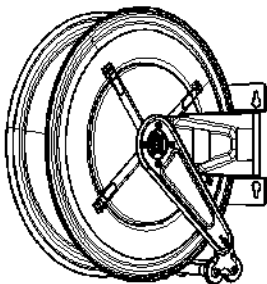

Wall application with inside output hose

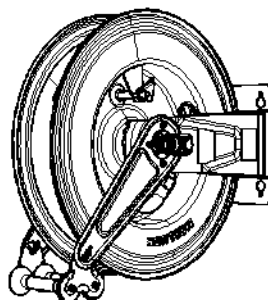

Wall application with external output hose

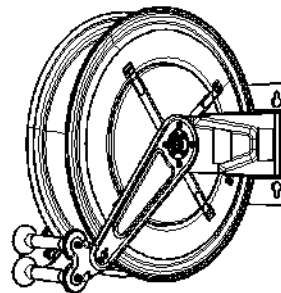

Wall and ceiling application with frontal output hose

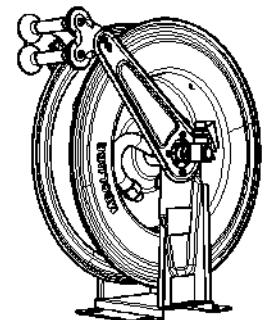

Application bench with frontal output hose

# SWIVELLING AUTOMATIC HOSE REELS IN AISI 304 STAINLESS STEEL FOR AIR-WATER 20 bar

Equipped with:



- Blue polyurethane ether-based hoses
- Nickel-plated brass or galvanized steel connections
- Brass 90° swivelling joint
- Viton® seals

Article	L. hose	Ø hose	Max pressure	Inlet-Outlet	SX-400
071-2201-300	without hose	-	-	F1/2" - M3/8" BSP	
071-2201-400	without hose	-	-	F1/2" - M1/2" BSP	
071-2201-215	15 m	8x12	20 bar	F1/2"G - M1/4" G gir.	
071-2201-220	20 m	8x12	20 bar	F1/2"G - M1/4" G gir.	
071-2201-310	10 m	10x14	20 bar	F1/2" - M3/8" BSP	
071-2201-315	15 m	10x14	20 bar	F1/2" - M3/8" BSP	
071-2201-410	10 m	13x19	20 bar	F1/2" - M1/2" BSP	

Article	L. hose	Ø hose	Max pressure	Inlet-Outlet	SX-460
071-2301-300	without hose	-	-	F1/2" - M3/8" BSP	
071-2301-400	without hose	-	-	F1/2" - M1/2" BSP	
071-2301-320	20 m	10x14	20 bar	F1/2" - M3/8" BSP	
071-2301-415	15 m	13x19	20 bar	F1/2" - M1/2" BSP	
071-2301-418	18 m	13x19	20 bar	F1/2" - M1/2" BSP	

Article	L. hose	Ø hose	Max pressure	Inlet-Outlet	SX-550
071-2401-400	without hose	-	-	F1/2" - M1/2" BSP	
071-2401-420	20 m	13x19	20 bar	F1/2" - M1/2" BSP	
071-2401-425	25 m	13x19	20 bar	F1/2" - M1/2" BSP	

## OVERALL DIMENSIONS SWIVELLING VERSION

Mod.	A	B	C	D	E	F	G	H			
SX-400	150	120	168	196	95	460	400	550	13,50<20,50	0,084	1
SX-460	150	120	168	196	95	490	460	575	17,50<24,00	0,094	1
SX-550	200	150	225	270	120	572	550	680	23,00<29,00	0,130	1

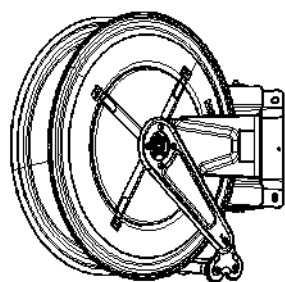
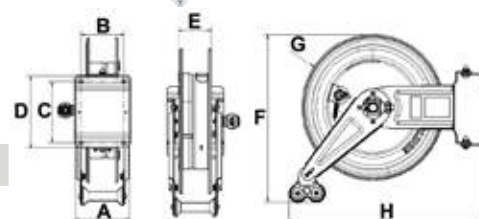

Wall application with inside output hose

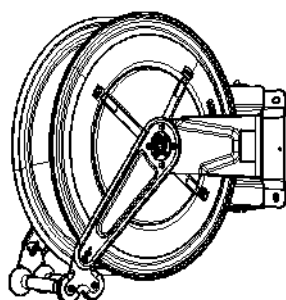

Wall application with external output hose

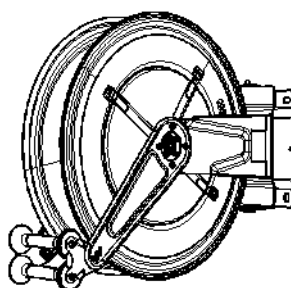

Wall and ceiling application with frontal outside hose

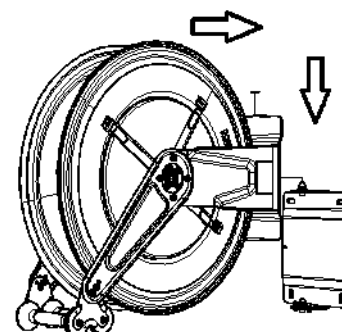

The insertion of the hose reel in the wall bracket is with quick disconnect coupling

# FIXED AUTOMATIC HOSE REELS IN AISI 304 STAINLESS STEEL FOR AIR-WATER FROM 20 TO 28 bar

Equipped with:

- Black synthetic rubber hoses R6, Galvanized steel connections
- Brass 90° swivelling joint, Viton® seals



**FX-400**

Article	L. hose	Ø hose	Max pressure	Inlet-Outlet
070-2201-300	without hose	-	-	F1/2"-M3/8" BSP
070-2201-400	without hose	-	-	F1/2"-M1/2" BSP
070-2202-212	12 m	5/16"	28 bar	F1/2"-M1/4" BSP
070-2202-218	18 m	5/16"	28 bar	F1/2"-M1/4" BSP
070-2202-310	10 m	3/8"	28 bar	F1/2"-M3/8" BSP
070-2202-315	15 m	3/8"	28 bar	F1/2"-M3/8" BSP
070-2202-410	10 m	1/2"	28 bar	F1/2"-M1/2" BSP



**FX-460**

Article	L. hose	Ø hose	Max pressure	Inlet-Outlet
070-2301-300	without hose	-	-	F1/2"-M3/8" BSP
070-2301-400	without hose	-	-	F1/2"-M1/2" BSP
070-2302-318	18 m	3/8"	28 bar	F1/2"-M3/8" BSP
070-2302-320	20 m	3/8"	28 bar	F1/2"-M3/8" BSP
070-2302-415	15 m	1/2"	28 bar	F1/2"-M1/2" BSP
070-2302-418	18 m	1/2"	28 bar	F1/2"-M1/2" BSP



**FX-550**

Article	L. hose	Ø hose	Max pressure	Inlet-Outlet
070-2401-400	without hose	-	-	F1/2"-M1/2" BSP
070-2402-500	without hose	-	-	F1"-M3/4" BSP
070-2402-420	20 m	1/2"	28 bar	F1/2"-M1/2" BSP
070-2402-425	25 m	1/2"	28 bar	F1/2"-M1/2" BSP
070-2402-515	15 m	3/4"	21 bar	F1"-M3/4" BSP



**FX-555**



Article	L. hose	Ø hose	Max pressure	Inlet-Outlet
070-2502-400	without hose	-	-	F1/2"-M1/2" BSP
070-2502-500	without hose	-	-	F1"-M3/4" BSP
070-2502-600	without hose	-	-	F1"-M1" BSP
070-2502-430	30 m	1/2"	28 bar	F1/2"-M1/2" BSP
070-2502-520	20 m	3/4"	21 bar	F1"-M3/4" BSP
070-2502-615	15 m	1"	20 bar	F1"-M1" BSP



**FX-560**

Article	L. hose	Ø hose	Max pressure	Inlet-Outlet
070-2602-400	without hose	-	-	F1/2"-M1/2" BSP
070-2602-500	without hose	-	-	F1"-M3/4" BSP
070-2602-600	without hose	-	-	F1"-M1" BSP
070-2602-440	40 m	1/2"	28 bar	F1/2"-M1/2" BSP
070-2602-530	30 m	3/4"	21 bar	F1"-M3/4" BSP
070-2602-540	40 m	3/4"	21 bar	F1"-M3/4" BSP
070-2602-620	20 m	1"	20 bar	F1"-M1" BSP
070-2602-630	30 m	1"	20 bar	F1"-M1" BSP

## OVERALL DIMENSIONS FIXED VERSION

Mod.	A	B	C	D	E	F	G	H			
FX-400	158	120	168	192	95	460	400	435	12,50<19,50	0,084	1
FX-460	158	120	168	192	95	490	460	490	16,50<23,00	0,094	1
FX-550	200	150	225	270	120	590	550	600	22,00<45,00	0,130	1
FX-555	250	200	225	270	170	590	550	600	26,00<53,00	0,150	1
FX-560	440	390	225	270	360	590	550	600	33,00<83,00	0,240	1

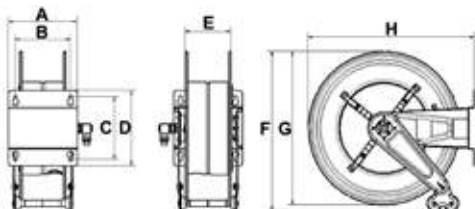



# SWIVELLING AUTOMATIC HOSE REELS IN AISI 304 STAINLESS STEEL FOR AIR-WATER FROM 20 TO 28 bar

Equipped with:

- Black synthetic rubber hoses R6, Galvanized steel connections
- Brass 90° swivelling joint, Viton® seals



Article	L. hose	Ø hose	Max pressure	Inlet-Outlet	SX-400
071-2201-300	without hose	-	-	F1/2"-M3/8" BSP	
071-2201-400	without hose	-	-	F1/2"-M1/2" BSP	
071-2202-212	12 m	5/16"	28 bar	F1/2"-M1/4" BSP	
071-2202-218	18 m	5/16"	28 bar	F1/2"-M1/4" BSP	
071-2202-310	10 m	3/8"	28 bar	F1/2"-M3/8" BSP	
071-2202-315	15 m	3/8"	28 bar	F1/2"-M3/8" BSP	
071-2202-410	10 m	1/2"	28 bar	F1/2"-M1/2" BSP	

Article	L. hose	Ø hose	Max pressure	Inlet-Outlet	SX-460
071-2301-300	without hose	-	-	F1/2"-M3/8" BSP	
071-2301-400	without hose	-	-	F1/2"-M1/2" BSP	
071-2302-318	18 m	3/8"	28 bar	F1/2"-M3/8" BSP	
071-2302-320	20 m	3/8"	28 bar	F1/2"-M3/8" BSP	
071-2302-415	15 m	1/2"	28 bar	F1/2"-M1/2" BSP	
071-2302-418	18 m	1/2"	28 bar	F1/2"-M1/2" BSP	

Article	L. hose	Ø hose	Max pressure	Inlet-Outlet	SX-550
071-2401-400	without hose	-	-	F1/2"-M1/2" BSP	
071-2402-500	without hose	-	-	F1"-M3/4" BSP	
071-2402-420	20 m	1/2"	28 bar	F1/2"-M1/2" BSP	
071-2402-425	25 m	1/2"	28 bar	F1/2"-M1/2" BSP	
071-2402-515	15 m	3/4"	21 bar	F1"-M3/4" BSP	

Article	L. hose	Ø hose	Max pressure	Inlet-Outlet	SX-555
071-2502-400	without hose	-	-	F1/2"-M1/2" BSP	
071-2502-500	without hose	-	-	F1"-M3/4" BSP	
071-2502-600	without hose	-	-	F1"-M1" BSP	
071-2502-430	30 m	1/2"	28 bar	F1/2"-M1/2" BSP	
071-2502-520	20 m	3/4"	21 bar	F1"-M3/4" BSP	
071-2502-615	15 m	1"	20 bar	F1"-M1" BSP	

## OVERALL DIMENSIONS SWIVELLING VERSION

Mod.	A	B	C	D	E	F	G	H			
SX-400	150	120	168	196	95	460	400	550	13,50<20,50	0,084	1
SX-460	150	120	168	196	95	490	460	575	17,50<24,00	0,094	1
SX-550	200	150	225	270	120	572	550	680	23,00<45,00	0,130	1
SX-555	250	200	225	270	170	572	550	680	27,00<54,00	0,150	1

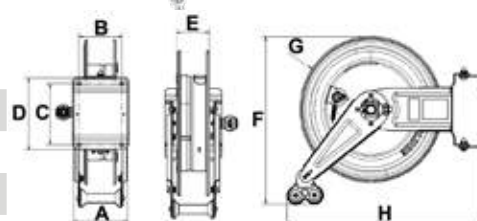

# FIXED AUTOMATIC HOSE REELS IN AISI 304 STAINLESS STEEL FOR WATER 150 °C 200 bar

Equipped with:

- Blue no trace synthetic rubber hoses 1SC
- Galvanized steel connections
- AISI 304 stainless steel 90° swivelling joint
- Viton® seals



**FX-400**

Article	L. hose	Ø hose	Max pressure	Inlet-Outlet
070-2205-300	without hose	-	-	F1/2"-M3/8" BSP
070-2205-400	without hose	-	-	F1/2"-M1/2" BSP
070-2204-210	10 m	5/16"	200 bar	F1/2"-F3/8" BSP
070-2204-215	15 m	5/16"	200 bar	F1/2"-F3/8" BSP
070-2204-310	10 m	3/8"	200 bar	F1/2"-F3/8" BSP
070-2204-410	10 m	1/2"	200 bar	F1/2"-F1/2" BSP



**FX-460**

Article	L. hose	Ø hose	Max pressure	Inlet-Outlet
070-2305-300	without hose	-	-	F1/2"-M3/8" BSP
070-2305-400	without hose	-	-	F1/2"-M1/2" BSP
070-2304-220	20 m	5/16"	200 bar	F1/2"-F3/8" BSP
070-2304-315	15 m	3/8"	200 bar	F1/2"-F3/8" BSP
070-2304-318	18 m	3/8"	200 bar	F1/2"-F3/8" BSP
070-2304-415	15 m	1/2"	200 bar	F1/2"-F1/2" BSP



**FX-550**

Article	L. hose	Ø hose	Max pressure	Inlet-Outlet
070-2405-300	without hose	-	-	F1/2"-M3/8" BSP
070-2405-400	without hose	-	-	F1/2"-M1/2" BSP
070-2404-320	20 m	3/8"	200 bar	F1/2"-F3/8" BSP
070-2404-325	25 m	3/8"	200 bar	F1/2"-F3/8" BSP
070-2404-420	20 m	1/2"	200 bar	F1/2"-F1/2" BSP
070-2404-425	25 m	1/2"	200 bar	F1/2"-F1/2" BSP



**FX-555**

Article	L. hose	Ø hose	Max pressure	Inlet-Outlet
070-2505-300	without hose	-	-	F1/2"-M3/8" BSP
070-2505-400	without hose	-	-	F1/2"-M1/2" BSP
070-2504-330	30 m	3/8"	200 bar	F1/2"-F3/8" BSP
070-2504-430	30 m	1/2"	200 bar	F1/2"-F1/2" BSP





**FX-560**

Article	L. hose	Ø hose	Max pressure	Inlet-Outlet
070-2605-400	without hose	-	-	F1/2"-M1/2" BSP
070-2604-340	40 m	3/8"	200 bar	F1/2"-F3/8" BSP
070-2604-350	50 m	3/8"	200 bar	F1/2"-F3/8" BSP
070-2604-440	40 m	1/2"	200 bar	F1/2"-F1/2" BSP

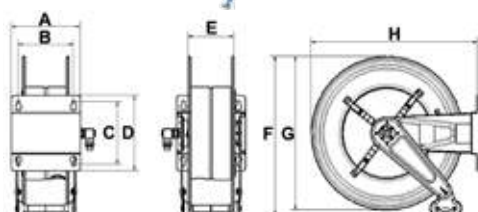
## OVERALL DIMENSIONS FIXED VERSION





Mod.	A	B	C	D	E	F	G	H			
FX-400	158	120	168	192	95	460	400	435	12,50<19,50	0,084	1
FX-460	158	120	168	192	95	490	460	490	16,50<23,00	0,094	1
FX-550	200	150	225	270	120	590	550	600	22,00<45,00	0,130	1
FX-555	250	200	225	270	170	590	550	600	26,00<53,00	0,150	1
FX-560	440	390	225	270	360	590	550	600	33,00<83,00	0,240	1

# SWIVELLING AUTOMATIC HOSE REELS IN AISI 304 STAINLESS STEEL FOR WATER 150 °C 200 bar

Equipped with:

- Blue no trace synthetic rubber hoses 1SC
- Galvanized steel connections
- AISI 304 stainless steel 90° swivelling joint
- Viton® seals

Article	L. hose	Ø hose	Max pressure	Inlet-Outlet	SX-400
071-2205-300	without hose	-	-	F1/2"-M3/8" BSP	
071-2205-400	without hose	-	-	F1/2"-M1/2" BSP	
071-2204-210	10 m	5/16"	200 bar	F1/2"-F3/8" BSP	
071-2204-215	15 m	5/16"	200 bar	F1/2"-F3/8" BSP	
071-2204-310	10 m	3/8"	200 bar	F1/2"-F3/8" BSP	
071-2204-410	10 m	1/2"	200 bar	F1/2"-F1/2" BSP	

Article	L. hose	Ø hose	Max pressure	Inlet-Outlet	SX-460
071-2305-300	without hose	-	-	F1/2"-M3/8" BSP	
071-2305-400	without hose	-	-	F1/2"-M1/2" BSP	
071-2304-220	20 m	5/16"	200 bar	F1/2"-F3/8" BSP	
071-2304-315	15 m	3/8"	200 bar	F1/2"-F3/8" BSP	
071-2304-318	18 m	3/8"	200 bar	F1/2"-F3/8" BSP	
071-2304-415	15 m	1/2"	200 bar	F1/2"-F1/2" BSP	

Article	L. hose	Ø hose	Max pressure	Inlet-Outlet	SX-550
071-2405-300	without hose	-	-	F1/2"-M3/8" BSP	
071-2405-400	without hose	-	-	F1/2"-M1/2" BSP	
071-2404-320	20 m	3/8"	200 bar	F1/2"-F3/8" BSP	
071-2404-325	25 m	3/8"	200 bar	F1/2"-F3/8" BSP	
071-2404-420	20 m	1/2"	200 bar	F1/2"-F1/2" BSP	
071-2404-425	25 m	1/2"	200 bar	F1/2"-F1/2" BSP	

Article	L. hose	Ø hose	Max pressure	Inlet-Outlet	SX-555
071-2505-300	without hose	-	-	F1/2"-M3/8" BSP	
071-2505-400	without hose	-	-	F1/2"-M1/2" BSP	
071-2504-330	30 m	3/8"	200 bar	F1/2"-F3/8" BSP	
071-2504-430	30 m	1/2"	200 bar	F1/2"-F1/2" BSP	

## OVERALL DIMENSIONS SWIVELLING VERSION

Mod.	A	B	C	D	E	F	G	H				
SX-400	150	120	168	196	95	460	400	550	13,50	<20,50	0,084	1
SX-460	150	120	168	196	95	490	460	575	17,50	<24,00	0,094	1
SX-550	200	150	225	270	120	572	550	680	23,00	<45,00	0,130	1
SX-555	250	200	225	270	170	572	550	680	27,00	<54,00	0,150	1

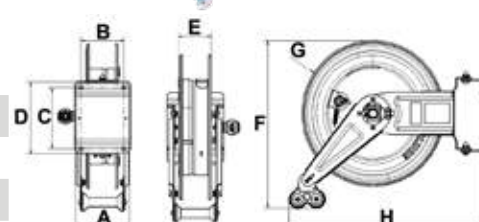

# FIXED AUTOMATIC HOSE REELS IN AISI 304 STAINLESS STEEL FOR WATER 150 °C 400 bar

Equipped with:

- Blue no trace synthetic rubber hoses 2SC
- Galvanized steel connections
- AISI 304 stainless steel 90° swivelling joint
- Viton® seals



**FX-400**

Article	L. hose	Ø hose	Max pressure	Inlet-Outlet
070-2205-300	without hose	-	-	F1/2"-M3/8" BSP
070-2205-400	without hose	-	-	F1/2"-M1/2" BSP
070-2205-210	10 m	5/16"	400 bar	F1/2"-F3/8" BSP
070-2205-215	15 m	5/16"	400 bar	F1/2"-F3/8" BSP
070-2205-310	10 m	3/8"	400 bar	F1/2"-F3/8" BSP
070-2205-410	10 m	1/2"	400 bar	F1/2"-F1/2" BSP



**FX-460**

Article	L. hose	Ø hose	Max pressure	Inlet-Outlet
070-2305-300	without hose	-	-	F1/2"-M3/8" BSP
070-2305-400	without hose	-	-	F1/2"-M1/2" BSP
070-2305-220	20 m	5/16"	400 bar	F1/2"-F3/8" BSP
070-2305-315	15 m	3/8"	400 bar	F1/2"-F3/8" BSP
070-2305-318	18 m	3/8"	400 bar	F1/2"-F3/8" BSP
070-2305-415	15 m	1/2"	400 bar	F1/2"-F1/2" BSP



**FX-550**

Articolo	L. tubo	Ø tubo	Pressione max	Entrata-Uscita
070-2405-300	without hose	-	-	F1/2"-M3/8" BSP
070-2405-400	without hose	-	-	F1/2"-M1/2" BSP
070-2405-320	20 m	3/8"	400 bar	F1/2"-F3/8" BSP
070-2405-325	25 m	3/8"	400 bar	F1/2"-F3/8" BSP
070-2405-420	20 m	1/2"	400 bar	F1/2"-F1/2" BSP
070-2405-425	25 m	1/2"	400 bar	F1/2"-F1/2" BSP



**FX-555**

Article	L. hose	Ø hose	Max pressure	Inlet-Outlet
070-2505-300	without hose	-	-	F1/2"-M3/8" BSP
070-2505-400	without hose	-	-	F1/2"-M1/2" BSP
070-2505-330	30 m	3/8"	400 bar	F1/2"-F3/8" BSP
070-2505-430	30 m	1/2"	400 bar	F1/2"-F1/2" BSP



**FX-560**

Article	L. hose	Ø hose	Max pressure	Inlet-Outlet
070-2605-400	without hose	-	-	F1/2"-M1/2" BSP
070-2605-340	40 m	3/8"	400 bar	F1/2"-F3/8" BSP
070-2605-350	50 m	3/8"	400 bar	F1/2"-F3/8" BSP
070-2605-440	40 m	1/2"	400 bar	F1/2"-F1/2" BSP

## OVERALL DIMENSIONS FIXED VERSION

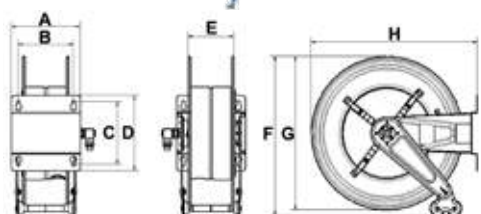

Mod.	A	B	C	D	E	F	G	H			
FX-400	158	120	168	192	95	460	400	435	12,50<19,50	0,084	1
FX-460	158	120	168	192	95	490	460	490	16,50<23,00	0,094	1
FX-550	200	150	225	270	120	590	550	600	22,00<45,00	0,130	1
FX-555	250	200	225	270	170	590	550	600	26,00<53,00	0,150	1
FX-560	440	390	225	270	360	590	550	600	33,00<83,00	0,240	1

# SWIVELLING AUTOMATIC HOSE REELS IN AISI 304 STAINLESS STEEL FOR WATER 150 °C 400 bar

Equipped with:

- Blue no trace synthetic rubber hoses 2SC
- Galvanized steel connections
- AISI 304 stainless steel 90° swivelling joint
- Viton® seals

Article	L. hose	Ø hose	Max pressure	Inlet-Outlet	SX-400
071-2205-300	without hose	-	-	F1/2"-M3/8" BSP	
071-2205-400	without hose	-	-	F1/2"-M1/2" BSP	
071-2205-210	10 m	5/16"	400 bar	F1/2"-F3/8" BSP	
071-2205-215	15 m	5/16"	400 bar	F1/2"-F3/8" BSP	
071-2205-310	10 m	3/8"	400 bar	F1/2"-F3/8" BSP	
071-2205-410	10 m	1/2"	400 bar	F1/2"-F1/2" BSP	



Article	L. hose	Ø hose	Max pressure	Inlet-Outlet	SX-460
071-2305-300	without hose	-	-	F1/2"-M3/8" BSP	
071-2305-400	without hose	-	-	F1/2"-M1/2" BSP	
071-2305-220	20 m	5/16"	400 bar	F1/2"-F3/8" BSP	
071-2305-315	15 m	3/8"	400 bar	F1/2"-F3/8" BSP	
071-2305-318	18 m	3/8"	400 bar	F1/2"-F3/8" BSP	
071-2305-415	15 m	1/2"	400 bar	F1/2"-F1/2" BSP	





Article	L. hose	Ø hose	Max pressure	Inlet-Outlet	SX-550
071-2405-300	without hose	-	-	F1/2"-M3/8" BSP	
071-2405-400	without hose	-	-	F1/2"-M1/2" BSP	
071-2405-320	20 m	3/8"	400 bar	F1/2"-F3/8" BSP	
071-2405-325	25 m	3/8"	400 bar	F1/2"-F3/8" BSP	
071-2405-420	20 m	1/2"	400 bar	F1/2"-F1/2" BSP	
071-2405-425	25 m	1/2"	400 bar	F1/2"-F1/2" BSP	



Article	L. hose	Ø hose	Max pressure	Inlet-Outlet	SX-555
071-2505-300	without hose	-	-	F1/2"-M3/8" BSP	
071-2505-400	without hose	-	-	F1/2"-M1/2" BSP	
071-2505-330	30 m	3/8"	400 bar	F1/2"-F3/8" BSP	
071-2505-430	30 m	1/2"	400 bar	F1/2"-F1/2" BSP	



## OVERALL DIMENSIONS SWIVELLING VERSION

Mod.	A	B	C	D	E	F	G	H			
SX-400	150	120	168	196	95	460	400	550	13,50<20,50	0,084	1
SX-460	150	120	168	196	95	490	460	575	17,50<24,00	0,094	1
SX-550	200	150	225	270	120	572	550	680	23,00<45,00	0,130	1
SX-555	250	200	225	270	170	572	550	680	27,00<54,00	0,150	1

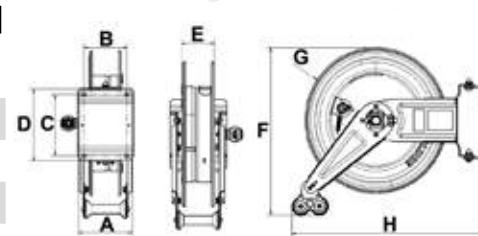

# FIXED AUTOMATIC HOSE REELS IN AISI 304 STAINLESS STEEL FOR ANTIFREEZE - WINDSCREEN - AdBlue® 20 bar

Equipped with:

- Black antistatic synthetic rubber EPDM hoses
- AISI 316 stainless steel connections
- AISI 316 stainless steel 90° swivelling joint
- Viton® seals



FX-400	Article	L. hose	Ø hose	Max pressure	Inlet-Outlet
	070-2209-400	without hose	-	-	F1/2"-M1/2" BSP
	070-2209-410	10 m	1/2"	20 bar	F1/2"-M1/2" BSP



FX-460	Article	L. hose	Ø hose	Max pressure	Inlet-Outlet
	070-2309-400	without hose	-	-	F1/2"-M1/2" BSP
	070-2309-415	15 m	1/2"	20 bar	F1/2"-M1/2" BSP







FX-550	Article	L. hose	Ø hose	Max pressure	Inlet-Outlet
	070-2409-400	without hose	-	-	F1/2"-M1/2" BSP
	070-2409-500	without hose	-	-	F1"-M3/4" BSP
	070-2409-420	20 m	1/2"	20 bar	F1/2"-M1/2" BSP
	070-2409-425	25 m	1/2"	20 bar	F1/2"-M 1/2" BSP
	070-2409-510	10 m	3/4"	20 bar	F1"-M3/4" BSP
	070-2409-515	15 m	3/4"	20 bar	F1"-M3/4" BSP

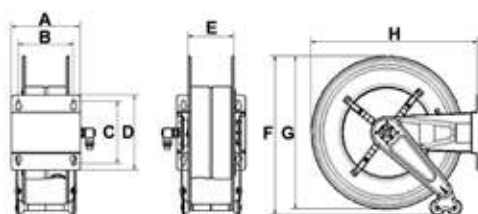

FX-555	Article	L. hose	Ø hose	Max pressure	Inlet-Outlet
	070-2509-500	without hose	-	-	F1"-M3/4" BSP
	070-2509-520	20 m	3/4"	20 bar	F1"-M3/4" BSP

## OVERALL DIMENSIONS FIXED VERSION



Mod.	A	B	C	D	E	F	G	H			
FX-400	158	120	168	192	95	460	400	435	12,50<19,50	0,084	1
FX-460	158	120	168	192	95	490	460	490	16,50<23,00	0,094	1
FX-550	200	150	225	270	120	590	550	600	22,00<45,00	0,130	1
FX-555	250	200	225	270	170	590	550	600	26,00<53,00	0,150	1

# SWIVELLING AUTOMATIC HOSE REELS IN AISI 304 STAINLESS STEEL FOR ANTIFREEZE - WINDSCREEN - AdBlue® 20 bar

Equipped with:

- Black antistatic synthetic rubber EPDM hoses
- AISI 316 stainless steel connections
- AISI 316 stainless steel 90° swivelling joint
- Viton® seals

Article	L. hose	Ø hose	Max pressure	Inlet-Outlet	SX-400
071-2209-400	without hose	-	-	F1/2"-M1/2" BSP	
071-2209-410	10 m	1/2"	20 bar	F1/2"-M1/2" BSP	



Article	L. hose	Ø hose	Max pressure	Inlet-Outlet	SX-460
071-2309-400	without hose	-	-	F1/2"-M1/2" BSP	
071-2309-415	15 m	1/2"	20 bar	F1/2"-M1/2" BSP	





Article	L. hose	Ø hose	Max pressure	Inlet-Outlet	SX-550
071-2409-400	without hose	-	-	F1/2"-M1/2" BSP	
071-2409-500	without hose	-	-	F1"-M3/4" BSP	
071-2409-420	20 m	1/2"	20 bar	F1/2"-M1/2" BSP	
071-2409-425	25 m	1/2"	20 bar	F1/2"-M 1/2" BSP	
071-2409-510	10 m	3/4"	20 bar	F1"-M3/4" BSP	
071-2409-515	15 m	3/4"	20 bar	F1"-M3/4" BSP	



Article	L. hose	Ø hose	Max pressure	Inlet-Outlet	SX-555
071-2509-500	without hose	-	-	F1"-M3/4" BSP	
071-2509-520	20 m	3/4"	20 bar	F1"-M3/4" BSP	



## OVERALL DIMENSIONS SWIVELLING VERSION

Mod.	A	B	C	D	E	F	G	H			
SX-400	150	120	168	196	95	460	400	550	13,50<20,50	0,084	1
SX-460	150	120	168	196	95	490	460	575	17,50<24,00	0,094	1
SX-550	200	150	225	270	120	572	550	680	23,00<45,00	0,130	1
SX-555	250	200	225	270	170	572	550	680	27,00<54,00	0,150	1

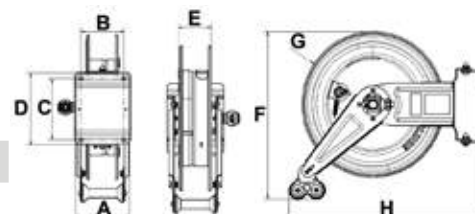

# FIXED AUTOMATIC HOSE REELS IN AISI 304 STAINLESS STEEL FOR DIESEL 10 bar

Equipped with:

- Black antistatic rubber hoses
- Galvanized steel connections
- Galvanized steel - anodized aluminum 90° swivelling joint
- Viton® seals



**FX-460**

Article	Capacity	L. hose	Ø hose	Inlet-Outlet
070-2308-500	80 l/min	without hose	-	F1"-M3/4"BSP
070-2308-508	80 l/min	8 m	3/4"- 19x27	F1"-M1" BSP



**FX-550**

Article	Capacity	L. hose	Ø hose	Inlet-Outlet
070-2408-600	95 l/min	without hose	-	F1"-M1" BSP
070-2408-510	90 l/min	10 m	3/4"- 19x27	F1"-M1" BSP
070-2408-515	85 l/min	15m	3/4"- 19x27	F1"-M1" BSP
070-2408-610	95 l/min	10m	1" - 25x35	F1"-M1" BSP



**FX-555**

Article	Capacity	L. hose	Ø hose	Inlet-Outlet
070-2508-600	95 l/min	without hose	-	F1"-M1" BSP
070-2508-520	83 l/min	20 m	3/4"- 19x27	F1"-M1" BSP
070-2508-615	90 l/min	15 m	1"- 25x35	F1"-M1" BSP





**FX-560**

Article	Capacity	L. hose	Ø hose	Inlet-Outlet
070-2608-600	95 l/min	without hose	-	F1"-M1" BSP
070-2608-530	80 l/min	30 m	3/4"- 19x27	F1"-M1" BSP
070-2608-540	75 l/min	40 m	3/4"- 19x27	F1"-M1" BSP
070-2608-620	87 l/min	20 m	1"- 25x35	F1"-M1" BSP
070-2608-630	85 l/min	30 m	1"- 25x35	F1"-M1" BSP

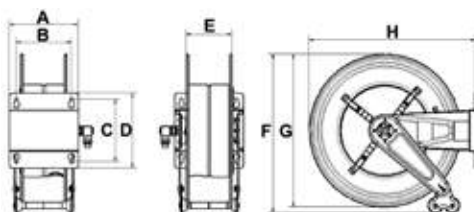
## OVERALL DIMENSIONS FIXED VERSION



Mod.	A	B	C	D	E	F	G	H			
FX-460	158	120	168	192	95	490	460	490	16,50<23,00	0,094	1
FX-550	200	150	225	270	120	590	550	600	22,00<45,00	0,130	1
FX-555	250	200	225	270	170	590	550	600	26,00<53,00	0,150	1
FX-560	440	390	225	270	360	590	550	600	33,00<83,00	0,240	1

# SWIVELLING AUTOMATIC HOSE REELS IN AISI 304 STAINLESS STEEL FOR DIESEL 10 bar

Equipped with:

- Black antistatic rubber hoses
- Galvanized steel connections
- Galvanized steel - anodized aluminum 90° swivelling joint
- Viton® seals

Article	Capacity	L. hose	Ø hose	Inlet-Outlet	SX-460
071-2308-500	80 l/min	without hose	-	F1"-M3/4" BSP	
071-2308-508	80 l/min	8 m	3/4"- 19x27	F1"-M1" BSP	



Article	Capacity	L. hose	Ø hose	Inlet-Outlet	SX-550
071-2408-600	95 l/min	without hose	-	F1"G-M1" BSP	
071-2408-510	90 l/min	10 m	3/4"- 19x27	F1"-M1" BSP	
071-2408-515	85 l/min	15m	3/4"- 19x27	F1"-M1" BSP	
071-2408-610	95 l/min	10m	1" - 25x35	F1"-M1" BSP	



Article	Capacity	L. hose	Ø hose	Inlet-Outlet	SX-555
071-2508-600	95 l/min	without hose	-	F1"-M1" BSP	
071-2508-520	83 l/min	20 m	3/4"- 19x27	F1"-M1" BSP	
071-2508-615	90 l/min	15 m	1"- 25x35	F1"-M1" BSP	



## OVERALL DIMENSIONS SWIVELLING VERSION

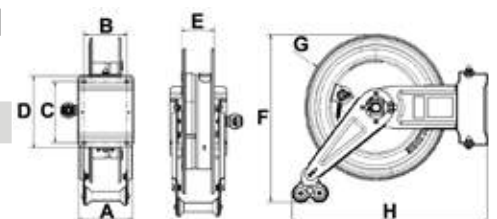

Mod.	A	B	C	D	E	F	G	H			
SX-460	150	120	168	196	95	490	460	575	17,50<24,00	0,094	1
SX-550	200	150	225	270	120	572	550	680	23,00<45,00	0,130	1
SX-555	250	200	225	270	170	572	550	680	27,00<54,00	0,150	1



# FIXED AUTOMATIC HOSE REELS IN AISI 304 STAINLESS STEEL FOR GASOLINE 16 bar

Equipped with:

- Black antistatic synthetic rubber hoses steel wire helix with high strength synthetic textile plies, copper wire
- Reference regulations: EN 1761 - EN 12115 ATEX (EX ZONE)
- Self-extinguishing according to: TRbf 131/2
- Galvanized steel connections
- Stainless steel 90° swivelling joint - Viton® seals
- Compliant with ATEX directive (see ATEX regulation at page 390)



 II 2 G Ex h IIB T4 Gb X  
 II 2 D Ex h IIIC T4 Db



FX-550

Article	Capacity	L. hose	Ø hose	Inlet-Outlet
070-2418-600	95 l/min	without hose	-	F1"-M1"BSP
070-2418-510	90 l/min	10 m	3/4"- 19x27	F1"-M1" BSP
070-2418-515	85 l/min	15 m	3/4"- 19x27	F1"-M1" BSP
070-2418-610	95 l/min	10 m	1" - 25x35	F1"-M1" BSP



FX-555

Article	Capacity	L. hose	Ø hose	Inlet-Outlet
070-2518-600	95 l/min	without hose	-	F1"-M1" BSP
070-2518-520	83 l/min	20 m	3/4"- 19x27	F1"-M1" BSP
070-2518-615	90 l/min	15 m	1" - 25x35	F1"-M1" BSP



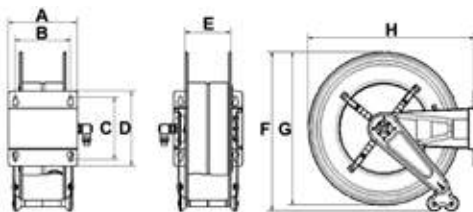

FX-560

Article	Capacity	L. hose	Ø hose	Inlet-Outlet
070-2618-600	95 l/min	without hose	-	F1"-M1" BSP
070-2618-530	80 l/min	30 m	3/4"- 19x27	F1"-M1" BSP
070-2618-620	87 l/min	20 m	1" - 25x35	F1"-M1" BSP
070-2618-630	85 l/min	30 m	1" - 25x35	F1"-M1" BSP



## OVERALL DIMENSIONS FIXED VERSION

Mod.	A	B	C	D	E	F	G	H			
FX-550	200	150	225	270	120	590	550	600	22,00<45,00	0,130	1
FX-555	250	200	225	270	170	590	550	600	26,00<53,00	0,150	1
FX-560	440	390	225	270	360	590	550	600	33,00<83,00	0,240	1

# SWIVELLING AUTOMATIC HOSE REELS IN AISI 304 STAINLESS STEEL FOR GASOLINE 16 bar

Equipped with:

- Black antistatic synthetic rubber hoses steel wire helix with high strength synthetic textile plies, copper wire
- Reference regulations: EN 1761 - EN 12115 ATEX (EX ZONE)
- Self-extinguishing according to: TRbf 131/2
- Galvanized steel connections
- Stainless steel 90° swivelling joint - Viton® seals
- Compliant with ATEX directive (see ATEX regulation at page 390)

CE  II 2 G Ex h IIB T4 Gb X  
II 2 D Ex h IIIC T4 Db

Article	Capacity	L. hose	Ø hose	Inlet-Outlet
071-2418-600	95 l/min	without hose	-	F1"-M1" BSP
071-2418-510	90 l/min	10 m	3/4"- 19x27	F1"-M1" BSP
071-2418-515	85 l/min	15 m	3/4"- 19x27	F1"-M1" BSP
071-2418-610	95 l/min	10 m	1" - 25x35	F1"-M1" BSP

SX-550



Article	Capacity	L. hose	Ø hose	Inlet-Outlet
071-2518-600	95 l/min	without hose	-	F1"-M1" BSP
071-2518-520	83 l/min	20 m	3/4"- 19x27	F1"-M1" BSP
071-2518-615	90 l/min	15 m	1" - 25x35	F1"-M1" BSP

SX-555



## OVERALL DIMENSIONS SWIVELLING VERSION

Mod.	A	B	C	D	E	F	G	H
SX-550	200	150	225	270	120	572	550	680
SX-555	250	200	225	270	170	572	550	680



									23,00<45,00	0,130	1
									27,00<54,00	0,150	1

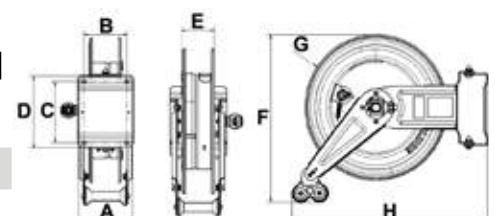

# FIXED AUTOMATIC HOSE REELS IN AISI 304 STAINLESS STEEL FOR FOOD 120 °C 15 bar

Equipped with:

- White EPDM rubber tubes with blue cover
- Regulations: DM 21/3/73 e 18/6/79 + FOOD QUALITY F.D.A.
- AISI 316 stainless steel connections
- AISI 316 stainless steel 90° swivelling joint - EPDM Seals



**FX-400**

Article	L. hose	Ø hose	Max pressure	Inlet-Outlet
070-2213-400	without hose	-	-	F1/2"-M1/2" BSP
070-2213-410	10 m	1/2"	15 bar	F1/2"-M1/2"BSP



**FX-460**

Article	L. hose	Ø hose	Max pressure	Inlet-Outlet
070-2313-400	without hose	-	-	F1/2"-M1/2" BSP
070-2313-415	15 m	1/2"	15 bar	F1/2"-M1/2" BSP



**FX-550**

Article	L. hose	Ø hose	Max pressure	Inlet-Outlet
070-2413-400	without hose	-	-	F1/2"-M1/2" BSP
070-2413-500	without hose	-	-	F1"-M3/4" BSP
070-2413-420	20 m	1/2"	15 bar	F1/2"-M1/2" BSP
070-2413-425	25 m	1/2"	15 bar	F1/2"-M1/2" BSP
070-2413-515	15 m	3/4"	15 bar	F1"-M3/4" BSP





**FX-555**

Article	L. hose	Ø hose	Max pressure	Inlet-Outlet
070-2513-400	without hose	-	-	F1/2"-M1/2" BSP
070-2513-500	without hose	-	-	F1"-M3/4" BSP
070-2513-600	without hose	-	-	F1"-M1" BSP
070-2513-430	30 m	1/2"	15 bar	F1/2"-M1/2" BSP
070-2513-520	20 m	3/4"	15 bar	F1"-M3/4" BSP

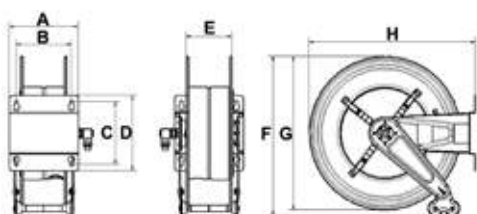
## OVERALL DIMENSIONS FIXED VERSION



Mod.	A	B	C	D	E	F	G	H			
FX-400	158	120	168	192	95	460	400	435	12,50<19,50	0,084	1
FX-460	158	120	168	192	95	490	460	490	16,50<23,00	0,094	1
FX-550	200	150	225	270	120	590	550	600	22,00<45,00	0,130	1
FX-555	250	200	225	270	170	590	550	600	26,00<53,00	0,150	1

# SWIVELLING AUTOMATIC HOSE REELS IN AISI 304 STAINLESS STEEL FOR FOOD 120 ° C 15 bar

Equipped with:

- White EPDM rubber tubes with blue cover
- Regulations: DM 21/3/73 e 18/6/79 + FOOD QUALITY F.D.A.
- AISI 316 stainless steel connections
- AISI 316 stainless steel 90° swivelling joint - EPDM Seals

Article	L. hose	Ø hose	Max pressure	Inlet-Outlet	SX-400
071-2213-400	without hose	-	-	F1/2"-M1/2" BSP	
071-2213-410	10 m	1/2"	15 bar	F1/2"-M1/2" BSP	



Article	L. hose	Ø hose	Max pressure	Inlet-Outlet	SX-460
071-2313-400	without hose	-	-	F1/2"-M1/2" BSP	
071-2313-415	15 m	1/2"	15 bar	F1/2"-M1/2" BSP	





Article	L. hose	Ø hose	Max pressure	Inlet-Outlet	SX-550
071-2413-400	without hose	-	-	F1/2"-M1/2" BSP	
071-2413-500	without hose	-	-	F1"-M3/4" BSP	
071-2413-420	20 m	1/2"	15 bar	F1/2"-M1/2" BSP	
071-2413-425	25 m	1/2"	15 bar	F1/2"-M1/2" BSP	
071-2413-515	15 m	3/4"	15 bar	F1"-M3/4" BSP	



Article	L. hose	Ø hose	Max pressure	Inlet-Outlet	SX-555
071-2513-400	without hose	-	-	F1/2"-M1/2" BSP	
071-2513-500	without hose	-	-	F1"-M3/4" BSP	
071-2513-600	without hose	-	-	F1"-M1" BSP	
071-2513-430	30 m	1/2"	15 bar	F1/2"-M1/2" BSP	
071-2513-520	20 m	3/4"	15 bar	F1"-M3/4" BSP	



## OVERALL DIMENSIONS SWIVELLING VERSION

Mod.	A	B	C	D	E	F	G	H				
SX-400	150	120	168	196	95	460	400	550	13,50	<20,50	0,084	1
SX-460	150	120	168	196	95	490	460	575	17,50	<24,00	0,094	1
SX-550	200	150	225	270	120	572	550	680	23,00	<45,00	0,130	1
SX-555	250	200	225	270	170	572	550	680	27,00	<54,00	0,150	1

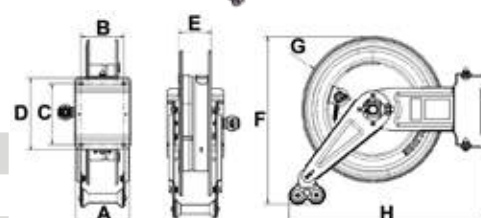

# FIXED AUTOMATIC HOSE REELS IN AISI 304 STAINLESS STEEL WITHOUT HOSE

## FX-400



Article	Fluid dispensed	90° swivelling joint	Seals	Inlet-Outlet
070-2201-300	Air-Water 20 bar	brass	Viton®	F3/8"-M3/8" BSP
070-2201-400	Air-Water 20 bar	brass	Viton®	F1/2"-M1/2" BSP
070-2205-300	Water 150 °C 400 bar	stainless steel	Viton®	F3/8"-M3/8" BSP
070-2205-400	Water 150 °C 400 bar	stainless steel	Viton®	F1/2"-M1/2" BSP
070-2209-400	Antifreeze-Windscreen 20 bar	stainless steel	Viton®	F1/2"-M1/2" BSP
070-2213-400	Food quality F.D.A. 15 bar	stainless steel	EPDM	F1/2"-M1/2" BSP

## FX-460



Article	Fluid dispensed	90° swivelling joint	Seals	Inlet-Outlet
070-2301-400	Air-Water 20 bar	brass	Viton®	F1/2"-M1/2" BSP
070-2305-300	Water 150 °C 400 bar	stainless steel	Viton®	F3/8"-M3/8" BSP
070-2305-400	Water 150 °C 400 bar	stainless steel	Viton®	F1/2"-M1/2" BSP
070-2309-400	Antifreeze-Windscreen 20 bar	stainless steel	Viton®	F1/2"-M1/2" BSP
070-2313-400	Food quality F.D.A. 15 bar	stainless steel	EPDM	F1/2"-M1/2" BSP

## FX-550



Article	Fluid dispensed	90° swivelling joint	Seals	Inlet-Outlet
070-2401-400	Air-Water 20 bar	brass	Viton®	F1/2"-M1/2" BSP
070-2405-300	Water 150 °C 400 bar	stainless steel	Viton®	F3/8"-M3/8" BSP
070-2405-400	Water 150 °C 400 bar	stainless steel	Viton®	F1/2"-M1/2" BSP
070-2408-600	Diesel 10 bar	galvanized steel	Viton®	F1"-M1" BSP
070-2409-500	AdBlue® 20 bar	stainless steel	Viton®	F3/4"-M3/4" BSP
070-2413-400	Food quality F.D.A. 15 bar	stainless steel	EPDM	F1/2"-M1/2" BSP
070-2413-500	Food quality F.D.A. 15 bar	stainless steel	EPDM	F1"-M3/4" BSP
070-2418-600	Gasoline 16 bar	galvanized steel	Viton®	F1"-M1" BSP

## FX-555



Article	Fluid dispensed	90° swivelling joint	Seals	Inlet-Outlet
070-2502-400	Air-Water 20 bar	brass	Viton®	F1/2"-M1/2" BSP
070-2502-600	Air-Water 20 bar	brass	Viton®	F1"-M1" BSP
070-2505-300	Water 150 °C 400 bar	stainless steel	Viton®	F3/8"-M3/8" BSP
070-2505-400	Water 150 °C 400 bar	stainless steel	Viton®	F1/2"-M1/2" BSP
070-2508-600	Diesel 10 bar	galvanized steel	Viton®	F1"-M1" BSP
070-2513-400	Food quality F.D.A. 15 bar	stainless steel	EPDM	F1/2"-M1/2" BSP
070-2513-500	Food quality F.D.A. 15 bar	stainless steel	EPDM	F1"-M3/4" BSP
070-2513-600	Food quality F.D.A. 15 bar	stainless steel	EPDM	F1"-M1" BSP
070-2518-600	Gasoline 16 bar	stainless steel	Viton®	F1"-M1" BSP

## FX-560



Article	Fluid dispensed	90° swivelling joint	Seals	Inlet-Outlet
070-2602-600	Air-Water 20 bar	brass	Viton®	F1"-M1" BSP
070-2605-400	Water 150 °C 400 bar	stainless steel	Viton®	F1/2"-M1/2" BSP
070-2608-600	Diesel 10 bar	galvanized steel	Viton®	F1"-M1" BSP
070-2613-400	Food quality F.D.A. 15 bar	stainless steel	EPDM	F1/2"-M1/2" BSP
070-2613-500	Food quality F.D.A. 15 bar	stainless steel	EPDM	F1"-M3/4" BSP
070-2613-600	Food quality F.D.A. 15 bar	stainless steel	EPDM	F1"-M1" BSP
070-2618-600	Gasoline 16 bar	stainless steel	Viton®	F1"-M1" BSP

### OVERALL DIMENSIONS FIXED VERSION

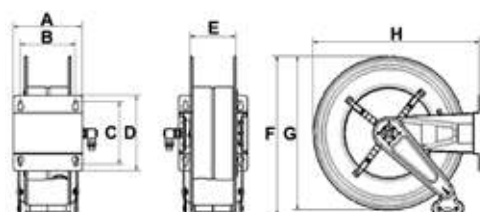



Mod.	A	B	C	D	E	F	G	H	Kg	m <sup>3</sup>	W
FX-400	158	120	168	192	95	460	400	435	12,50	0,084	1
FX-460	158	120	168	192	95	490	460	490	16,50	0,094	1
FX-550	200	150	225	270	120	590	550	600	22,00	0,130	1
FX-555	250	200	225	270	170	590	550	600	26,00	0,150	1
FX-560	440	390	225	270	360	590	550	600	33,00	0,240	1

# SWIVELLING AUTOMATIC HOSE REELS IN AISI 304 STAINLESS STEEL WITHOUT HOSE



Article	Fluid dispensed	90°swivelling joint	Seals	Inlet-Outlet	SX-400
071-2201-300	Air-Water 20 bar	brass	Viton®	F3/8" -M3/8" BSP	
071-2201-400	Air-Water 20 bar	brass	Viton®	F1/2" -M1/2" BSP	
071-2205-300	Water 150°C 400 bar	stainless steel	Viton®	F3/8" -M3/8" BSP	
071-2205-400	Water 150°C 400 bar	stainless steel	Viton®	F1/2" -M1/2" BSP	
071-2209-400	Antifreeze-Windscreen 20 bar	stainless steel	Viton®	F1/2" -M1/2" BSP	
071-2213-400	Food quality F.D.A. 15 bar	stainless steel	EPDM	F1/2" -M1/2" BSP	

Article	Fluid dispensed	90°swivelling joint	Seals	Inlet-Outlet	SX-460
071-2301-400	Air-Water 20 bar	brass	Viton®	F1/2" -M1/2" BSP	
071-2305-300	Water 150°C 400 bar	stainless steel	Viton®	F3/8" -M3/8" BSP	
071-2305-400	Water 150°C 400 bar	stainless steel	Viton®	F1/2" -M1/2" BSP	
071-2309-400	Antifreeze-Windscreen 20 bar	stainless steel	Viton®	F1/2" -M1/2" BSP	
071-2313-400	Food quality F.D.A. 15 bar	stainless steel	EPDM	F1/2" -M1/2" BSP	

Article	Fluid dispensed	90°swivelling joint	Seals	Inlet-Outlet	SX-550
071-2401-400	Air-Water 20 bar	brass	Viton®	F1/2" -M1/2" BSP	
071-2405-300	Water 150°C 400 bar	stainless steel	Viton®	F3/8" -M3/8" BSP	
071-2405-400	Water 150°C 400 bar	stainless steel	Viton®	F1/2" -M1/2" BSP	
071-2408-600	Diesel 10 bar	galvanized steel	Viton®	F1" -M1" BSP	
071-2409-500	AdBlue® 20 bar	stainless steel	Viton®	F3/4" -M3/4" BSP	
071-2413-400	Food quality F.D.A. 15 bar	stainless steel	EPDM	F1/2" -M1/2" BSP	
071-2413-500	Food quality F.D.A. 15 bar	stainless steel	EPDM	F1" -M3/4" BSP	
071-2418-600	Gasoline 16 bar	galvanized steel	Viton®	F1" -M1" BSP	

Article	Fluid dispensed	90°swivelling joint	Seals	Inlet-Outlet	SX-555
071-2502-400	Air-Water 20 bar	brass	Viton®	F1/2" -M1/2" BSP	
071-2502-600	Air-Water 20 bar	brass	Viton®	F1" -M1" BSP	
071-2505-300	Water 150°C 400 bar	stainless steel	Viton®	F3/8" -M3/8" BSP	
071-2505-400	Water 150°C 400 bar	stainless steel	Viton®	F1/2" -M1/2" BSP	
071-2508-600	Diesel 10 bar	galvanized steel	Viton®	F1" -M1" BSP	
071-2513-400	Food quality F.D.A. 15 bar	stainless steel	EPDM	F1/2" -M1/2" BSP	
071-2513-500	Food quality F.D.A. 15 bar	stainless steel	EPDM	F1" -M3/4" BSP	
071-2513-600	Food quality F.D.A. 15 bar	stainless steel	EPDM	F1" -M1" BSP	
071-2518-600	Gasoline 16 bar	stainless steel	Viton®	F1" -M1" BSP	

## OVERALL DIMENSIONS SWIVELLING VERSION

Mod.	A	B	C	D	E	F	G	H			
SX-400	150	120	168	196	95	460	400	550	13,50	0,084	1
SX-460	150	120	168	196	95	490	460	575	17,50	0,094	1
SX-550	200	150	225	270	120	572	550	680	23,00	0,130	1
SX-555	250	200	225	270	170	572	550	680	27,00	0,150	1

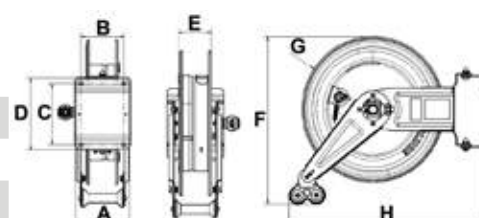

# PLASTIC AUTOMATIC CABLE REELS WITH ELECTRIC CABLE AND SWIVELLING BRACKET

Article	Cable length	Cable type	Power with rolled cable	Power with unrolled cable	Inlet	Outlet	Type of socket
078-3420-310	10 m	3GX1,5 mm <sup>2</sup> H05VV-F	800 W	2000 W	230 V	230 V	Schuko



ES-260

## Automatic cable reel Mod. ES-260 3GX1,5 | 10 m

- Automatic spring rewinding
- Plastic outer casing
- Steel **swivelling wall bracket**
- User can stop the cable at the required length
- CE approved
- TÜV approved

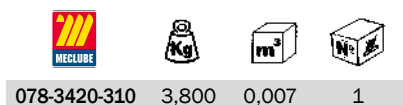

078-3420-310 3,800 0,007 1

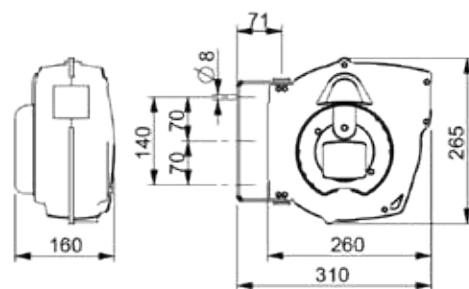

Article	Cable length	Cable type	Power with rolled cable	Power with unrolled cable	Inlet	Outlet	Type of socket
078-3423-315	15 m	3GX1,5 mm <sup>2</sup> H05VV-F	800 W	2000 W	230 V	230 V	Schuko



ES-275

## Automatic cable reel Mod. ES-275 3GX1,5 | 15 m

- Automatic spring rewinding
- Plastic outer casing
- Steel **swivelling wall bracket**
- User can stop the cable at the required length
- CE approved
- TÜV approved

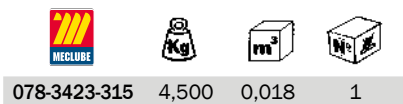

078-3423-315 4,500 0,018 1

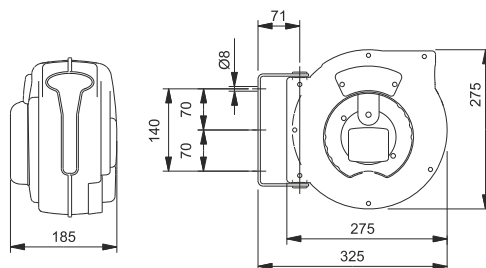

Article	Cable length	Cable type	Power with rolled cable	Power with unrolled cable	Inlet	Outlet	Type of socket
078-3423-410	10 m	3GX2,5 mm <sup>2</sup> H07RN-F	1600 W	3000 W	230 V	230 V	Schuko



ES-275

## Automatic cable reel Mod. ES-275 3GX2,5 | 10 m

- Automatic spring rewinding
- Plastic outer casing
- Steel **swivelling wall bracket**
- User can stop the cable at the required length
- CE approved
- TÜV approved

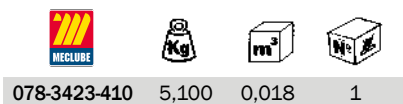

078-3423-410 5,100 0,018 1

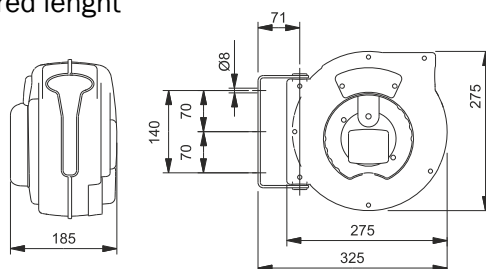





# PLASTIC AUTOMATIC CABLE REELS WITH ELECTRIC CABLE AND SWIVELLING BRACKET AND PORTABLE LAMP

Article	Cable length	Cable type	Inlet voltage	Outlet voltage	LED light	Light power
078-3435-215	15 m	2GX1 mm <sup>2</sup> H05RN-F	12V / 24V~AC	12V / 24V~AC	18 LED	900 lumen

## Automatic cable reel without transformer Mod. ES-260L I 15 m

- Automatic spring rewinding
- Plastic outer casing
- Steel **swivelling wall bracket**
- User can stop the cable at the required length
- **With portable lamp 18 LED**
- CE approved
- TÜV approved

			
078-3435-215	3,900	0,028	1

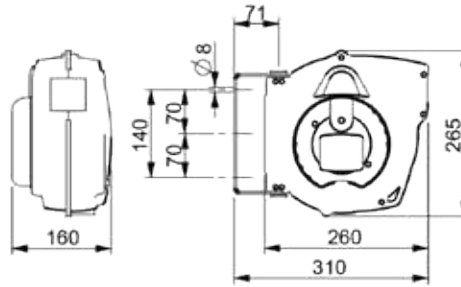



ES-260L

Article	Cable length	Cable type	Inlet voltage	Outlet voltage	LED light	Light power
078-3440-215	15 m	2GX1 mm <sup>2</sup> H05RN-F	230V	da 12V a 24V	18 LED	900 lumen

## Automatic cable reel with transformer Mod. ES-260L I 15 m

- Automatic spring rewinding
- Plastic outer casing
- Steel **swivelling wall bracket**
- User can stop the cable at the required length
- **With portable lamp 18 LED**
- CE approved
- TÜV approved

			
078-3440-215	4,400	0,028	1

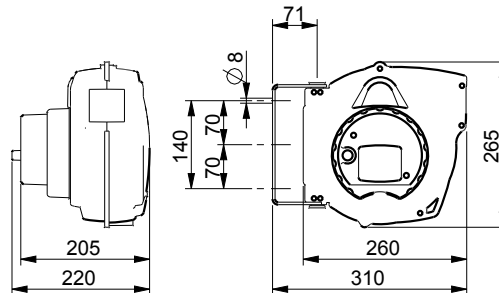





ES-260L

Article	Operating voltage	N° LED	Light power	Protection rating
078-3448-018	12V / 24V~AC	18	900 lumen	IP65

## Portable lamp 18 LED

- Transparent protective cover
- Non-slip handle with switch
- Adjustable hook
- Usage voltage 12 - 24V
- CE approved

			
078-3448-018	0,350	0,002	1

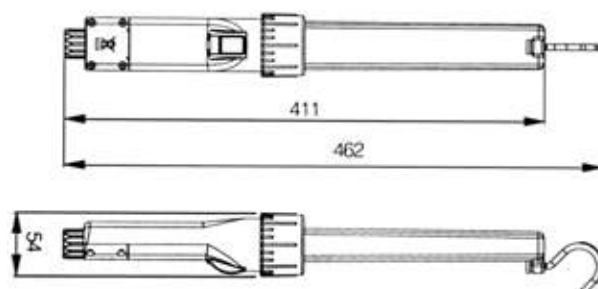

ES-260L

# PLASTIC AUTOMATIC GROUNDING CABLE REELS WITH SWIVELLING BRACKET



**ES-260MT**

Article	Cable length	Type cable	Clamp
078-3450-615	15 m	1X6 mm <sup>2</sup> H07V-K	without caliper

## Automatic grounding cable reel Mod. ES-260MT

- Automatic spring rewinding
- Plastic outer casing
- Steel **swivelling wall bracket**
- User can stop the cable at the required length
- Unipolar yellow/green cable 15m X 6 mm<sup>2</sup>
- CE approved



078-3450-615	2,800	0,015	1
--------------	-------	-------	---

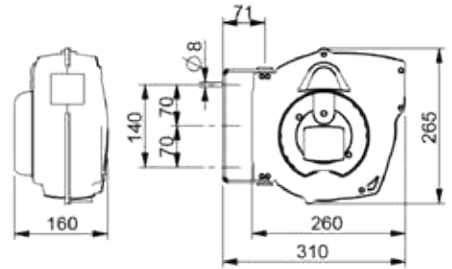

**ES-260PT**

Article	Cable length	Type cable	Clamp
078-3452-615	15 m	1X6 mm <sup>2</sup> H07V-K	Grounding 80 A

## Automatic grounding cable reel Mod. ES-260PT

- Automatic spring rewinding
- Plastic outer casing
- Steel **swivelling wall bracket**
- User can stop the cable at the required length
- Unipolar yellow/green cable 15m X 6 mm<sup>2</sup>
- **Grounding clamp 80 A**
- CE approved



078-3452-615	3,200	0,015	1
--------------	-------	-------	---

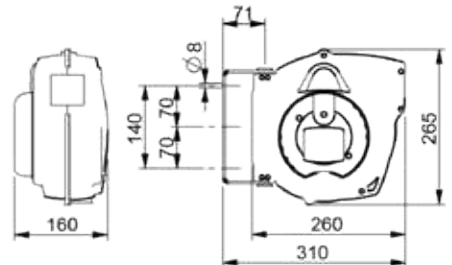

**ES-260PTA**

Article	Cable length	Type cable	Clamp
078-3454-615	15 m	1X6 mm <sup>2</sup> H07V-K	Explosion - proof

## Automatic grounding cable reel Mod. ES-260PTA

- Automatic spring rewinding
- Plastic outer casing
- Steel **swivelling wall bracket**
- User can stop the cable at the required length
- Unipolar yellow/green cable 15m X 6 mm<sup>2</sup>
- **Explosion - proof grounding clamp according to standard directive 94/9CE CESI 03 ATEX 101X** insulation voltage: 3kV - rated current: 10A
- CE approved



078-3454-615	3,800	0,023	1
--------------	-------	-------	---

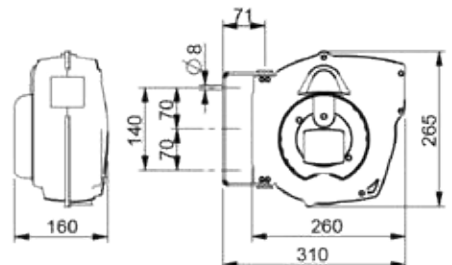





The grounding cable reel is used during the transfer of flammable liquids in order to avoid the accumulation of dangerous electrostatic charges

# PLASTIC AUTOMATIC HOSE REELS FOR AIR FROM 10 TO 20 bar

Article	L. hose	Ø hose	Max pressure	Inlet-Outlet
075-3401-112	12+1 m	6x10	10 bar	F1/4"G - M1/4"G
075-3401-209	9+1 m	8x12	10 bar	F1/4"G - M1/4"G

Equipped with:

- Polyurethane blue hoses 10 bar
- Nickel-plated brass connections
- Swivelling joint 90° nickel-plated brass
- Viton® seals

				
075-3401-112	3,600	0,018	1	
075-3401-209	3,430	0,018	1	

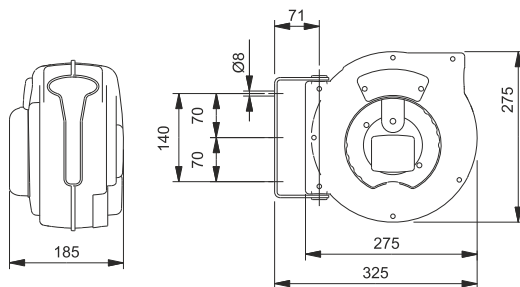





CS-275

Article	L. hose	Ø hose	Max pressure	Inlet-Outlet
075-3601-215	15 m	8x12	15 bar	F1/4"G - M1/4"G
075-3601-315	14+1 m	10x14	15 bar	F3/8"G - M3/8"G

Equipped with:

- Polyurethane blue hoses 15 bar
- Nickel-plated brass connections
- Swivelling joint 90° nickel-plated brass
- Viton® seals

				
075-3601-215	5,170	0,038	1	
075-3601-315	5,620	0,038	1	

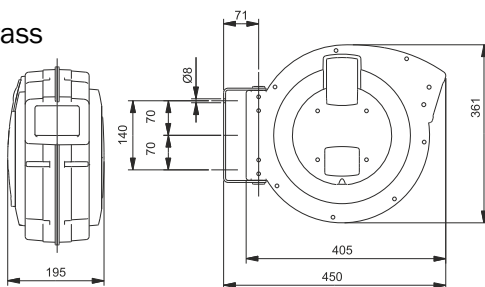

CS-360

## FIXED AND SWIVELLING CLOSED HOSE REELS IN PAINTED STEEL FOR AIR-WATER 20 bar

Equipped with:





- Polyurethane blue hoses 20 bar
- Nickel-plated brass connections
- Swivelling joint 90° nickel-plated brass
- Viton® seals

### FIXED VERSION CF-300

Article	L. hose	Ø hose	Max pressure	Inlet-Outlet
074-4301-211	11+1,5 m	8x12	20 bar	F1/4"G - M1/4"G

### SWIVELLING VERSION CS-300

Article	L. hose	Ø hose	Max pressure	Inlet-Outlet
075-4301-211	11+1,5 m	8x12	20 bar	F1/4"G - M1/4"G

				
074-4301-211	11,700	0,030	1	
075-4301-211	12,440	0,030	1	

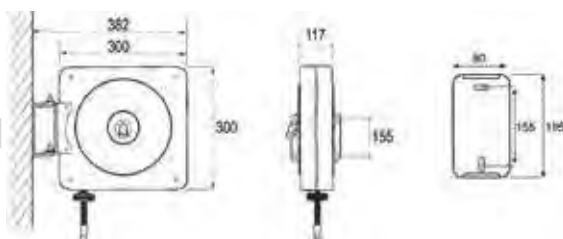

CF-300



CS-300

# FIXED CLOSED HOSE REELS IN PAINTED STEEL

## FOR AIR-WATER 28 bar

Equipped with:

- Black synthetic rubber hoses R6
- Galvanized steel connections
- Brass 90° swivelling joint
- Viton® seals



CF-500	Article	L. hose	Ø hose	Max pressure	Inlet-Outlet
	074-4502-300	without hose	-	-	F1/2"-M3/8" BSP
	074-4502-400	without hose	-	-	F1/2"-M1/2" BSP
	074-4502-212	12 m	5/16"	28 bar	F1/2"-M1/4" BSP
	074-4502-218	18 m	5/16"	28 bar	F1/2"-M1/4" BSP
	074-4502-310	10 m	3/8"	28 bar	F1/2"-M3/8" BSP
	074-4502-318	18 m	3/8"	28 bar	F1/2"-M3/8" BSP
	074-4502-410	10 m	1/2"	28 bar	F1/2"-M1/2" BSP
	074-4502-415	15 m	1/2"	28 bar	F1/2"-M1/2" BSP

## FOR WATER 150° C 200 bar

Equipped with:

- Blue no trace synthetic rubber hoses 1SC
- Galvanized steel connections
- AISI 304 stainless steel 90° swivelling joint
- Teflon seals



CF-500	Article	L. hose	Ø hose	Max pressure	Inlet-Outlet
	074-4505-300	without hose	-	-	F1/2"-M3/8" BSP
	074-4504-210	10 m	5/16"	200 bar	F1/2"-M3/8" BSP
	074-4504-215	15 m	5/16"	200 bar	F1/2"-M3/8" BSP
	074-4504-310	10 m	3/8"	200 bar	F1/2"-F3/8" BSP
	074-4504-315	15 m	3/8"	200 bar	F1/2"-F3/8" BSP
	074-4504-318	18 m	3/8"	200 bar	F1/2"-F3/8" BSP

## FOR WATER 150° C 400 bar

Equipped with:

- Blue no trace synthetic rubber hoses 2SC
- Galvanized steel connections
- AISI 304 stainless steel 90° swivelling joint
- Teflon seals



CF-500	Article	L. hose	Ø hose	Max pressure	Inlet-Outlet
	074-4505-300	without hose	-	-	F1/2"-M3/8" BSP
	074-4505-310	10 m	3/8"	400 bar	F1/2"-F3/8" BSP
	074-4505-315	15 m	3/8"	400 bar	F1/2"-F3/8" BSP
	074-4505-318	18 m	3/8"	400 bar	F1/2"-F3/8" BSP



CF-500 22,900<29,850 0,094 1

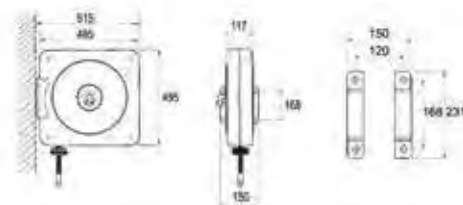

# SWIVELLING CLOSED HOSE REELS IN PAINTED STEEL

## FOR AIR-WATER 28 bar

Equipped with:

- Black synthetic rubber hoses R6
- Galvanized steel connections
- Brass 90° swivelling joint
- Viton® seals

Article	L. hose	Ø hose	Max pressure	Inlet-Outlet
075-4502-300	without hose	-	-	F1/2"-M3/8" BSP
075-4502-400	without hose	-	-	F1/2"-M1/2" BSP
075-4502-212	12 m	5/16"	28 bar	F1/2"-M1/4" BSP
075-4502-218	18 m	5/16"	28 bar	F1/2"-M1/4" BSP
075-4502-310	10 m	3/8"	28 bar	F1/2"-M3/8" BSP
075-4502-318	18 m	3/8"	28 bar	F1/2"-M3/8" BSP
075-4502-410	10 m	1/2"	28 bar	F1/2"-M1/2" BSP
075-4502-415	15 m	1/2"	28 bar	F1/2"-M1/2" BSP

CS-500



## FOR WATER 150 °C 200 bar

Equipped with:

- Blue no trace synthetic rubber hoses 1SC
- Galvanized steel connections
- AISI 304 stainless steel 90° swivelling joint
- Teflon seals

Article	L. hose	Ø hose	Max pressure	Inlet-Outlet
075-4505-300	without hose	-	-	F1/2"-M3/8" BSP
075-4504-210	10 m	5/16"	200 bar	F1/2"-M3/8" BSP
075-4504-215	15 m	5/16"	200 bar	F1/2"-M3/8" BSP
075-4504-310	10 m	3/8"	200 bar	F1/2"-F3/8" BSP
075-4504-315	15 m	3/8"	200 bar	F1/2"-F3/8" BSP
075-4504-318	18 m	3/8"	200 bar	F1/2"-F3/8" BSP

CS-500



## FOR WATER 150 °C 400 bar

Equipped with:

- Blue no trace synthetic rubber hoses 2SC
- Galvanized steel connections
- AISI 304 stainless steel 90° swivelling joint
- Teflon seals

Article	L. hose	Ø hose	Max pressure	Inlet-Outlet
075-4505-300	without hose	-	-	F1/2"-M3/8" BSP
075-4505-310	10 m	3/8"	400 bar	F1/2"-F3/8" BSP
075-4505-315	15 m	3/8"	400 bar	F1/2"-F3/8" BSP
075-4505-318	18 m	3/8"	400 bar	F1/2"-F3/8" BSP

CS-500

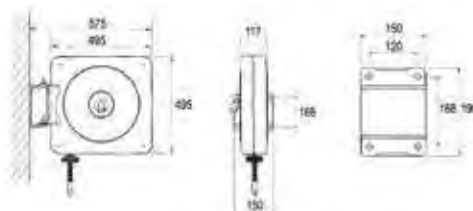

CS-500

23,600<30,550

0,094

1

# FIXED CLOSED HOSE REELS IN PAINTED STEEL

## FOR OIL FROM 160 TO 180 bar

Equipped with:

- Black synthetic rubber hoses 1SC
- Galvanized steel connections
- Galvanized steel 90° swivelling joint
- NBR seals



CF-500	Article	L. hose	Ø hose	Max pressure	Inlet-Outlet
	074-4506-400	without hose	-	-	F1/2"-M1/2" BSP
	074-4506-318	18 m	3/8"	180 bar	F1/2"-M1/2" BSP
	074-4506-410	10 m	1/2"	160 bar	F1/2"-M1/2" BSP
	074-4506-415	15 m	1/2"	160 bar	F1/2"-M1/2" BSP

## FOR GREASE FROM 330 TO 400 bar

Equipped with:

- Black synthetic rubber hoses 2SC
- Galvanized steel connections
- Galvanized steel 90° swivelling joint
- Polyurethane seals



CF-500	Article	L. hose	Ø hose	Max pressure	Inlet-Outlet
	074-4507-200	without hose	-	-	M1/4"-M1/4" BSP
	074-4507-300	without hose	-	-	M3/8"-M3/8" BSP
	074-4507-110	10 m	1/4"	400 bar	M1/4"-M1/4" BSP
	074-4507-115	15 m	1/4"	400 bar	M1/4"-M1/4" BSP
	074-4507-118	18 m	1/4"	400 bar	M1/4"-M1/4" BSP
	074-4507-310	10 m	3/8"	330 bar	M3/8"-M3/8" BSP
	074-4507-315	15 m	3/8"	330 bar	M3/8"-M3/8" BSP

## FOR ANTIFREEZE - WINDSCREEN - AdBlue® 20 bar

Equipped with:

- Black antistatic synthetic rubber EPDM hoses
- AISI 316 stainless steel connections
- AISI 316 stainless steel 90° swivelling joint
- Viton® seals
- Stainless steel reel shaft



CF-500	Article	L. hose	Ø hose	Max pressure	Inlet-Outlet
	074-4509-400	without hose	-	-	F1/2"-M1/2" BSP
	074-4509-410	10 m	1/2"	20 bar	F1/2"-M1/2" BSP
	074-4509-415	15 m	1/2"	20 bar	F1/2"-M1/2" BSP

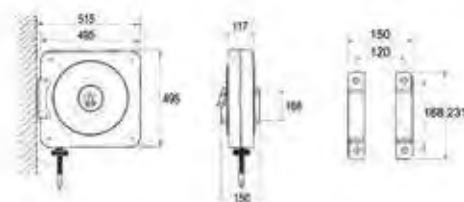

CF-500 22,900-29,850 0,094 1

# SWIVELLING CLOSED HOSE REELS IN PAINTED STEEL

## FOR OIL FROM 160 TO 180 bar

Equipped with:

- Black synthetic rubber hoses 1SC
- Galvanized steel connections
- Galvanized steel 90° swivelling joint
- NBR seals

Article	L. hose	Ø hose	Max pressure	Inlet-Outlet
075-4506-400	without hose	-	-	F1/2"-M1/2" BSP
075-4506-318	18 m	3/8"	180 bar	F1/2"-M1/2" BSP
075-4506-410	10 m	1/2"	160 bar	F1/2"-M1/2" BSP
075-4506-415	15 m	1/2"	160 bar	F1/2"-M1/2" BSP

CS-500



## FOR GREASE FROM 330 TO 400 bar

Equipped with:

- Black synthetic rubber hoses 2SC
- Galvanized steel connections
- Galvanized steel 90° swivelling joint
- Polyurethane seals

Article	L. hose	Ø hose	Max pressure	Inlet-Outlet
075-4507-200	without hose	-	-	M1/4"-M1/4" BSP
075-4507-300	without hose	-	-	M3/8"-M3/8" BSP
075-4507-110	10 m	1/4"	400 bar	M1/4"-M1/4" BSP
075-4507-115	15 m	1/4"	400 bar	M1/4"-M1/4" BSP
075-4507-118	18 m	1/4"	400 bar	M1/4"-M1/4" BSP
075-4507-310	10 m	3/8"	330 bar	M3/8"-M3/8" BSP
075-4507-315	15 m	3/8"	330 bar	M3/8"-M3/8" BSP

CS-500



## FOR ANTIFREEZE - WINDSCREEN - AdBlue® 20 bar

Equipped with:

- Black antistatic synthetic rubber EPDM hoses
- AISI 316 stainless steel connections
- AISI 316 stainless steel 90° swivelling joint
- Viton® seals
- Stainless steel reel shaft

Article	L. hose	Ø hose	Max pressure	Inlet-Outlet
075-4509-400	without hose	-	-	F1/2"-M1/2" BSP
075-4509-410	10 m	1/2"	20 bar	F1/2"-M1/2" BSP
075-4509-415	15 m	1/2"	20 bar	F1/2"-M1/2" BSP

CS-500

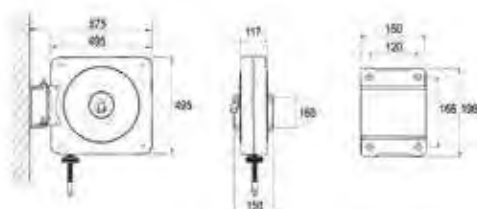

CS-500 23,600<30,550 0,094 1

## FOR AIR-WATER 28 bar

Equipped with:

- Black synthetic rubber hoses R6
- Galvanized steel connections
- Brass 90° swivelling joint
- Viton® seals



**CFX-500**

Article	L. hose	Ø hose	Max pressure	Inlet-Outlet
074-5502-300	without hose	-	-	F1/2"-M3/8" BSP
074-5502-400	without hose	-	-	F1/2"-M1/2" BSP
074-5502-212	12 m	5/16"	28 bar	F1/2"-M1/4" BSP
074-5502-218	18 m	5/16"	28 bar	F1/2"-M1/4" BSP
074-5502-310	10 m	3/8"	28 bar	F1/2"-M3/8" BSP
074-5502-318	18 m	3/8"	28 bar	F1/2"-M3/8" BSP
074-5502-410	10 m	1/2"	28 bar	F1/2"-M1/2" BSP
074-5502-415	15 m	1/2"	28 bar	F1/2"-M1/2" BSP

## FOR WATER 150° C 200 bar

Equipped with:

- Blue no trace synthetic rubber hoses 1SC
- Galvanized steel connections
- AISI 304 stainless steel 90° swivelling joint
- Teflon seals



**CFX-500**

Article	L. hose	Ø hose	Max pressure	Inlet-Outlet
074-5505-300	without hose	-	-	F1/2"-M3/8" BSP
074-5504-210	10 m	5/16"	200 bar	F1/2"-M3/8" BSP
074-5504-215	15 m	5/16"	200 bar	F1/2"-M3/8" BSP
074-5504-310	10 m	3/8"	200 bar	F1/2"-F3/8" BSP
074-5504-315	15 m	3/8"	200 bar	F1/2"-F3/8" BSP
074-5504-318	18 m	3/8"	200 bar	F1/2"-F3/8" BSP

## FOR WATER 150° C 400 bar

Equipped with:

- Blue no trace synthetic rubber hoses 2SC
- Galvanized steel connections
- AISI 304 stainless steel 90° swivelling joint
- Teflon seals



**CFX-500**

Article	L. hose	Ø hose	Max pressure	Inlet-Outlet
074-5505-300	without hose	-	-	F1/2"-M3/8" BSP
074-5505-310	10 m	3/8"	400 bar	F1/2"-F3/8" BSP
074-5505-315	15 m	3/8"	400 bar	F1/2"-F3/8" BSP
074-5505-318	18 m	3/8"	400 bar	F1/2"-F3/8" BSP



CFX-500 22,900<29,850 0,094 1

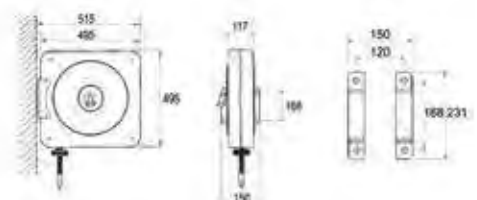

# SWIVELLING CLOSED HOSE REELS IN AISI 304 STAINLESS STEEL

## FOR AIR-WATER 28 bar

Equipped with:

- Black synthetic rubber hoses R6
- Galvanized steel connections
- Brass 90° swivelling joint
- Viton® seals

Article	L. hose	Ø hose	Max pressure	Inlet-Outlet
075-5502-300	without hose	-	-	F1/2"-M3/8" BSP
075-5502-400	without hose	-	-	F1/2"-M1/2" BSP
075-5502-212	12 m	5/16"	28 bar	F1/2"-M1/4" BSP
075-5502-218	18 m	5/16"	28 bar	F1/2"-M1/4" BSP
075-5502-310	10 m	3/8"	28 bar	F1/2"-M3/8" BSP
075-5502-318	18 m	3/8"	28 bar	F1/2"-M3/8" BSP
075-5502-410	10 m	1/2"	28 bar	F1/2"-M1/2" BSP
075-5502-415	15 m	1/2"	28 bar	F1/2"-M1/2" BSP

CSX-500



## FOR WATER 150 °C 200 bar

Equipped with:

- Blue no trace synthetic rubber hoses 1SC
- Galvanized steel connections
- AISI 304 stainless steel 90° swivelling joint
- Teflon seals

Article	L. hose	Ø hose	Max pressure	Inlet-Outlet
075-5505-300	without hose	-	-	F1/2"-M3/8" BSP
075-5504-210	10 m	5/16"	200 bar	F1/2"-M3/8" BSP
075-5504-215	15 m	5/16"	200 bar	F1/2"-M3/8" BSP
075-5504-310	10 m	3/8"	200 bar	F1/2"-F3/8" BSP
075-5504-315	15 m	3/8"	200 bar	F1/2"-F3/8" BSP
075-5504-318	18 m	3/8"	200 bar	F1/2"-F3/8" BSP

CSX-500



## FOR WATER 150 °C 400 bar

Equipped with:

- Blue no trace synthetic rubber hoses 2SC
- Galvanized steel connections
- AISI 304 stainless steel 90° swivelling joint
- Teflon seals

Article	L. hose	Ø hose	Max pressure	Inlet-Outlet
075-5505-300	without hose	-	-	F1/2"-M3/8" BSP
075-5505-310	10 m	3/8"	400 bar	F1/2"-F3/8" BSP
075-5505-315	15 m	3/8"	400 bar	F1/2"-F3/8" BSP
075-5505-318	18 m	3/8"	400 bar	F1/2"-F3/8" BSP

CSX-500

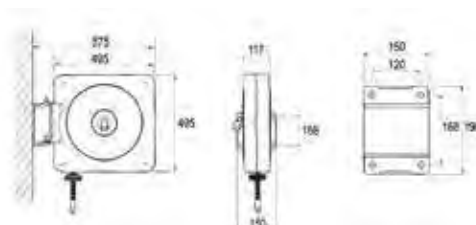

CSX-500 23,600<30,550 0,094 1



# FIXED MANUAL HOSE REELS IN PAINTED STEEL AND AISI 304 STAINLESS STEEL

These fixed manual hose reels, in painted steel and AISI 304 stainless steel, are suitable for flexible hoses for the delivery of compressed air, water, oil and similar fluids, grease, diesel, antifreeze, windscreen, AdBlue®.

They are equipped with a practical revolving flick folding handgrip, the hose winding is fast and safe. They allow to have a workplace which gives the possibility to work in a tidy way. You always have a ready-to-use equipment that ensures to work safely.



# FIXED MANUAL HOSE REELS IN PAINTED STEEL FOR AIR-WATER HOSES FROM 20 TO 28 bar

Equipped with:

- Galvanized steel connections
- Brass 90° swivelling joint
- Viton® seals
- Revolving flick folding handgrip



**FM-400**

Article	Equipped	Hose reel capacity	Inlet-Outlet
077-1201-300	without hose	Ø 3/8" - max 15 m	F1/2"-M3/8" BSP
077-1201-400	without hose	Ø 1/2" - max 10 m	F1/2"-M1/2" BSP



**FM-460**

Article	Equipped	Hose reel capacity	Inlet-Outlet
077-1301-300	without hose	Ø 3/8" - max 18 m	F1/2"-M3/8" BSP
077-1301-400	without hose	Ø 1/2" - max 15 m	F1/2"-M1/2" BSP



**FM-550**

Article	Equipped	Hose reel capacity	Inlet-Outlet
077-1401-400	without hose	Ø 1/2" - max 25 m	F1/2"-M1/2" BSP
077-1402-500	without hose	Ø 3/4" - max 15 m	F1"-M3/4" BSP



**FM-555**



Article	Equipped	Hose reel capacity	Inlet-Outlet
077-1502-400	without hose	Ø 1/2" - max 30 m	F1/2"-M1/2" BSP
077-1502-500	without hose	Ø 3/4" - max 20 m	F1"-M3/4" BSP
077-1502-600	without hose	Ø 1" - max 15 m	F1"-M1" BSP



**FM-560**

Article	Equipped	Hose reel capacity	Inlet-Outlet
077-1602-400	without hose	Ø 1/2" - max 50 m	F1/2"-M1/2" BSP
077-1602-500	without hose	Ø 3/4" - max 40 m	F1"-M3/4" BSP
077-1602-600	without hose	Ø 1" - max 30 m	F1"-M1" BSP

## OVERALL DIMENSIONS

Mod.	A	B	C	D	E	F	G			
FM-400	158	120	168	192	95	400	435	9,85<9,85	0,084	1
FM-460	158	120	168	192	95	460	500	11,31<11,34	0,094	1
FM-550	200	150	225	270	120	550	600	16,21<16,83	0,130	1
FM-555	250	200	225	270	170	550	600	17,77<17,83	0,150	1
FM-560	440	390	225	270	360	550	600	25,75<26,38	0,240	1

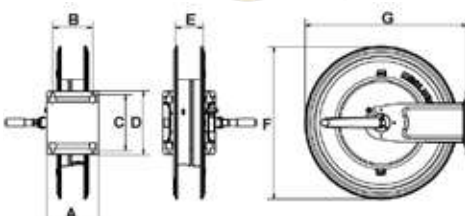



# FIXED MANUAL HOSE REELS IN PAINTED STEEL FOR WATER HOSES 150 °C FROM 200 TO 400 bar

Equipped with:

- Galvanized steel connections
- **AISI 304 stainless steel** 90° swivelling joint
- Viton® seals
- Revolving flick folding handgrip

Article	Equipped	Hose reel capacity	Inlet-Outlet	FM-400
077-1205-300	without hose	Ø 3/8" - max 15 m	F1/2"-M3/8" BSP	
077-1205-400	without hose	Ø 1/2" - max 10 m	F1/2"-M1/2" BSP	



Article	Equipped	Hose reel capacity	Inlet-Outlet	FM-460
077-1305-300	without hose	Ø 3/8" - max 18 m	F1/2"-M3/8" BSP	
077-1305-400	without hose	Ø 1/2" - max 15 m	F1/2"-M1/2" BSP	

Article	Equipped	Hose reel capacity	Inlet-Outlet	FM-550
077-1405-400	without hose	Ø 1/2" - max 25 m	F1/2"-M1/2" BSP	
077-1405-500	without hose	Ø 3/4" - max 15 m	F1"-M3/4" BSP	

Article	Equipped	Hose reel capacity	Inlet-Outlet	FM-555
077-1505-400	without hose	Ø 1/2" - max 30 m	F1/2"-M1/2" BSP	
077-1505-500	without hose	Ø 3/4" - max 20 m	F1"-M3/4" BSP	
077-1505-600	without hose	Ø 1" - max 15 m	F1"-M1" BSP	

Article	Equipped	Hose reel capacity	Inlet-Outlet	FM-560
077-1605-400	without hose	Ø 1/2" - max 50 m	F1/2"-M1/2" BSP	
077-1605-500	without hose	Ø 3/4" - max 40 m	F1"-M3/4" BSP	
077-1605-600	without hose	Ø 1" - max 30 m	F1"-M1" BSP	

## OVERALL DIMENSIONS

Mod.	A	B	C	D	E	F	G			
FM-400	158	120	168	192	95	400	435	9,85<9,85	0,084	1
FM-460	158	120	168	192	95	460	500	11,31<11,34	0,094	1
FM-550	200	150	225	270	120	550	600	16,21<16,83	0,130	1
FM-555	250	200	225	270	170	550	600	17,77<17,83	0,150	1
FM-560	440	390	225	270	360	550	600	25,75<26,38	0,240	1

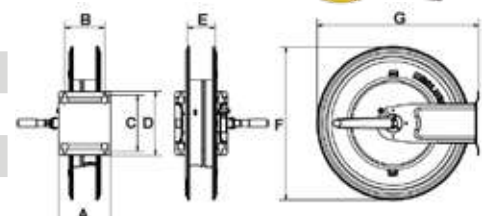

# FIXED MANUAL HOSE REELS IN PAINTED STEEL FOR OIL AND SIMILAR HOSES FROM 88 TO 180 bar

Equipped with:

- Galvanized steel connections
- Galvanized steel 90° swivelling joint
- Polyurethane seals
- Revolving flick folding handgrip



FM-400

Article	Equipped	Hose reel capacity	Inlet-Outlet
077-1206-300	without hose	Ø 3/8" - max 15 m	F1/2"-M3/8" BSP
077-1206-400	without hose	Ø 1/2" - max 10 m	F1/2"-M1/2" BSP



FM-460

Article	Equipped	Hose reel capacity	Inlet-Outlet
077-1306-300	without hose	Ø 3/8" - max 18 m	F1/2"-M3/8" BSP
077-1306-400	without hose	Ø 1/2" - max 15 m	F1/2"-M1/2" BSP



FM-550

Article	Equipped	Hose reel capacity	Inlet-Outlet
077-1406-400	without hose	Ø 1/2" - max 25 m	F1/2"-M1/2" BSP
077-1406-500	without hose	Ø 3/4" - max 15 m	F1"-M3/4" BSP



FM-555



Article	Equipped	Hose reel capacity	Inlet-Outlet
077-1506-400	without hose	Ø 1/2" - max 30 m	F1/2"-M1/2" BSP
077-1506-500	without hose	Ø 3/4" - max 20 m	F1"-M3/4" BSP
077-1506-600	without hose	Ø 1" - max 15 m	F1"-M1" BSP



FM-560

Article	Equipped	Hose reel capacity	Inlet-Outlet
077-1606-400	without hose	Ø 1/2" - max 50 m	F1/2"-M1/2" BSP
077-1606-500	without hose	Ø 3/4" - max 40 m	F1"-M3/4" BSP
077-1606-600	without hose	Ø 1" - max 30 m	F1"-M1" BSP

## OVERALL DIMENSIONS

Mod.	A	B	C	D	E	F	G			
FM-400	158	120	168	192	95	400	435	9,85<9,85	0,084	1
FM-460	158	120	168	192	95	460	500	11,31<11,34	0,094	1
FM-550	200	150	225	270	120	550	600	16,21<16,83	0,130	1
FM-555	250	200	225	270	170	550	600	17,77<17,83	0,150	1
FM-560	440	390	225	270	360	550	600	25,75<26,38	0,240	1

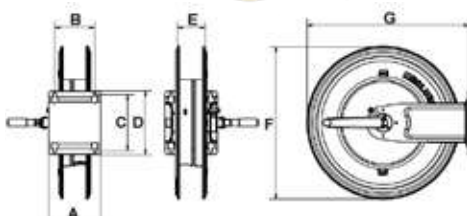



# FIXED MANUAL HOSE REELS IN PAINTED STEEL FOR GREASE HOSES FROM 275 TO 400 bar

Equipped with:

- Galvanized steel connections
- Galvanized steel 90° swivelling joint
- Polyurethane seals
- Revolving flick folding handgrip



Article	Equipped	Hose reel capacity	Inlet-Outlet	FM-400
077-1207-200	without hose	Ø 1/4" - max 15 m	M1/4"-M1/4" BSP	
077-1207-300	without hose	Ø 3/8" - max 10 m	M3/8"-M3/8" BSP	
077-1207-400	without hose	Ø 1/2" - max 10 m	M1/2"-M1/2" BSP	

Article	Equipped	Hose reel capacity	Inlet-Outlet	FM-460
077-1307-200	without hose	Ø 1/4" - max 18 m	M1/4"-M1/4" BSP	
077-1307-300	without hose	Ø 3/8" - max 15 m	M3/8"-M3/8" BSP	
077-1307-400	without hose	Ø 1/2" - max 15 m	M1/2"-M1/2" BSP	

Article	Equipped	Hose reel capacity	Inlet-Outlet	FM-550
077-1407-300	without hose	Ø 3/8" - max 25 m	M3/8"-M3/8" BSP	
077-1407-400	without hose	Ø 1/2" - max 25 m	M1/2"-M1/2" BSP	

Article	Equipped	Hose reel capacity	Inlet-Outlet	FM-555
077-1507-300	without hose	Ø 3/8" - max 30 m	M3/8"-M3/8" BSP	
077-1507-400	without hose	Ø 1/2" - max 30 m	M1/2"-M1/2" BSP	

## OVERALL DIMENSIONS

Mod.	A	B	C	D	E	F	G			
FM-400	158	120	168	192	95	400	435	9,85<9,85	0,084	1
FM-460	158	120	168	192	95	460	500	11,31<11,34	0,094	1
FM-550	200	150	225	270	120	550	600	16,21<16,83	0,130	1
FM-555	250	200	225	270	170	550	600	17,77<17,83	0,150	1

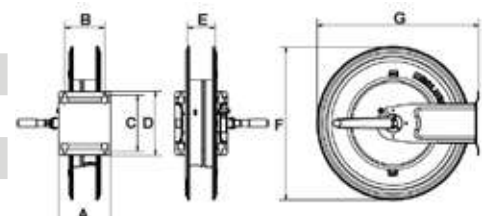

# FIXED MANUAL HOSE REELS IN PAINTED STEEL FOR DIESEL HOSES 10 bar

Equipped with:

- Galvanized steel connections
- Galvanized steel - anodized aluminium 90° swivelling joint
- Viton® seals
- Revolving flick folding handgrip



**FM-460**

Article	Equipped	Hose reel capacity	Inlet-Outlet
077-1308-500	without hose	Ø 3/4" - max 8 m	F1"-M3/4"BSP



**FM-550**

Article	Equipped	Hose reel capacity	Inlet-Outlet
077-1408-600	without hose	Ø 3/4" - max 15 m	F1"-M1" BSP
077-1408-600	without hose	Ø 1" - max 10 m	F1"-M1" BSP



**FM-555**



Article	Equipped	Hose reel capacity	Inlet-Outlet
077-1508-600	without hose	Ø 3/4" - max 20 m	F1"-M1" BSP
077-1508-600	without hose	Ø 1" - max 15 m	F1"-M1" BSP



**FM-560**

Article	Equipped	Hose reel capacity	Inlet-Outlet
077-1608-600	without hose	Ø 3/4" - max 40 m	F1"-M1" BSP
077-1608-600	without hose	Ø 1" - max 30 m	F1"-M1" BSP

## OVERALL DIMENSIONS

Mod.	A	B	C	D	E	F	G			
FM-460	158	120	168	192	95	460	500	11,00<11,00	0,084	1
FM-550	200	150	225	270	120	550	600	15,90<15,90	0,094	1
FM-555	250	200	225	270	170	550	600	17,32<17,32	0,130	1
FM-560	440	390	225	270	360	550	600	25,90<25,90	0,150	1

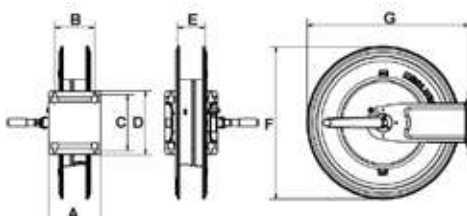



# FIXED MANUAL HOSE REELS IN AISI 304 STAINLESS STEEL FOR AIR-WATER HOSES FROM 20 TO 28 bar

Equipped with:

- AISI 316 stainless steel connections
- Brass 90° swivelling joint
- Viton® seals
- AISI 304 stainless steel revolving flick folding handgrip

Article	Equipped	Hose reel capacity	Inlet-Outlet	FMX-400
077-2201-300	without hose	Ø 3/8" - max 15 m	F1/2"-M3/8" BSP	
077-2201-400	without hose	Ø 1/2" - max 10 m	F1/2"-M1/2" BSP	

Article	Equipped	Hose reel capacity	Inlet-Outlet	FMX-460
077-2301-300	without hose	Ø 3/8" - max 18 m	F1/2"-M3/8" BSP	
077-2301-400	without hose	Ø 1/2" - max 15 m	F1/2"-M1/2" BSP	

Article	Equipped	Hose reel capacity	Inlet-Outlet	FMX-550
077-2401-400	without hose	Ø 1/2" - max 25 m	F1/2"-M1/2" BSP	
077-2402-500	without hose	Ø 3/4" - max 15 m	F1"-M3/4" BSP	

Article	Equipped	Hose reel capacity	Inlet-Outlet	FMX-555
077-2502-400	without hose	Ø 1/2" - max 30 m	F1/2"-M1/2" BSP	
077-2502-500	without hose	Ø 3/4" - max 20 m	F1"-M3/4" BSP	
077-2502-600	without hose	Ø 1" - max 15 m	F1"-M1" BSP	

Article	Equipped	Hose reel capacity	Inlet-Outlet	FMX-560
077-2602-400	without hose	Ø 1/2" - max 50 m	F1/2"-M1/2" BSP	
077-2602-500	without hose	Ø 3/4" - max 40 m	F1"-M3/4" BSP	
077-2602-600	without hose	Ø 1" - max 30 m	F1"-M1" BSP	

## OVERALL DIMENSIONS

Mod.	A	B	C	D	E	F	G			
FMX-400	158	120	168	192	95	400	435	8,85<8,85	0,084	1
FMX-460	158	120	168	192	95	460	500	10,71<10,80	0,094	1
FMX-550	200	150	225	270	120	550	600	15,96<16,33	0,130	1
FMX-555	250	200	225	270	170	550	600	17,22<17,83	0,150	1
FMX-560	440	390	225	270	360	550	600	25,75<26,38	0,240	1

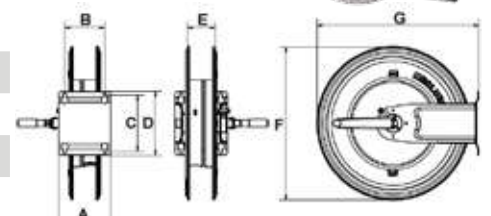

# FIXED MANUAL HOSE REELS IN AISI 304 STAINLESS STEEL FOR WATER HOSES 150 °C FROM 200 TO 400 bar

Equipped with:

- AISI 316 stainless steel connections
- AISI 304 stainless steel 90° swivelling joint
- Viton® seals
- AISI 304 stainless steel revolving flick folding handgrip



**FMX-400**

Article	Equipped	Hose reel capacity	Inlet-Outlet
077-2205-300	without hose	Ø 3/8" - max 15 m	F1/2"-M3/8" BSP
077-2205-400	without hose	Ø 1/2" - max 10 m	F1/2"-M1/2" BSP



**FMX-460**

Article	Equipped	Hose reel capacity	Inlet-Outlet
077-2305-300	without hose	Ø 3/8" - max 18 m	F1/2"-M3/8" BSP
077-2305-400	without hose	Ø 1/2" - max 15 m	F1/2"-M1/2" BSP



**FMX-550**

Article	Equipped	Hose reel capacity	Inlet-Outlet
077-2405-400	without hose	Ø 1/2" - max 25 m	F1/2"-M1/2" BSP
077-2405-500	without hose	Ø 3/4" - max 15 m	F1"-M3/4" BSP



**FMX-555**



Article	Equipped	Hose reel capacity	Inlet-Outlet
077-2505-400	without hose	Ø 1/2" - max 30 m	F1/2"-M1/2" BSP
077-2505-500	without hose	Ø 3/4" - max 20 m	F1"-M3/4" BSP
077-2505-600	without hose	Ø 1" - max 15 m	F1"-M1" BSP



**FMX-560**

Article	Equipped	Hose reel capacity	Inlet-Outlet
077-2605-400	without hose	Ø 1/2" - max 50 m	F1/2"-M1/2" BSP
077-2605-500	without hose	Ø 3/4" - max 40 m	F1"-M3/4" BSP
077-2605-600	without hose	Ø 1" - max 30 m	F1"-M1" BSP

## OVERALL DIMENSIONS

Mod.	A	B	C	D	E	F	G	 Kg	 m³	 Kg
FMX-400	158	120	168	192	95	400	435	8,85<8,85	0,084	1
FMX-460	158	120	168	192	95	460	500	10,71<10,80	0,094	1
FMX-550	200	150	225	270	120	550	600	15,96<16,33	0,130	1
FMX-555	250	200	225	270	170	550	600	17,22<17,83	0,150	1
FMX-560	440	390	225	270	360	550	600	25,75<26,38	0,240	1

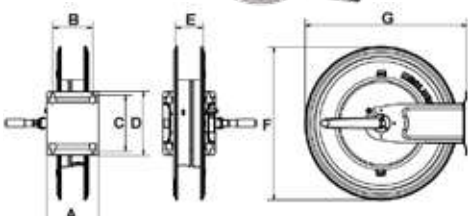



# FIXED MANUAL HOSE REELS IN AISI 304 STAINLESS STEEL FOR OIL AND SIMILAR HOSES FROM 88 TO 180 bar

Equipped with:

- AISI 316 stainless steel connections
- Galvanized steel 90° swivelling joint
- NBR seals
- AISI 304 stainless steel revolving flick folding handgrip

Article	Equipped	Hose reel capacity	Inlet-Outlet	FMX-400
077-2206-300	without hose	Ø 3/8" - max 15 m	F1/2"-M3/8" BSP	
077-2206-400	without hose	Ø 1/2" - max 10 m	F1/2"-M1/2" BSP	

Article	Equipped	Hose reel capacity	Inlet-Outlet	FMX-460
077-2306-300	without hose	Ø 3/8" - max 18 m	F1/2"-M3/8" BSP	
077-2306-400	without hose	Ø 1/2" - max 15 m	F1/2"-M1/2" BSP	

Article	Equipped	Hose reel capacity	Inlet-Outlet	FMX-550
077-2406-400	without hose	Ø 1/2" - max 25 m	F1/2"-M1/2" BSP	
077-2406-500	without hose	Ø 3/4" - max 15 m	F1"-M3/4" BSP	

Article	Equipped	Hose reel capacity	Inlet-Outlet	FMX-555
077-2506-400	without hose	Ø 1/2" - max 30 m	F1/2"-M1/2" BSP	
077-2506-500	without hose	Ø 3/4" - max 20 m	F1"-M3/4" BSP	
077-2506-600	without hose	Ø 1" - max 15 m	F1"-M1" BSP	

Article	Equipped	Hose reel capacity	Inlet-Outlet	FMX-560
077-2606-400	without hose	Ø 1/2" - max 50 m	F1/2"-M1/2" BSP	
077-2606-500	without hose	Ø 3/4" - max 40 m	F1"-M3/4" BSP	
077-2606-600	without hose	Ø 1" - max 30 m	F1"-M1" BSP	

## OVERALL DIMENSIONS

Mod.	A	B	C	D	E	F	G			
FMX-400	158	120	168	192	95	400	435	8,85<8,85	0,084	1
FMX-460	158	120	168	192	95	460	500	10,71<10,80	0,094	1
FMX-550	200	150	225	270	120	550	600	15,96<16,33	0,130	1
FMX-555	250	200	225	270	170	550	600	17,22<17,83	0,150	1
FMX-560	440	390	225	270	360	550	600	25,75<26,38	0,240	1

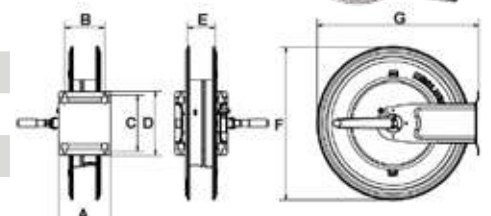

# FIXED MANUAL HOSE REELS IN AISI 304 STAINLESS STEEL FOR GREASE FROM 275 TO 400 bar

Equipped with:

- AISI 316 stainless steel connections
- Galvanized steel 90° swivelling joint
- Polyurethane seals
- AISI 304 stainless steel revolving flick folding handgrip



**FMX-400**

Article	Equipped	Hose reel capacity	Inlet-Outlet
077-2207-200	without hose	Ø 1/4" - max 15 m	M1/4"-M1/4" BSP
077-2207-300	without hose	Ø 3/8" - max 10 m	M3/8"-M3/8" BSP
077-2207-400	without hose	Ø 1/2" - max 10 m	M1/2"-M1/2" BSP



**FMX-460**

Article	Equipped	Hose reel capacity	Inlet-Outlet
077-2307-200	without hose	Ø 1/4" - max 18 m	M1/4"-M1/4" BSP
077-2307-300	without hose	Ø 3/8" - max 15 m	M3/8"-M3/8" BSP
077-2307-400	without hose	Ø 1/2" - max 15 m	M1/2"-M1/2" BSP



**FMX-550**



Article	Equipped	Hose reel capacity	Inlet-Outlet
077-2407-300	without hose	Ø 3/8" - max 25 m	M3/8"-M3/8" BSP
077-2407-400	without hose	Ø 1/2" - max 25 m	M1/2"-M1/2" BSP



**FMX-555**

Article	Equipped	Hose reel capacity	Inlet-Outlet
077-2507-300	without hose	Ø 3/8" - max 30 m	M3/8"-M3/8" BSP
077-2507-400	without hose	Ø 1/2" - max 30 m	M1/2"-M1/2" BSP

## OVERALL DIMENSIONS

Mod.	A	B	C	D	E	F	G			
FMX-400	158	120	168	192	95	400	435	8,85<8,85	0,084	1
FMX-460	158	120	168	192	95	460	500	10,71<10,80	0,094	1
FMX-550	200	150	225	270	120	550	600	15,96<16,33	0,130	1
FMX-555	250	200	225	270	170	550	600	17,22<17,83	0,150	1

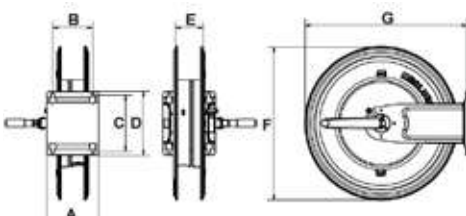

# FIXED MANUAL HOSE REELS IN AISI 304 STAINLESS STEEL FOR DIESEL 10 bar

Equipped with:

- AISI 316 stainless steel connections
- Galvanized steel - anodized aluminium 90° swivelling joint
- Viton® seals
- AISI 304 stainless steel revolving flick folding handgrip

Article	Equipped	Hose reel capacity	Inlet-Outlet	FMX-460
077-2308-500	without hose	Ø 3/4" - max 8 m	F1"-M3/4" BSP	



Article	Equipped	Hose reel capacity	Inlet-Outlet	FMX-550
077-2408-600	without hose	Ø 3/4" - max 15 m	F1"-M1" BSP	
077-2408-600	without hose	Ø 1" - max 10 m	F1"-M1" BSP	



Article	Equipped	Hose reel capacity	Inlet-Outlet	FMX-555
077-2508-600	without hose	Ø 3/4" - max 20 m	F1"-M1" BSP	
077-2508-600	without hose	Ø 1" - max 15 m	F1"-M1" BSP	



Article	Equipped	Hose reel capacity	Inlet-Outlet	FMX-560
077-2608-600	without hose	Ø 3/4" - max 40 m	F1"-M1" BSP	
077-2608-600	without hose	Ø 1" - max 30 m	F1"-M1" BSP	



## OVERALL DIMENSIONS

Mod.	A	B	C	D	E	F	G			
FMX-460	158	120	168	192	95	460	500	10,71<10,80	0,094	1
FMX-550	200	150	225	270	120	550	600	15,96<16,33	0,130	1
FMX-555	250	200	225	270	170	550	600	17,22<17,83	0,150	1
FMX-560	440	390	225	270	360	550	600	25,75<26,38	0,240	1

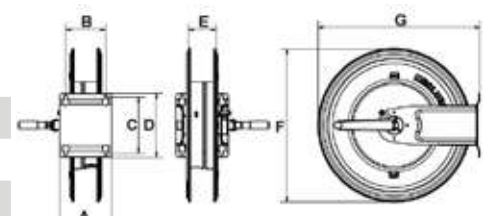

# FIXED MANUAL HOSE REELS IN AISI 304 STAINLESS STEEL FOR ANTIFREEZE - WINDSCREEN - AdBlue® 20 bar

Equipped with:

- AISI 316 stainless steel connections
- AISI 304 stainless steel 90° swivelling joint
- Viton® seals
- AISI 304 stainless steel revolving flick folding handgrip



**FMX-400**

Article	Equipped	Hose reel capacity	Inlet-Outlet
077-2209-400	without hose	Ø 1/2" - max 10 m	F1/2"-M1/2" BSP



**FMX-460**

Article	Equipped	Hose reel capacity	Inlet-Outlet
077-2309-400	without hose	Ø 1/2" - max 15 m	F1/2"-M1/2" BSP



**FMX-550**

Article	Equipped	Hose reel capacity	Inlet-Outlet
077-2409-400	without hose	Ø 1/2" - max 25 m	F1/2"-M1/2" BSP
077-2409-500	without hose	Ø 3/4" - max 15 m	F1"G-M3/4" BSP



**FMX-555**



Article	Equipped	Hose reel capacity	Inlet-Outlet
077-2509-400	without hose	Ø 1/2" - max 30 m	F1/2"-M1/2" BSP
077-2509-500	without hose	Ø 3/4" - max 20 m	F1"-M3/4" BSP



**FMX-560**

Article	Equipped	Hose reel capacity	Inlet-Outlet
077-2609-400	without hose	Ø 1/2" - max 50 m	F1/2"-M1/2" BSP
077-2609-500	without hose	Ø 3/4" - max 40 m	F1"-M3/4" BSP

## OVERALL DIMENSIONS

Mod.	A	B	C	D	E	F	G			
FMX-400	158	120	168	192	95	400	435	8,85<8,85	0,084	1
FMX-460	158	120	168	192	95	460	500	10,71<1w,80	0,094	1
FMX-550	200	150	225	270	120	550	600	15,96<16,33	0,130	1
FMX-555	250	200	225	270	170	550	600	17,22<17,83	0,150	1
FMX-560	440	390	225	270	360	550	600	25,75<26,38	0,240	1

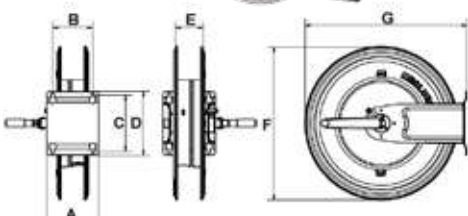

# AUTOMATIC HOSE REELS IN PAINTED STEEL SERIES HEAVY - DUTY

New series of automatic auto-retractable hose reels in painted steel and AISI 304 stainless steel. This new HEAVY-DUTY model is suitable for flexible hoses for the distribution of compressed air, water, oil and similar fluids, grease, gasoline, anti-freeze, windscreen and AdBlue®. They allow to work safely and to quickly unroll only the required hose length, improving the functionality. They are designed for applications which require solid equipment, also on vehicles. **They can have two different hose output positions: superior and inferior.**



# AUTOMATIC HOSE REELS IN PAINTED STEEL SERIES HEAVY - DUTY FOR AIR-WATER FROM 20 TO 28 bar



Equipped with:

- Black synthetic rubber hoses R6
- Galvanized steel connections
- Brass 90° swivelling joint
- Viton® seals

HD-460	Article	L. hose	Ø hose	Max pressure	Inlet-Outlet
	073-1302-400	without hose	-	-	F1/2"-M1/2"BSP
	073-1302-415	15 m	1/2"	28 bar	F1/2"-M1/2" BSP
	073-1302-418	18 m	1/2"	28 bar	F1/2"-M1/2" BSP



HD-550	Article	L. hose	Ø hose	Max pressure	Inlet-Outlet
	073-1402-400	without hose	-	-	F1/2"-M1/2" BSP
	073-1402-500	without hose	-	-	F1"-M3/4" BSP
	073-1402-420	20 m	1/2"	28 bar	F1/2"-M1/2" BSP
	073-1402-425	25 m	1/2"	28 bar	F1/2"-M1/2" BSP
	073-1402-515	15 m	3/4"	21 bar	F1"-M3/4" BSP







HD-555	Article	L. hose	Ø hose	Max pressure	Inlet-Outlet
	073-1502-400	without hose	-	-	F1/2"-M1/2" BSP
	073-1502-500	without hose	-	-	F1"-M3/4" BSP
	073-1502-600	without hose	-	-	F1"-M1" BSP
	073-1502-430	30 m	1/2"	28 bar	F1/2"-M1/2" BSP
	073-1502-520	20 m	3/4"	21 bar	F1"-M3/4" BSP
	073-1502-615	15 m	1"	20 bar	F1"-M1" BSP

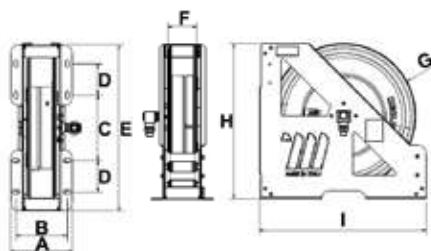

HD-560	Article	L. hose	Ø hose	Max pressure	Inlet-Outlet
	073-1602-400	without hose	-	-	F1/2"-M1/2" BSP
	073-1602-500	without hose	-	-	F1"-M3/4" BSP
	073-1602-600	without hose	-	-	F1"-M1" BSP
	073-1602-440	40 m	1/2"	28 bar	F1/2"-M1/2" BSP
	073-1602-450	50 m	1/2"	28 bar	F1/2"-M1/2" BSP
	073-1602-530	30 m	3/4"	21 bar	F1"-M3/4" BSP
	073-1602-540	40 m	3/4"	21 bar	F3/4"-M3/4" BSP
	073-1602-620	20 m	1"	20 bar	F1"-M1" BSP
	073-1602-630	30 m	1"	20 bar	F1"-M1" BSP

## OVERALL DIMENSIONS



Mod.	A	B	C	D	E	F	G	H	I			
HD-460	196	163	209	100	529	95	460	495	534	23,30<27,87	0,072	1
HD-550	230	197	324	100	644	120	550	597	649	39,92<46,08	0,120	1
HD-555	280	247	324	100	644	170	550	597	649	51,41<60,27	0,145	1
HD-560	460	427	324	100	644	350	550	597	649	60,62<78,20	0,230	1

# AUTOMATIC HOSE REELS IN PAINTED STEEL SERIES HEAVY - DUTY FOR WATER 150 °C 200 bar

Equipped with:

- Blue no trace synthetic rubber hoses 1SC
- Galvanized steel connections
- AISI 304 stainless steel 90° swivelling joint
- Viton® seals

Article	L. hose	Ø hose	Max pressure	Inlet-Outlet
073-1305-300	without hose	-	-	F1/2" - M3/8" BSP
073-1305-400	without hose	-	-	F1/2" - M1/2" BSP
073-1304-220	20 m	5/16"	200 bar	F1/2" - F3/8" BSP
073-1304-315	15 m	3/8"	200 bar	F1/2" - F3/8" BSP
073-1304-318	18 m	3/8"	200 bar	F1/2" - F3/8" BSP
073-1304-415	15 m	1/2"	200 bar	F1/2" - F1/2" BSP

HD-460



Article	L. hose	Ø hose	Max pressure	Inlet-Outlet
073-1405-300	without hose	-	-	F1/2" - M3/8" BSP
073-1405-400	without hose	-	-	F1/2" - M1/2" BSP
073-1404-320	20 m	3/8"	200 bar	F1/2" - F3/8" BSP
073-1404-325	25 m	3/8"	200 bar	F1/2" - F3/8" BSP
073-1404-420	20 m	1/2"	200 bar	F1/2" - F1/2" BSP
073-1404-425	25 m	1/2"	200 bar	F1/2" - F1/2" BSP

HD-550



Article	L. hose	Ø hose	Max pressure	Inlet-Outlet
073-1505-300	without hose	-	-	F1/2" - M3/8" BSP
073-1505-400	without hose	-	-	F1/2" - M1/2" BSP
073-1504-330	30 m	3/8"	200 bar	F1/2" - F3/8" BSP
073-1504-430	30 m	1/2"	200 bar	F1/2" - F1/2" BSP

HD-555





Article	L. hose	Ø hose	Max pressure	Inlet-Outlet
073-1605-300	without hose	-	-	F1/2" - M3/8" BSP
073-1605-400	without hose	-	-	F1/2" - M1/2" BSP
073-1604-340	40 m	3/8"	200 bar	F1/2" - F3/8" BSP
073-1604-350	50 m	3/8"	200 bar	F1/2" - F3/8" BSP
073-1604-440	40 m	1/2"	200 bar	F1/2" - F1/2" BSP

HD-560



## OVERALL DIMENSIONS

Mod.	A	B	C	D	E	F	G	H	I			
HD-460	196	163	209	100	529	95	460	495	534	23,26<29,60	0,072	1
HD-550	230	197	324	100	644	120	550	597	649	39,92<53,40	0,120	1
HD-555	280	247	324	100	644	170	550	597	649	51,40<66,90	0,145	1
HD-560	460	427	324	100	644	350	550	597	649	60,67<75,69	0,230	1

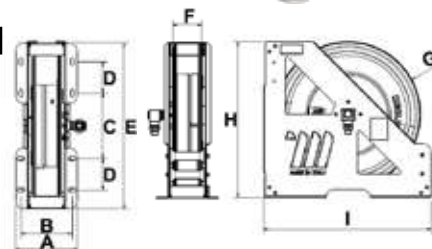

# AUTOMATIC HOSE REELS IN PAINTED STEEL SERIES HEAVY - DUTY FOR WATER 150 °C 400 bar

Equipped with:

- Blue no trace synthetic rubber hoses 2SC
- Galvanized steel connections
- AISI 304 stainless steel 90° swivelling joint
- Viton® seals



HD-460	Article	L. hose	Ø hose	Max pressure	Inlet-Outlet
	073-1305-300	without hose	-	-	F1/2"-M3/8" BSP
	073-1305-400	without hose	-	-	F1/2"-M1/2" BSP
	073-1305-220	20 m	5/16"	400 bar	F1/2"-F3/8" BSP
	073-1305-315	15 m	3/8"	400 bar	F1/2"-F3/8" BSP
	073-1305-318	18 m	3/8"	400 bar	F1/2"-F3/8" BSP
	073-1305-415	15 m	1/2"	400 bar	F1/2"-F1/2" BSP



HD-550	Article	L. hose	Ø hose	Max pressure	Inlet-Outlet
	073-1405-300	without hose	-	-	F1/2"-M3/8" BSP
	073-1405-400	without hose	-	-	F1/2"-M1/2" BSP
	073-1405-320	20 m	3/8"	400 bar	F1/2"-F3/8" BSP
	073-1405-325	25 m	3/8"	400 bar	F1/2"-F3/8" BSP
	073-1405-420	20 m	1/2"	400 bar	F1/2"-F1/2" BSP
	073-1405-425	25 m	1/2"	400 bar	F1/2"-F1/2" BSP





HD-555	Article	L. hose	Ø hose	Max pressure	Inlet-Outlet
	073-1505-300	without hose	-	-	F1/2"-M3/8" BSP
	073-1505-400	without hose	-	-	F1/2"-M1/2" BSP
	073-1505-330	30 m	3/8"	400 bar	F1/2"-F3/8" BSP
	073-1505-430	30 m	1/2"	400 bar	F1/2"-F1/2" BSP

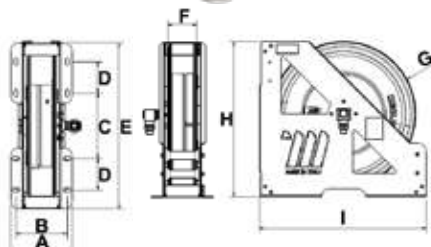

HD-560	Article	L. hose	Ø hose	Max pressure	Inlet-Outlet
	073-1605-300	without hose	-	-	F1/2"-M3/8" BSP
	073-1605-400	without hose	-	-	F1/2"-M1/2" BSP
	073-1605-340	40 m	3/8"	400 bar	F1/2"-F3/8" BSP
	073-1605-350	50 m	3/8"	400 bar	F1/2"-F3/8" BSP
	073-1605-440	40 m	1/2"	400 bar	F1/2"-F1/2" BSP

## OVERALL DIMENSIONS



Mod.	A	B	C	D	E	F	G	H	I			
HD-460	196	163	209	100	529	95	460	495	534	23,26<31,40	0,072	1
HD-550	230	197	324	100	644	120	550	597	649	39,92<53,40	0,120	1
HD-555	280	247	324	100	644	170	550	597	649	51,40<66,90	0,145	1
HD-560	460	427	324	100	644	350	550	597	649	60,67<81,67	0,230	1

# AUTOMATIC HOSE REELS IN PAINTED STEEL SERIES HEAVY - DUTY FOR OIL, ANTIFREEZE AND SIMILAR FROM 88 TO 180 bar

Equipped with:

- Black synthetic rubber hoses 1SC
- Galvanized steel connections
- Galvanized steel 90° swivelling joint
- Polyurethane seals

Article	L. hose	Ø hose	Max pressure	Inlet-Outlet
073-1306-400	without hose	-	-	F1/2"-M1/2" BSP
073-1306-415	15 m	1/2"	160 bar	F1/2"-M1/2" BSP
073-1306-418	18 m	1/2"	160 bar	F1/2"-M1/2" BSP

HD-460



Article	L. hose	Ø hose	Max pressure	Inlet-Outlet
073-1406-400	without hose	-	-	F1/2"-M1/2" BSP
073-1406-500	without hose	-	-	F1"-M3/4" BSP
073-1406-420	20 m	1/2"	160 bar	F1/2"-M1/2" BSP
073-1406-425	25 m	1/2"	160 bar	F1/2"-M1/2" BSP
073-1406-515	15 m	3/4"	105 bar	F1"-M3/4" BSP

HD-550



Article	L. hose	Ø hose	Max pressure	Inlet-Outlet
073-1506-400	without hose	-	-	F1/2"-M1/2" BSP
073-1506-500	without hose	-	-	F1"-M3/4" BSP
073-1506-600	without hose	-	-	F1"-M1" BSP
073-1506-430	30 m	1/2"	160 bar	F1/2"-M1/2" BSP
073-1506-520	20 m	3/4"	105 bar	F1"-M3/4" BSP
073-1506-615	15 m	1"	88 bar	F1"-M1" BSP

HD-555





Article	L. hose	Ø hose	Max pressure	Inlet-Outlet
073-1606-400	without hose	-	-	F1/2"-M1/2" BSP
073-1606-500	without hose	-	-	F1"-M3/4" BSP
073-1606-600	without hose	-	-	F1"-M1" BSP
073-1606-440	40 m	1/2"	160 bar	F1/2"-M1/2" BSP
073-1606-450	50 m	1/2"	160 bar	F1/2"-M1/2" BSP
073-1606-530	30 m	3/4"	105 bar	F1"-M3/4" BSP
073-1606-540	40 m	3/4"	105 bar	F1"-M3/4" BSP
073-1606-620	20 m	1"	88 bar	F1"-M1" BSP
073-1606-630	30 m	1"	88 bar	F1"-M1" BSP

HD-560



## OVERALL DIMENSIONS

Mod.	A	B	C	D	E	F	G	H	I			
HD-460	196	163	209	100	529	95	460	495	534	23,26<29,91	0,072	1
HD-550	230	197	324	100	644	120	550	597	649	39,90<48,74	0,120	1
HD-555	280	247	324	100	644	170	550	597	649	51,40<63,94	0,145	1
HD-560	460	427	324	100	644	350	550	597	649	60,66<82,88	0,230	1

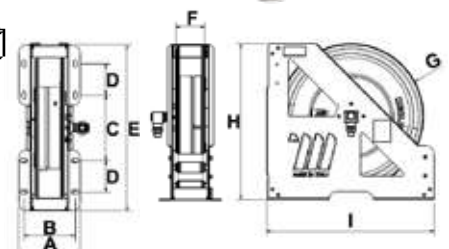

# AUTOMATIC HOSE REELS IN PAINTED STEEL SERIES HEAVY - DUTY FOR GREASE FROM 275 TO 400 bar

Equipped with:

- Black synthetic rubber hoses 2SC
- Galvanized steel connections
- Galvanized steel 90° swivelling joint
- Polyurethane seals



HD-460	Article	L. hose	Ø hose	Max pressure	Inlet-Outlet
	073-1307-200	without hose	-	-	M1/4"-M1/4" BSP
	073-1307-300	without hose	-	-	M3/8"-M3/8" BSP
	073-1307-400	without hose	-	-	M1/2"-M1/2" BSP
	073-1307-118	18 m	1/4"	400 bar	M1/4"-M1/4" BSP
	073-1307-315	15 m	3/8"	330 bar	M3/8"-M3/8" BSP
	073-1307-415	15 m	1/2"	275 bar	M1/2"-M1/2" BSP





HD-550	Article	L. hose	Ø hose	Max pressure	Inlet-Outlet
	073-1407-300	without hose	-	-	M3/8"-M3/8" BSP
	073-1407-400	without hose	-	-	M1/2"-M1/2" BSP
	073-1407-320	20 m	3/8"	330 bar	M3/8"-M3/8" BSP
	073-1407-325	25 m	3/8"	330 bar	M3/8"-M3/8" BSP
	073-1407-420	20 m	1/2"	275 bar	M1/2"-M1/2" BSP
	073-1407-425	25 m	1/2"	275 bar	M1/2"-M1/2" BSP

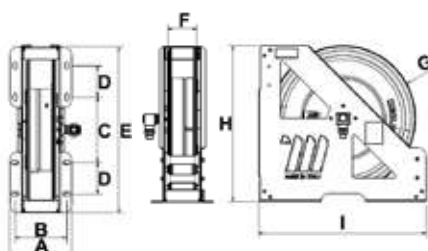

HD-555	Article	L. hose	Ø hose	Max pressure	Inlet-Outlet
	073-1507-300	without hose	-	-	M3/8"-M3/8" BSP
	073-1507-400	without hose	-	-	M1/2"-M1/2" BSP
	073-1507-330	30 m	3/8"	330 bar	M3/8"-M3/8" BSP
	073-1507-430	30 m	1/2"	275 bar	M1/2"-M1/2" BSP



## OVERALL DIMENSIONS

Mod.	A	B	C	D	E	F	G	H	I			
HD-460	196	163	209	100	529	95	460	495	534	23,28<31,98	0,072	1
HD-550	230	197	324	100	644	120	550	597	649	39,90<54,60	0,120	1
HD-555	280	247	324	100	644	170	550	597	649	51,40<68,70	0,145	1

# AUTOMATIC HOSE REELS IN PAINTED STEEL SERIES HEAVY - DUTY FOR ANTIFREEZE - WINDSCREEN - AdBlue® 20 bar

Equipped with:

- Black antistatic synthetic rubber EPDM hoses
- AISI 316 stainless steel connections
- AISI 316 stainless steel 90° swivelling joint
- Viton® seals
- Stainless steel reel shaft

Article	L. hose	Ø hose	Max pressure	Inlet-Outlet
073-1309-400	without hose	-	-	F1/2"-M1/2" BSP
073-1309-410	10 m	1/2" - 12,7x21	20 bar	F1/2"-M1/2" BSP
073-1309-415	15 m	1/2" - 12,7x21	20 bar	F1/2"-F1/2" BSP

HD-460



Article	L. hose	Ø hose	Max pressure	Inlet-Outlet
073-1409-400	without hose	-	-	F1/2"-M1/2" BSP
073-1409-500	without hose	-	-	F1"-M3/4" BSP
073-1409-420	20 m	1/2"	20 bar	F1/2"-M1/2" BSP
073-1409-425	25 m	1/2"	20 bar	F1/2"G-M 1/2" BSP
073-1409-510	10 m	3/4"	20 bar	F1"-M3/4" BSP
073-1409-515	15 m	3/4"	20 bar	F1"-M3/4" BSP

HD-550



Article	L. hose	Ø hose	Max pressure	Inlet-Outlet
073-1509-500	without hose	-	-	F1"-M3/4" BSP
073-1509-520	20 m	3/4"	20 bar	F1"-M3/4" BSP

HD-555



## OVERALL DIMENSIONS

Mod.	A	B	C	D	E	F	G	H	I	Kg	m³	kg
HD-460	196	163	209	100	529	95	460	495	534	23,26<27,65	0,072	1
HD-550	230	197	324	100	644	120	550	597	649	39,92<47,43	0,120	1
HD-555	280	247	324	100	644	170	550	597	649	51,95<61,10	0,145	1

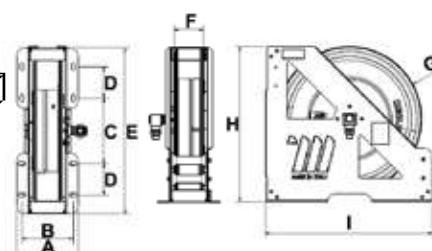

# AUTOMATIC HOSE REELS IN PAINTED STEEL SERIES HEAVY - DUTY FOR DIESEL 10 bar



Equipped with:

- Black antistatic rubber hoses
- Galvanized steel connections
- Galvanized steel - anodized aluminium 90° swivelling joint
- Viton® seals

**HD-460**

Article	Capacity	L. hose	Ø hose	Inlet-Outlet
073-1308-500	80 l/min	without hose	-	F1"-M3/4"BSP
073-1308-508	80 l/min	8 m	3/4"- 19x27	F1"- M1"BSP



**HD-550**

Article	Capacity	L. hose	Ø hose	Inlet-Outlet
073-1408-600	95 l/min	without hose	-	F1"-M1" BSP
073-1408-510	90 l/min	10 m	3/4"- 19x27	F1"-M1" BSP
073-1408-515	85 l/min	15 m	3/4"- 19x27	F1"-M1" BSP
073-1408-610	95 l/min	10 m	1" - 25x35	F1"-M1" BSP



**HD-555**



Article	Capacity	L. hose	Ø hose	Inlet-Outlet
073-1508-600	95 l/min	without hose	-	F1"-M1" BSP
073-1508-520	83 l/min	20 m	3/4"- 19x27	F1"-M1" BSP
073-1508-615	90 l/min	15 m	1" - 25x35	F1"-M1" BSP



**HD-560**

Article	Capacity	L. hose	Ø hose	Inlet-Outlet
073-1608-600	95 l/min	without hose	-	F1"-M1" BSP
073-1608-530	80 l/min	30 m	3/4"- 19x27	F1"-M1" BSP
073-1608-540	75 l/min	40 m	3/4"- 19x27	F1"-M1" BSP
073-1608-620	87 l/min	20 m	1" - 25x35	F1"-M1" BSP
073-1608-630	85 l/min	30 m	1" - 25x35	F1"-M1" BSP

## OVERALL DIMENSIONS

Mod.	A	B	C	D	E	F	G	H	I			
HD-460	196	163	209	100	529	95	460	495	534	23,28<26,78	0,072	1
HD-550	230	197	324	100	644	120	550	597	649	40,10<47,35	0,120	1
HD-555	280	247	324	100	644	170	550	597	649	51,50<62,53	0,145	1
HD-560	460	427	324	100	644	350	550	597	649	60,90<83,02	0,230	1

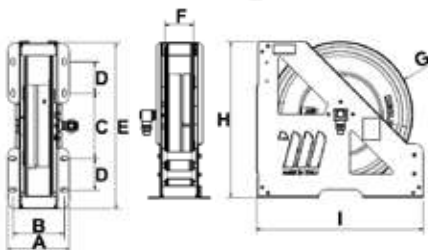

# AUTOMATIC HOSE REELS IN PAINTED STEEL SERIES HEAVY - DUTY FOR GASOLINE 16 bar

Equipped with:

- Black antistatic synthetic rubber hoses steel wire helix with high strength synthetic textile plies, copper wire
- Reference regulations: EN 1761 - EN 12115 ATEX (EX ZONE)
- Self-extinguishing according to: TRbf 131/2
- Galvanized steel connections
- Galvanized steel 90° swivelling joint - Viton® seals
- Compliant with ATEX directive (see ATEX regulation at page 390)

CE Ex II 2 G Ex h IIB T4 Gb X  
II 2 D Ex h IIIC T4 Db

Article	Capacity	L. hose	Ø hose	Inlet-Outlet	HD-550
073-1418-600	95 l/min	without hose	-	F1"-M1" BSP	
073-1418-510	90 l/min	10 m	3/4"- 19x27	F1"-M1" BSP	
073-1418-515	85 l/min	15 m	3/4"- 19x27	F1"-M1" BSP	
073-1418-610	95 l/min	10 m	1" - 25x35	F1"-M1" BSP	



Article	Capacity	L. hose	Ø hose	Inlet-Outlet	HD-555
073-1518-600	95 l/min	without hose	-	F1"-M1" BSP	
073-1518-520	83 l/min	20 m	3/4"- 19x27	F1"-M1" BSP	
073-1518-615	90 l/min	15 m	1" - 25x35	F1"-M1" BSP	



Article	Capacity	L. hose	Ø hose	Inlet-Outlet	HD-560
073-1618-600	95 l/min	without hose	-	F1"-M1" BSP	
073-1618-530	80 l/min	30 m	3/4"- 19x27	F1"-M1" BSP	
073-1618-620	87 l/min	20 m	1" - 25x35	F1"-M1" BSP	
073-1618-630	85 l/min	30 m	1" - 25x35	F1"-M1" BSP	



## OVERALL DIMENSIONS

Mod.	A	B	C	D	E	F	G	H	I	Kg	m³	Nº
HD-550	230	197	324	100	644	120	550	597	649	40,45<51,00	0,120	1
HD-555	280	247	324	100	644	170	550	597	649	51,94<66,00	0,145	1
HD-560	460	427	324	100	644	350	550	597	649	61,30<85,00	0,230	1

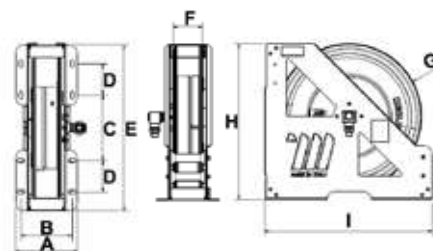

# AUTOMATIC HOSE REELS IN AISI 304 STAINLESS STEEL SERIES HEAVY - DUTY FOR AIR-WATER FROM 20 TO 28 bar

Equipped with:

- Black synthetic rubber hoses R6
- Galvanized steel connections
- Brass 90° swivelling joint
- Viton® seals



HDX-460	Article	L. hose	Ø hose	Max pressure	Inlet-Outlet
	073-2302-400	without hose	-	-	F1/2"-M1/2"BSP
	073-2302-415	15 m	1/2"	28 bar	F1/2"-M1/2" BSP
	073-2302-418	18 m	1/2"	28 bar	F1/2"-M1/2" BSP



HDX-550	Article	L. hose	Ø hose	Max pressure	Inlet-Outlet
	073-2402-400	without hose	-	-	F1/2"-M1/2" BSP
	073-2402-500	without hose	-	-	F1"-M3/4" BSP
	073-2402-420	20 m	1/2"	28 bar	F1/2"-M1/2" BSP
	073-2402-425	25 m	1/2"	28 bar	F1/2"-M1/2" BSP
	073-2402-515	15 m	3/4"	21 bar	F1"-M3/4" BSP







HDX-555	Article	L. hose	Ø hose	Max pressure	Inlet-Outlet
	073-2502-400	without hose	-	-	F1/2"-M1/2" BSP
	073-2502-500	without hose	-	-	F1"-M3/4" BSP
	073-2502-600	without hose	-	-	F1"-M1" BSP
	073-2502-430	30 m	1/2"	28 bar	F1/2"-M1/2" BSP
	073-2502-520	20 m	3/4"	21 bar	F1"-M3/4" BSP
	073-2502-615	15 m	1"	20 bar	F1"-M1" BSP

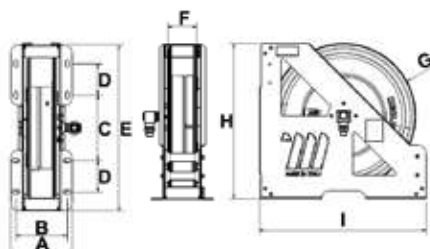

HDX-560	Article	L. hose	Ø hose	Max pressure	Inlet-Outlet
	073-2602-400	without hose	-	-	F1/2"-M1/2" BSP
	073-2602-500	without hose	-	-	F1"-M3/4" BSP
	073-2602-600	without hose	-	-	F1"-M1" BSP
	073-2602-440	40 m	1/2"	28 bar	F1/2"-M1/2" BSP
	073-2602-450	50 m	1/2"	28 bar	F1/2"-M1/2" BSP
	073-2602-530	30 m	3/4"	21 bar	F1"-M3/4" BSP
	073-2602-540	40 m	3/4"	21 bar	F3/4"-M3/4" BSP
	073-2602-620	20 m	1"	20 bar	F1"-M1" BSP
	073-2602-630	30 m	1"	20 bar	F1"-M1" BSP

## OVERALL DIMENSIONS



Mod.	A	B	C	D	E	F	G	H	I			
HDX-460	196	163	209	100	529	95	460	495	534	22,63<27,20	0,072	1
HDX-550	230	197	324	100	644	120	550	597	649	39,05<45,33	0,120	1
HDX-555	280	247	324	100	644	170	550	597	649	50,50<59,52	0,145	1
HDX-560	460	427	324	100	644	350	550	597	649	59,50<77,10	0,230	1

# AUTOMATIC HOSE REELS IN AISI 304 STAINLESS STEEL SERIES HEAVY - DUTY FOR WATER 150 °C 200 bar

Equipped with:

- Blue no trace synthetic rubber hoses 1SC
- Galvanized steel connections
- AISI 304 stainless steel 90° swivelling joint
- Viton® seals

Article	L. hose	Ø hose	Max pressure	Inlet-Outlet
073-2305-300	without hose	-	-	F1/2"-M3/8" BSP
073-2305-400	without hose	-	-	F1/2"-M1/2" BSP
073-2304-220	20 m	5/16"	200 bar	F1/2"-F3/8" BSP
073-2304-315	15 m	3/8"	200 bar	F1/2"-F3/8" BSP
073-2304-318	18 m	3/8"	200 bar	F1/2"-F3/8" BSP
073-2304-415	15 m	1/2"	200 bar	F1/2"-F1/2" BSP

HDX-460



Article	L. hose	Ø hose	Max pressure	Inlet-Outlet
073-2405-300	without hose	-	-	F1/2"-M3/8" BSP
073-2405-400	without hose	-	-	F1/2"-M1/2" BSP
073-2404-320	20 m	3/8"	200 bar	F1/2"-F3/8" BSP
073-2404-325	25 m	3/8"	200 bar	F1/2"-F3/8" BSP
073-2404-420	20 m	1/2"	200 bar	F1/2"-F1/2" BSP
073-2404-425	25 m	1/2"	200 bar	F1/2"-F1/2" BSP

HDX-550



Article	L. hose	Ø hose	Max pressure	Inlet-Outlet
073-2505-300	without hose	-	-	F1/2"-M3/8" BSP
073-2505-400	without hose	-	-	F1/2"-M1/2" BSP
073-2504-330	30 m	3/8"	200 bar	F1/2"-F3/8" BSP
073-2504-430	30 m	1/2"	200 bar	F1/2"-F1/2" BSP

HDX-555





Article	L. hose	Ø hose	Max pressure	Inlet-Outlet
073-2605-300	without hose	-	-	F1/2"-M3/8" BSP
073-2605-400	without hose	-	-	F1/2"-M1/2" BSP
073-2604-340	40 m	3/8"	200 bar	F1/2"-F3/8" BSP
073-2604-350	50 m	3/8"	200 bar	F1/2"-F3/8" BSP
073-2604-440	40 m	1/2"	200 bar	F1/2"-F1/2" BSP

HDX-560



## OVERALL DIMENSIONS

Mod.	A	B	C	D	E	F	G	H	I			
HDX-460	196	163	209	100	529	95	460	495	534	22,60<28,94	0,072	1
HDX-550	230	197	324	100	644	120	550	597	649	39,05<48,15	0,120	1
HDX-555	280	247	324	100	644	170	550	597	649	50,50<61,38	0,145	1
HDX-560	460	427	324	100	644	350	550	597	649	59,50<74,52	0,230	1

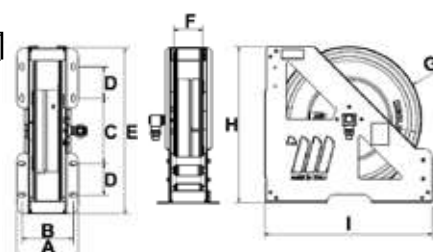

# AUTOMATIC HOSE REELS IN AISI 304 STAINLESS STEEL SERIES HEAVY - DUTY FOR WATER 150 °C 400 bar

Equipped with:

- Blue no trace synthetic rubber hoses 2SC
- Galvanized steel connections
- AISI 304 stainless steel 90° swivelling joint
- Teflon seals



HDX-460	Article	L. hose	Ø hose	Max pressure	Inlet-Outlet
	073-2305-300	without hose	-	-	F1/2"-M3/8" BSP
	073-2305-400	without hose	-	-	F1/2"-M1/2" BSP
	073-2305-220	20 m	5/16"	400 bar	F1/2"-F3/8" BSP
	073-2305-315	15 m	3/8"	400 bar	F1/2"-F3/8" BSP
	073-2305-318	18 m	3/8"	400 bar	F1/2"-F3/8" BSP
	073-2305-415	15 m	1/2"	400 bar	F1/2"-F1/2" BSP



HDX-550	Article	L. hose	Ø hose	Max pressure	Inlet-Outlet
	073-2405-300	without hose	-	-	F1/2"-M3/8" BSP
	073-2405-400	without hose	-	-	F1/2"-M1/2" BSP
	073-2405-320	20 m	3/8"	400 bar	F1/2"-F3/8" BSP
	073-2405-325	25 m	3/8"	400 bar	F1/2"-F3/8" BSP
	073-2405-420	20 m	1/2"	400 bar	F1/2"-F1/2" BSP
	073-2405-425	25 m	1/2"	400 bar	F1/2"-F1/2" BSP







HDX-555	Article	L. hose	Ø hose	Max pressure	Inlet-Outlet
	073-2505-300	without hose	-	-	F1/2"-M3/8" BSP
	073-2505-400	without hose	-	-	F1/2"-M1/2" BSP
	073-2505-330	30 m	3/8"	400 bar	F1/2"-F3/8" BSP
	073-2505-430	30 m	1/2"	400 bar	F1/2"-F1/2" BSP

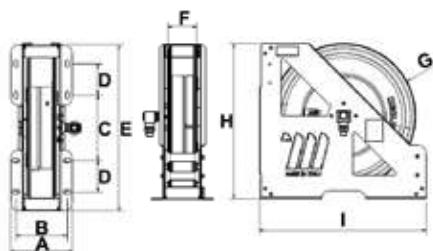

HDX-560	Article	L. hose	Ø hose	Max pressure	Inlet-Outlet
	073-2605-300	without hose	-	-	F1/2"-M3/8" BSP
	073-2605-400	without hose	-	-	F1/2"-M1/2" BSP
	073-2605-340	40 m	3/8"	400 bar	F1/2"-F3/8" BSP
	073-2605-350	50 m	3/8"	400 bar	F1/2"-F3/8" BSP
	073-2605-440	40 m	1/2"	400 bar	F1/2"-F1/2" BSP

## OVERALL DIMENSIONS



Mod.	A	B	C	D	E	F	G	H	I			
HDX-460	196	163	209	100	529	95	460	495	534	22,60<30,74	0,072	1
HDX-550	230	197	324	100	644	120	550	597	649	39,05<52,53	0,120	1
HDX-555	280	247	324	100	644	170	550	597	649	50,50<66,00	0,145	1
HDX-560	460	427	324	100	644	350	550	597	649	59,50<80,50	0,230	1

# AUTOMATIC HOSE REELS IN AISI 304 STAINLESS STEEL SERIES HEAVY - DUTY FOR ANTIFREEZE - WINDSCREEN - AdBlue® 20 bar

Equipped with:

- Black antistatic synthetic rubber EPDM hoses
- AISI 316 stainless steel connections
- AISI 316 stainless steel 90° swivelling joint
- Viton® seals

Article	L. hose	Ø hose	Max pressure	Inlet-Outlet	HDX-460
073-2309-400	without hose	-	-	F1/2"-M1/2" BSP	
073-2309-410	10 m	1/2" - 12,7x21	20 bar	F1/2"-M1/2" BSP	
073-2309-415	15 m	1/2" - 12,7x21	20 bar	F1/2"-F1/2" BSP	



Article	L. hose	Ø hose	Max pressure	Inlet-Outlet	HDX-550
073-2409-400	without hose	-	-	F1/2"-M1/2" BSP	
073-2409-500	without hose	-	-	F1"-M3/4" BSP	
073-2409-420	20 m	1/2"	20 bar	F1/2"-M1/2" BSP	
073-2409-425	25 m	1/2"	20 bar	F1/2"-M 1/2" BSP	
073-2409-510	10 m	3/4"	20 bar	F1"-M3/4" BSP	
073-2409-515	15 m	3/4"	20 bar	F1"-M3/4" BSP	



Article	L. hose	Ø hose	Max pressure	Inlet-Outlet	HDX-555
073-2509-500	without hose	-	-	F1"-M3/4" BSP	
073-2509-520	20 m	3/4"	20 bar	F1"-M3/4" BSP	



## OVERALL DIMENSIONS

Mod.	A	B	C	D	E	F	G	H	I	Kg	m³	№
HDX-460	196	163	209	100	529	95	460	495	534	22,60<27,00	0,072	1
HDX-550	230	197	324	100	644	120	550	597	649	39,05<46,03	0,120	1
HDX-555	280	247	324	100	644	170	550	597	649	50,50<59,65	0,145	1

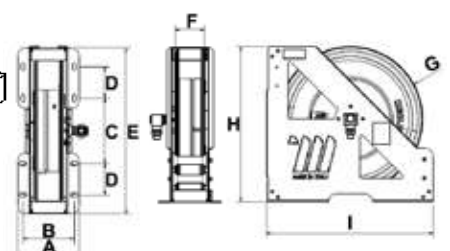

# AUTOMATIC HOSE REELS IN AISI 304 STAINLESS STEEL SERIES HEAVY - DUTY FOR DIESEL 10 bar

Equipped with:

- Black antistatic rubber hoses
- Galvanized steel connections
- Galvanized steel - anodized aluminum 90° swivelling joint
- Viton® seals



HDX-460	Article	Capacity	L. hose	Ø hose	Inlet-Outlet
	073-2308-500	80 l/min	without hose	-	F1"-M3/4"BSP
	073-2308-508	80 l/min	8 m	3/4"- 19x27	F1"-M1" BSP



HDX-550	Article	Capacity	L. hose	Ø hose	Inlet-Outlet
	073-2408-600	95 l/min	without hose	-	F1"-M1" BSP
	073-2408-510	90 l/min	10 m	3/4"- 19x27	F1"-M1" BSP
	073-2408-515	85 l/min	15 m	3/4"- 19x27	F1"-M1" BSP
	073-2408-610	95 l/min	10 m	1" - 25x35	F1"-M1" BSP







HDX-555	Article	Capacity	L. hose	Ø hose	Inlet-Outlet
	073-2508-600	95 l/min	without hose	-	F1"-M1" BSP
	073-2508-520	83 l/min	20 m	3/4"- 19x27	F1"-M1" BSP
	073-2508-615	90 l/min	15 m	1" - 25x35	F1"-M1" BSP

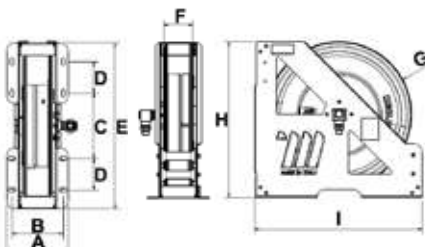

HDX-560	Article	Capacity	L. hose	Ø hose	Inlet-Outlet
	073-2608-600	95 l/min	without hose	-	F1"-M1" BSP
	073-2608-530	80 l/min	30 m	3/4"- 19x27	F1"-M1" BSP
	073-2608-540	75 l/min	40 m	3/4"- 19x27	F1"-M1" BSP
	073-2608-620	87 l/min	20 m	1" - 25x35	F1"-M1" BSP
	073-2608-630	85 l/min	30 m	1" - 25x35	F1"-M1" BSP

## OVERALL DIMENSIONS





Mod.	A	B	C	D	E	F	G	H	I			
HDX-460	196	163	209	100	529	95	460	495	534	23,28<26,78	0,072	1
HDX-550	230	197	324	100	644	120	550	597	649	40,10<47,35	0,120	1
HDX-555	280	247	324	100	644	170	550	597	649	51,50<62,53	0,145	1
HDX-560	460	427	324	100	644	350	550	597	649	60,90<83,02	0,230	1

# AUTOMATIC HOSE REELS IN AISI 304 STAINLESS STEEL SERIES HEAVY - DUTY FOR GASOLINE 16 bar

Equipped with:

- Black antistatic synthetic rubber hoses steel wire helix with high strength synthetic textile plies, copper wire
- Reference regulations: EN 1761 - EN 12115 ATEX (EX ZONE)
- Self-extinguishing according to: TRbf 131/2
- Galvanized steel connections
- Stainless steel 90° swivelling joint - Viton® seals
- Compliant with ATEX directive (see ATEX regulation at page 390)



CE  II 2 G Ex h IIB T4 Gb X  
II 2 D Ex h IIIC T4 Db

Article	Capacity	L. hose	Ø hose	Inlet-Outlet	HDX-550
073-2418-600	95 l/min	without hose	-	F1"-M1" BSP	
073-2418-510	90 l/min	10 m	3/4"- 19x27	F1"-M1" BSP	
073-2418-515	85 l/min	15 m	3/4"- 19x27	F1"-M1" BSP	
073-2418-610	95 l/min	10 m	1" - 25x35	F1"-M1" BSP	

Article	Capacity	L. hose	Ø hose	Inlet-Outlet	HDX-555
073-2518-600	95 l/min	without hose	-	F1"-M1" BSP	
073-2518-520	83 l/min	20 m	3/4"- 19x27	F1"-M1" BSP	
073-2518-615	90 l/min	15 m	1" - 25x35	F1"-M1" BSP	

Article	Capacity	L. hose	Ø hose	Inlet-Outlet	HDX-560
073-2618-600	95 l/min	without hose	-	F1"-M1" BSP	
073-2618-530	80 l/min	30 m	3/4"- 19x27	F1"-M1" BSP	
073-2618-620	87 l/min	20 m	1" - 25x35	F1"-M1" BSP	
073-2618-630	85 l/min	30 m	1" - 25x35	F1"-M1" BSP	

## OVERALL DIMENSIONS

Mod.	A	B	C	D	E	F	G	H	I			
HDX-550	230	197	324	100	644	120	550	597	649	40,45<51,00	0,120	1
HDX-555	280	247	324	100	644	170	550	597	649	51,94<66,00	0,145	1
HDX-560	460	427	324	100	644	350	550	597	649	61,30<85,00	0,230	1

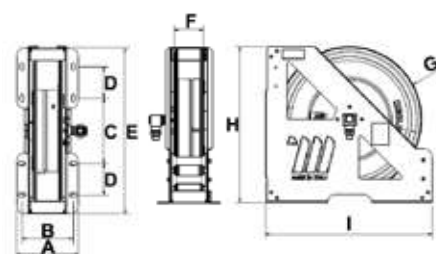

# AUTOMATIC INDUSTRIAL HOSE REEL FA-600 SERIES

Automatic auto-retractable hose reel in painted steel, designed for applications which require solid equipment, also on vehicles.

It is suitable for flexible hoses of maximum  $\varnothing$  of 1.1/2" for the distribution of compressed air, oil and similar fluids, fuels.

**They can have two different hose output positions: superior and inferior.**

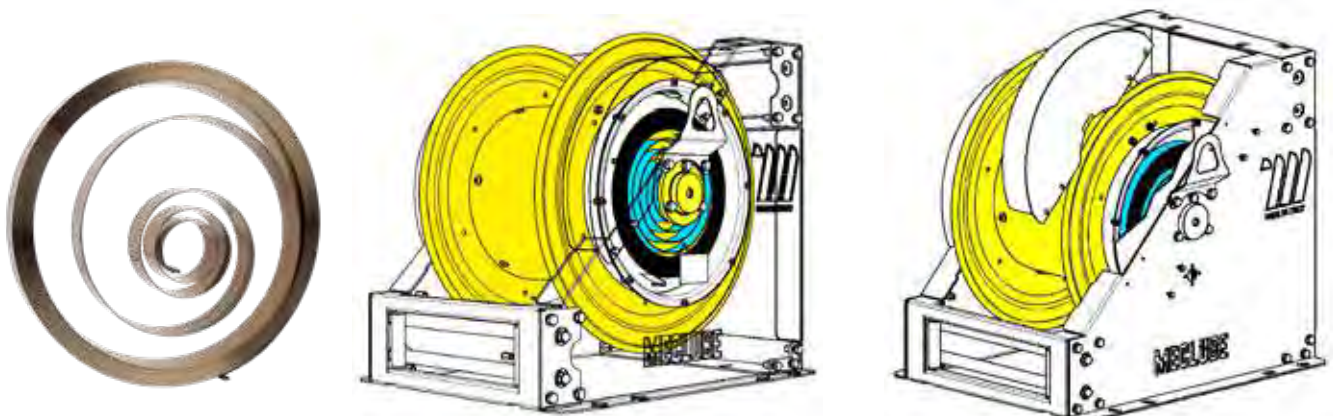

# AUTOMATIC INDUSTRIAL SPRING HOSE REEL IN PAINTED STEEL FA-600 SERIES

## For air-water 20 bar

Equipped with:

- Black synthetic rubber hoses AERTUB/20
- Galvanized steel connections
- Anodized aluminium swivelling joint
- Viton® seals

Article	L. hose	Ø hose	Max pressure	Inlet-Outlet
076-6102-800	without hose	-	20 bar	F1.1/2"-F1.1/2" BSP
076-6102-715	15 m	1.1/4"	20 bar	F1.1/2"-M1.1/2" BSP
076-6102-720	20 m	1.1/4"	20 bar	F1.1/2"-M1.1/2" BSP
076-6102-815	15 m	1.1/2"	20 bar	F1.1/2"-M1.1/2" BSP



FA-600

## For oil and lubricant 250 bar

Equipped with:

- Black synthetic rubber hoses 1SC
- Galvanized steel connections
- Galvanized steel swivelling joint
- NBR seals

Article	L. hose	Ø hose	Max pressure	Inlet-Outlet
076-6106-800	without hose	-	250 bar	F1.1/2"-F1.1/2" BSP
076-6106-715	15 m	1.1/4"	63 bar	F1.1/2"-M1.1/2" BSP
076-6106-720	20 m	1.1/4"	63 bar	F1.1/2"-M1.1/2" BSP
076-6106-815	15 m	1.1/2"	50 bar	F1.1/2"-M1.1/2" BSP



FA-600

## For diesel 10 bar

Equipped with:

- Black antistatic synthetic rubber hoses steel wire helix with high strength syntetic textile plies, copper wire
- Galvanized steel connections
- Anodized aluminium swivelling joint
- Viton® seals

Article	L. hose	Ø hose	Max pressure	Inlet-Outlet
076-6108-800	without hose	-	20 bar	F1.1/2"-F1.1/2" BSP
076-6108-815	15 m	1.1/2"	10 bar	F1.1/2"-M1.1/2" BSP



FA-600

## OVERALL DIMENSIONS

Mod.	A	B	C	D	E	F	G	H	I	J	Kg	m³	1
FA-600	660	725	600	530	100	350	550	330	575	680	120,8<133,8	0,910	1

Automatic auto-retractable hose reel in painted steel, designed for applications which require solid equipment, also on vehicles. It is suitable for flexible hoses of maximum Ø of 1.1/2" for the distribution of compressed air, oil and similar fluids, fuels. They can have two different hose output positions: superior and inferior.

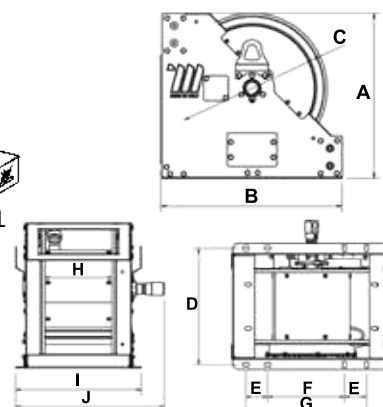

# INDUSTRIAL HOSE REELS Mod. 600

The motorized and manual industrial hose reels are designed for applications that require robust equipment, also on trucks. They are suitable for flexible hoses with big diameters for the distribution of compressed air, water, oil and similar, grease, diesel.

## - MOTORIZED 12-24V DC ELECTRIC WITH REDUCER

**The unwinding of the hose is manual while the rolling process is through the electric motor (12-24V DC).**

It can be connected to a battery or to a power transformer connected to the 230V network.



## - MOTORIZED 230-115V AC ELECTRIC WITH REDUCER

**The unwinding of the hose is manual while the rolling process is through the electric motor (230-115 AC).**

It has to be connected to the 230-115V AC electric network.



## - MOTORIZED HYDRAULIC

**The unwinding of the hose is manual while the rolling process is through the hydraulic motor.**

It has to be connected to a specific control unit equipped with electric motor, hydraulic oil tank and to a command-and-control system with lever for the rolling process.



## - MOTORIZED PNEUMATIC

**The unwinding of the hose is manual while the rolling process is through the pneumatic motor.**

It has to be connected to the compressed air supply and to a pressure regulator that allows to adjust the rolling power and speed.



## - MANUAL

**The unwinding of the hose is manual, while the rolling process is through the practical revolving crank.**

Resulting in a valid and economical solution to the problem of flexible hoses.

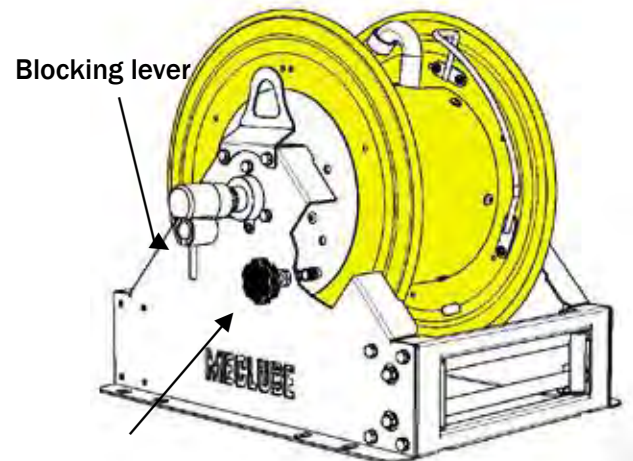
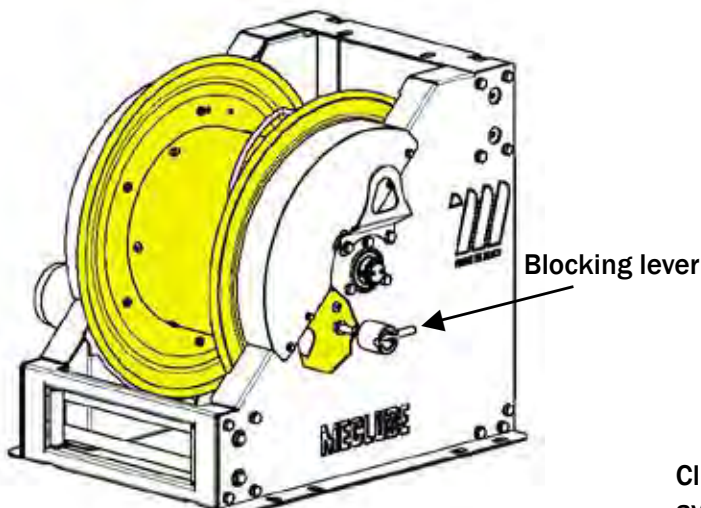

Clutch to regulate the hose unwinding and to avoid the reel to rotate loosely by inertia.

# INDUSTRIAL HOSE REELS Mod. 600

New series of motorized industrial hose reels Mod.600

They are supplied with reel  $\varnothing$  600 with 3 different widths: 330, 440, 550 mm

1" F swivelling joint with pressures of 20 and 300 bar. The main difference is the type of motorization:

- Electric gear motor 12V-24V-230V-115V with reducer
- Hydraulic
- Pneumatic
- Manual

They are designed for applications that require robust equipment, also on trucks.

They are suitable for flexible hoses with maximum  $\varnothing$  of 1", for the distribution of compressed air, water, oil and similar, grease, diesel.

**They are designed to have two different hose exit positions, an upper and a lower one.**

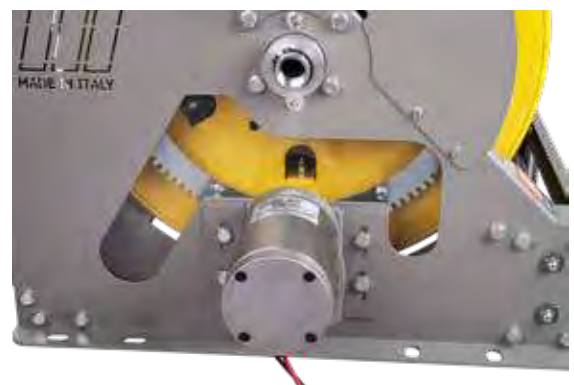

Direct motorized transmission  
with pinion on the sprocket

# INDUSTRIAL HOSE REELS IN PAINTED STEEL MOTORIZED 12V ELECTRIC SERIES Mod. FE-600



**FE-601**

## For air-water and diesel 20 bar

Equipped with:

- Brass swivelling joint - Viton® seals
- **Electric 12V DC motor** 430W power

Article	Model	Internal reel width	Inlet-Outlet
<b>076-6112-600</b>	<b>FE-601</b>	330 mm	F1"- F1" BSP
<b>076-6212-600</b>	<b>FE-602</b>	440 mm	F1"- F1" BSP
<b>076-6312-600</b>	<b>FE-603</b>	550 mm	F1"- F1" BSP

## For water 150° C 200 bar

Equipped with:

- AISI 304 stainless steel 90° swivelling joint - Viton® seals
- **Electric 12V DC motor** 430W power

Article	Model	Internal reel width	Inlet-Outlet
<b>076-6115-600</b>	<b>FE-601</b>	330 mm	F1"- F1" BSP
<b>076-6215-600</b>	<b>FE-602</b>	440 mm	F1"- F1" BSP
<b>076-6315-600</b>	<b>FE-603</b>	550 mm	F1"- F1" BSP

## For oil and lubricants 250 bar

Equipped with:

- Galvanized steel swivelling joint - NBR seals
- **Electric 12V DC motor** 430W power

Article	Model	Internal reel width	Inlet-Outlet
<b>076-6116-600</b>	<b>FE-601</b>	330 mm	F1"- F1" BSP
<b>076-6216-600</b>	<b>FE-602</b>	440 mm	F1"- F1" BSP
<b>076-6316-600</b>	<b>FE-603</b>	550 mm	F1"- F1" BSP

## For grease 300 bar

Equipped with:

- Galvanized steel swivelling joint - NBR seals
- **Electric 12V DC motor** 430W power

Article	Model	Internal reel width	Inlet-Outlet
<b>076-6117-600</b>	<b>FE-601</b>	330 mm	F1"- F1" BSP
<b>076-6217-600</b>	<b>FE-602</b>	440 mm	F1"- F1" BSP
<b>076-6317-600</b>	<b>FE-603</b>	550 mm	F1"- F1" BSP

## Hose reel capacity

Ø Hose	Ø external Hose	Mod.FE-601	Mod.FE-602	Mod.FE-603
<b>1/2"</b>	20 mm	<b>50 m</b>	<b>100 m</b>	<b>200 m</b>
<b>3/4"</b>	27 mm	<b>30 m</b>	<b>60 m</b>	<b>90 m</b>
<b>1"</b>	34 mm	<b>20 m</b>	<b>40 m</b>	<b>60 m</b>

## Overall dimensions

Model	A	B	C	D	E	F	G	H	I	J	Weight	Packaging
<b>FE-601</b>	660	733	600	530	100	350	550	330	580	810	114 kg	800X1200X950 mm
<b>FE-602</b>	660	733	600	640	100	350	550	440	690	920	119 kg	800X1200X950 mm
<b>FE-603</b>	660	733	600	750	100	350	550	550	800	1030	124 kg	800X1200X950 mm



**FE-602**



**FE-603**

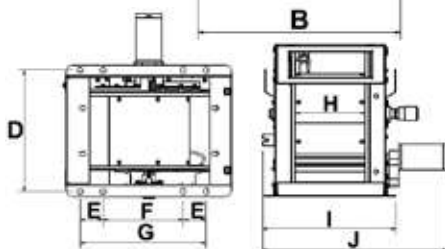
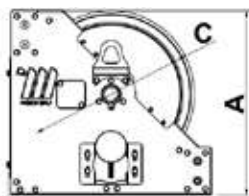

# INDUSTRIAL HOSE REELS IN PAINTED STEEL MOTORIZED 24V ELECTRIC SERIES Mod. FE-600

## For air-water and diesel 20 bar

Equipped with:

- Brass swivelling joint - Viton® seals
- **Electric 24V DC motor** 448W power

Article	Model	Internal reel width	Inlet-Outlet
076-6122-600	FE-601	330 mm	F1" - F1" BSP
076-6222-600	FE-602	440 mm	F1" - F1" BSP
076-6322-600	FE-603	550 mm	F1" - F1" BSP



FE-601

## For water 150° C 200 bar

Equipped with:

- AISI 304 stainless steel 90° swivelling joint - Viton® seals
- **Electric 24V DC motor** 448W power

Article	Model	Internal reel width	Inlet-Outlet
076-6125-600	FE-601	330 mm	F1" - F1" BSP
076-6225-600	FE-602	440 mm	F1" - F1" BSP
076-6325-600	FE-603	550 mm	F1" - F1" BSP



FE-602

## For oil and lubricants 250 bar

Equipped with:

- Galvanized steel swivelling joint - NBR seals
- **Electric 24V DC motor** 448W power

Article	Model	Internal reel width	Inlet-Outlet
076-6126-600	FE-601	330 mm	F1" - F1" BSP
076-6226-600	FE-602	440 mm	F1" - F1" BSP
076-6326-600	FE-603	550 mm	F1" - F1" BSP



FE-603

## For grease 300 bar

Equipped with:

- Galvanized steel swivelling joint - NBR seals
- **Electric 24V DC motor** 448W power

Article	Model	Internal reel width	Inlet-Outlet
076-6127-600	FE-601	330 mm	F1" - F1" BSP
076-6227-600	FE-602	440 mm	F1" - F1" BSP
076-6327-600	FE-603	550 mm	F1" - F1" BSP

## Hose reel capacity

Ø Hose	Ø external Hose	Mod.FE-601	Mod.FE-602	Mod.FE-603
1/2"	20 mm	50 m	100 m	200 m
3/4"	27 mm	30 m	60 m	90 m
1"	34 mm	20 m	40 m	60 m

## Overall dimensions

Model	A	B	C	D	E	F	G	H	I	J	Weight	Packaging
FE-601	660	733	600	530	100	350	550	330	580	810	114 kg	800X1200X950 mm
FE-602	660	733	600	640	100	350	550	440	690	920	119 kg	800X1200X950 mm
FE-603	660	733	600	750	100	350	550	550	800	1030	124 kg	800X1200X950 mm

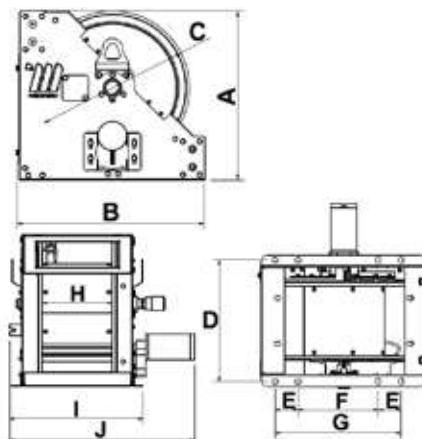

# INDUSTRIAL HOSE REELS IN PAINTED STEEL MOTORIZED 230V ELECTRIC SERIES Mod. FE-600



**FE-601**

## For air-water and diesel 20 bar

Equipped with:

- Brass swivelling joint - Viton® seals
- **Electric 230V AC motor** 402W power

Article	Model	Internal reel width	Inlet-Outlet
<b>076-6132-600</b>	<b>FE-601</b>	330 mm	F1" - F1" BSP
<b>076-6232-600</b>	<b>FE-602</b>	440 mm	F1" - F1" BSP
<b>076-6332-600</b>	<b>FE-603</b>	550 mm	F1" - F1" BSP

## For water 150° C 200 bar

Equipped with:

- AISI 304 stainless steel 90° swivelling joint - Viton® seals
- **Electric 230 AC motor** 402W power

Article	Model	Internal reel width	Inlet-Outlet
<b>076-6135-600</b>	<b>FE-601</b>	330 mm	F1" - F1" BSP
<b>076-6235-600</b>	<b>FE-602</b>	440 mm	F1" - F1" BSP
<b>076-6335-600</b>	<b>FE-603</b>	550 mm	F1" - F1" BSP

## For oil and lubricants 250 bar

Equipped with:

- Galvanized steel swivelling joint - NBR seals
- **Electric 230V AC motor** 402W power

Article	Model	Internal reel width	Inlet-Outlet
<b>076-6136-600</b>	<b>FE-601</b>	330 mm	F1" - F1" BSP
<b>076-6236-600</b>	<b>FE-602</b>	440 mm	F1" - F1" BSP
<b>076-6336-600</b>	<b>FE-603</b>	550 mm	F1" - F1" BSP

## For grease 300 bar

Equipped with:

- Galvanized steel swivelling joint - NBR seals
- **Electric 230V AC motor** 402W power

Article	Model	Internal reel width	Inlet-Outlet
<b>076-6137-600</b>	<b>FE-601</b>	330 mm	F1" - F1" BSP
<b>076-6237-600</b>	<b>FE-602</b>	440 mm	F1" - F1" BSP
<b>076-6337-600</b>	<b>FE-603</b>	550 mm	F1" - F1" BSP

## Hose reel capacity

Ø Hose	Ø external Hose	Mod.FE-601	Mod.FE-602	Mod.FE-603
<b>1/2"</b>	20 mm	<b>50 m</b>	<b>100 m</b>	<b>200 m</b>
<b>3/4"</b>	27 mm	<b>30 m</b>	<b>60 m</b>	<b>90 m</b>
<b>1"</b>	34 mm	<b>20 m</b>	<b>40 m</b>	<b>60 m</b>

## Overall dimensions

Model	A	B	C	D	E	F	G	H	I	J	Weight	Packaging
<b>FE-601</b>	660	733	600	530	100	350	550	330	580	810	114 kg	800X1200X950 mm
<b>FE-602</b>	660	733	600	640	100	350	550	440	690	920	119 kg	800X1200X950 mm
<b>FE-603</b>	660	733	600	750	100	350	550	550	800	1030	124 kg	800X1200X950 mm



**FE-602**



**FE-603**

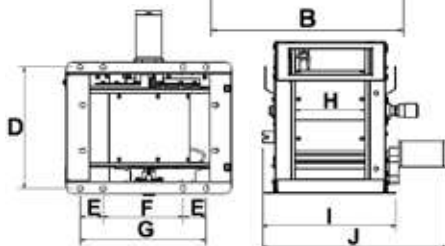
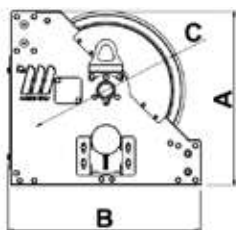

# INDUSTRIAL HOSE REELS IN PAINTED STEEL MOTORIZED 115V ELECTRIC SERIES Mod. FE-600

## For air-water and diesel 20 bar

Equipped with:

- Brass swivelling joint - Viton® seals
- **Electric 115V AC motor** potenza 441W power

Article	Model	Internal reel width	Inlet-Outlet
076-6152-600	FE-601	330 mm	F1"- F1" BSP
076-6252-600	FE-602	440 mm	F1"- F1" BSP
076-6352-600	FE-603	550 mm	F1"- F1" BSP



FE-601

## For water 150° C 200 bar

Equipped with:

- AISI 304 stainless steel 90° swivelling joint - Viton® seals
- **Electric 115V AC motor** 441W power

Article	Model	Internal reel width	Inlet-Outlet
076-6155-600	FE-601	330 mm	F1"- F1" BSP
076-6255-600	FE-602	440 mm	F1"- F1" BSP
076-6355-600	FE-603	550 mm	F1"- F1" BSP



FE-602

## For oil and lubricants 250 bar

Equipped with:

- Galvanized steel swivelling joint - NBR seals
- **Electric 115V AC motor** 441W power

Article	Model	Internal reel width	Inlet-Outlet
076-6156-600	FE-601	330 mm	F1"- F1" BSP
076-6256-600	FE-602	440 mm	F1"- F1" BSP
076-6356-600	FE-603	550 mm	F1"- F1" BSP



FE-603

## For grease 300 bar

Equipped with:

- Galvanized steel swivelling joint - NBR seals
- **Electric 115V AC motor** potenza 441W power

Article	Model	Internal reel width	Inlet-Outlet
076-6157-600	FE-601	330 mm	F1"- F1" BSP
076-6257-600	FE-602	440 mm	F1"- F1" BSP
076-6357-600	FE-603	550 mm	F1"- F1" BSP

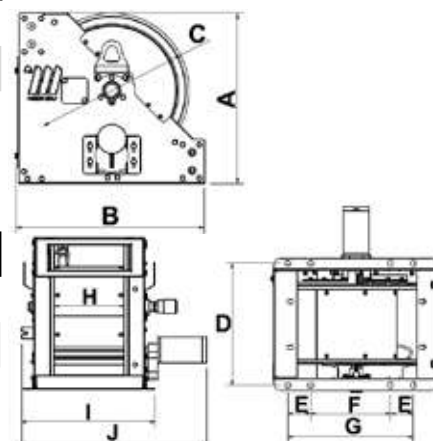

## Hose reel capacity

Ø Hose	Ø external Hose	Mod.FE-601	Mod.FE-602	Mod.FE-603
1/2"	20 mm	50 m	100 m	200 m
3/4"	27 mm	30 m	60 m	90 m
1"	34 mm	20 m	40 m	60 m

## Overall dimensions

Model	A	B	C	D	E	F	G	H	I	J	Weight	Packaging
FE-601	660	733	600	530	100	350	550	330	580	810	114 kg	800X1200X950 mm
FE-602	660	733	600	640	100	350	550	440	690	920	119 kg	800X1200X950 mm
FE-603	660	733	600	750	100	350	550	550	800	1030	124 kg	800X1200X950 mm

# INDUSTRIAL HOSE REELS IN PAINTED STEEL MOTORIZED HYDRAULIC SERIES Mod. FI-600



FI-601

## For air-water and diesel 20 bar

Equipped with:

- Brass swivelling joint - Viton® seals
- Hydraulic motor

Article	Model	Internal reel width	Inlet-Outlet
076-6162-600	FI-601	330 mm	F1"- F1" BSP
076-6262-600	FI-602	440 mm	F1"- F1" BSP
076-6362-600	FI-603	550 mm	F1"- F1" BSP



FI-602

## For water 150° C 200 bar

Equipped with:

- AISI 304 stainless steel 90° swivelling joint - Viton® seals
- Hydraulic motor

Article	Model	Internal reel width	Inlet-Outlet
076-6165-600	FI-601	330 mm	F1"- F1" BSP
076-6265-600	FI-602	440 mm	F1"- F1" BSP
076-6365-600	FI-603	550 mm	F1"- F1" BSP

## For oil and lubricants 250 bar

Equipped with:

- Galvanized steel swivelling joint - NBR seals
- Hydraulic motor

Article	Model	Internal reel width	Inlet-Outlet
076-6166-600	FI-601	330 mm	F1"- F1" BSP
076-6266-600	FI-602	440 mm	F1"- F1" BSP
076-6366-600	FI-603	550 mm	F1"- F1" BSP



FI-603

## For grease 300 bar

Equipped with:

- Galvanized steel swivelling joint - NBR seals
- Hydraulic motor

Article	Model	Internal reel width	Inlet-Outlet
076-6167-600	FI-601	330 mm	F1"- F1" BSP
076-6267-600	FI-602	440 mm	F1"- F1" BSP
076-6367-600	FI-603	550 mm	F1"- F1" BSP

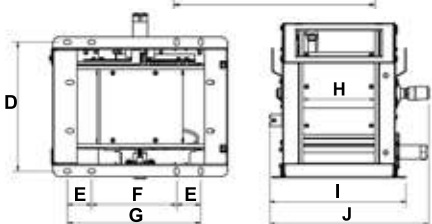
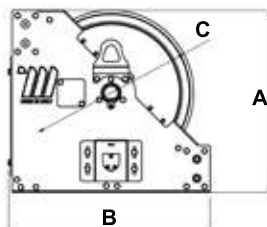

## Hose reel capacity

Ø Hose	Ø external Hose	Mod.FI-601	Mod.FI-602	Mod.FI-603
1/2"	20 mm	50 m	100 m	200 m
3/4"	27 mm	30 m	60 m	90 m
1"	34 mm	20 m	40 m	60 m

## Overall dimensions

Model	A	B	C	D	E	F	G	H	I	J	Weight	Packaging
FI-601	660	733	600	530	100	350	550	330	580	680	109 kg	800X1200X950 mm
FI-602	660	733	600	640	100	350	550	440	690	790	113 kg	800X1200X950 mm
FI-603	660	733	600	750	100	350	550	550	800	900	118 kg	800X1200X950 mm

# INDUSTRIAL HOSE REELS IN PAINTED STEEL MOTORIZED PNEUMATIC SERIES Mod. FP-600

## For air-water and diesel 20 bar

Equipped with:

- Brass swivelling joint - Viton® seals
- Pneumatic motor

Article	Model	Internal reel width	Inlet-Outlet
076-6172-600	FP-601	330 mm	F1" - F1" BSP
076-6272-600	FP-602	440 mm	F1" - F1" BSP
076-6372-600	FP-603	550 mm	F1" - F1" BSP



FP-601

## For water 150° C 200 bar

Equipped with:

- AISI 304 stainless steel 90° swivelling joint - Viton® seals
- Pneumatic motor

Article	Model	Internal reel width	Inlet-Outlet
076-6175-600	FP-601	330 mm	F1" - F1" BSP
076-6275-600	FP-602	440 mm	F1" - F1" BSP
076-6375-600	FP-603	550 mm	F1" - F1" BSP



FP-602

## For oil and lubricants 250 bar

Equipped with:

- Galvanized steel swivelling joint - NBR seals
- Pneumatic motor

Article	Model	Internal reel width	Inlet-Outlet
076-6176-600	FP-601	330 mm	F1" - F1" BSP
076-6276-600	FP-602	440 mm	F1" - F1" BSP
076-6376-600	FP-603	550 mm	F1" - F1" BSP



FP-603

## For grease 300 bar

Equipped with:

- Galvanized steel swivelling joint - NBR seals
- Pneumatic motor

Article	Model	Internal reel width	Inlet-Outlet
076-6177-600	FP-601	330 mm	F1" - F1" BSP
076-6277-600	FP-602	440 mm	F1" - F1" BSP
076-6377-600	FP-603	550 mm	F1" - F1" BSP

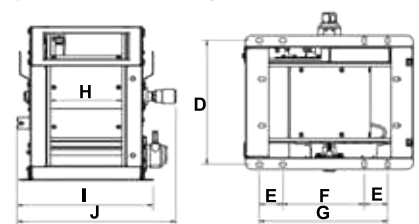
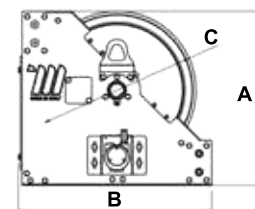

## Hose reel capacity

Ø Hose	Ø external Hose	Mod.FI-601	Mod.FI-602	Mod.FI-603
1/2"	20 mm	50 m	100 m	200 m
3/4"	27 mm	30 m	60 m	90 m
1"	34 mm	20 m	40 m	60 m

## Overall dimensions

Model	A	B	C	D	E	F	G	H	I	J	Weight	Packaging
FP-601	660	733	600	530	100	350	550	330	580	680	110 kg	800X1200X950 mm
FP-602	660	733	600	640	100	350	550	440	690	790	115 kg	800X1200X950 mm
FP-603	660	733	600	750	100	350	550	550	800	900	119 kg	800X1200X950 mm

# INDUSTRIAL HOSE REELS IN PAINTED STEEL MANUAL SERIES Mod. FM-600



**FM-601**

## For air-water and diesel 20 bar

Equipped with:

- Brass swivelling joint - Viton® seals
- Manual with crank

Article	Model	Internal reel width	Inlet-Outlet
076-6192-600	FM-601	330 mm	F1" - F1" BSP
076-6292-600	FM-602	440 mm	F1" - F1" BSP
076-6392-600	FM-603	550 mm	F1" - F1" BSP



**FM-602**

## For water 150° C 200 bar

Equipped with:

- AISI 304 stainless steel 90° swivelling joint - Viton® seals
- Manual with crank

Article	Model	Internal reel width	Inlet-Outlet
076-6195-600	FM-601	330 mm	F1" - F1" BSP
076-6295-600	FM-602	440 mm	F1" - F1" BSP
076-6395-600	FM-603	550 mm	F1" - F1" BSP



**FM-603**

## For oil and lubricants 250 bar

Equipped with:

- Galvanized steel swivelling joint - NBR seals
- Manual with crank

Article	Model	Internal reel width	Inlet-Outlet
076-6196-600	FM-601	330 mm	F1" - F1" BSP
076-6296-600	FM-602	440 mm	F1" - F1" BSP
076-6396-600	FM-603	550 mm	F1" - F1" BSP

## For grease 300 bar

Equipped with:

- Galvanized steel swivelling joint - NBR seals
- Manual with crank

Article	Model	Internal reel width	Inlet-Outlet
076-6197-600	FM-601	330 mm	F1" - F1" BSP
076-6297-600	FM-602	440 mm	F1" - F1" BSP
076-6397-600	FM-603	550 mm	F1" - F1" BSP

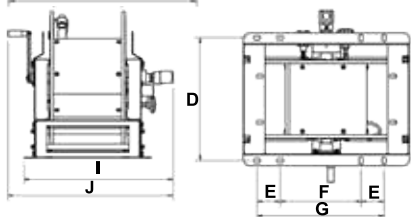
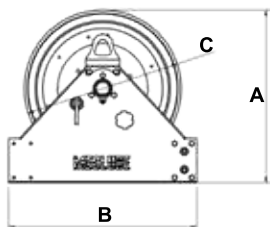

## Hose reel capacity

Ø Hose	Ø external Hose	Mod.FM-601	Mod.FM-602	Mod.FM-603
1/2"	20 mm	50 m	100 m	200 m
3/4"	27 mm	30 m	60 m	90 m
1"	34 mm	20 m	40 m	60 m

## Overall dimensions

Model	A	B	C	D	E	F	G	H	I	J	Weight	Packaging
FM-601	660	720	600	530	100	350	550	330	670	745	83 kg	800X1200X950 mm
FM-602	660	720	600	640	100	350	550	440	780	855	87 kg	800X1200X950 mm
FM-603	660	720	600	750	100	350	550	550	890	965	91 kg	800X1200X950 mm

# TECHNICAL DATA FOR ELECTRIC, HYDRAULIC, PNEUMATIC MOTORIZATION

## Art. 076-9500-012

Electric gear motor 12V DC with pinion and fixing bracket  
Motor protection rating IP55



## Art. 076-9500-024

Electric gear motor 24V DC with pinion and fixing bracket  
Motor protection rating IP55



## Art. 076-9500-115

Electric gear motor 115V AC with pinion and fixing bracket  
Motor protection rating IP55



## Art. 076-9500-230

Electric gear motor 230V AC with pinion and fixing bracket  
Motor protection rating IP55



## Art. 076-9610-032

Hydraulic motor OM 32 C-S with pinion and fixing bracket



## Art. 076-9620-250

Pneumatic motor M 250F with pinion and fixing bracket



### Technical data

Article	Voltage	Power	RPM	Duty cycle	Absorbed power	Weight	Packaging
076-9500-012	12V DC	430W	305 RPM	S3 - 50%	A 36	10,000 kg	300X200X200 mm
076-9500-024	24V DC	448W	308 RPM	S3 - 50%	A 19	10,000 kg	300X200X200 mm
076-9500-115	115V AC	441W	308 RPM	S3 - 50%	A 3,84	10,000 kg	300X200X200 mm
076-9500-230	230V AC	402W	305 RPM	S3 - 50%	A 1,75	10,000 kg	300X200X200 mm
076-9610-032	-	-	830 RPM	-	-	4,000 kg	200X150X150 mm
076-9620-250	-	-	850 RPM	-	-	5,40ww0 kg	200X150X150 mm

# INDUSTRIAL HOSE REELS Mod. 700

The motorized industrial hose reels are designed for applications that require robust equipment, also on trucks. They are suitable for flexible hoses with big diameters for the distribution of compressed air, water, oil and similar, grease, diesel.

## - MOTORIZED 12-24V DC ELECTRIC

**The unwinding of the hose is manual while the rolling process is through the electric motor (12-24V DC).**

It can be connected to a battery or to a power transformer connected to the 230V network.



## - MOTORIZED 230-115V AC ELECTRIC

**The unwinding of the hose is manual while the rolling process is through the electric motor (230-115 AC).**

It has to be connected to the 230-115V AC electric network.



## - MOTORIZED HYDRAULIC

**The unwinding of the hose is manual while the rolling process is through the hydraulic motor.**

It has to be connected to a specific control unit equipped with electric motor, hydraulic oil tank and to a command-and-control system with lever for the rolling process.



## - MOTORIZED PNEUMATIC

**The unwinding of the hose is manual while the rolling process is through the pneumatic motor. It has to be connected to the compressed air supply and to a pressure regulator that allows to adjust the rolling power and speed.**

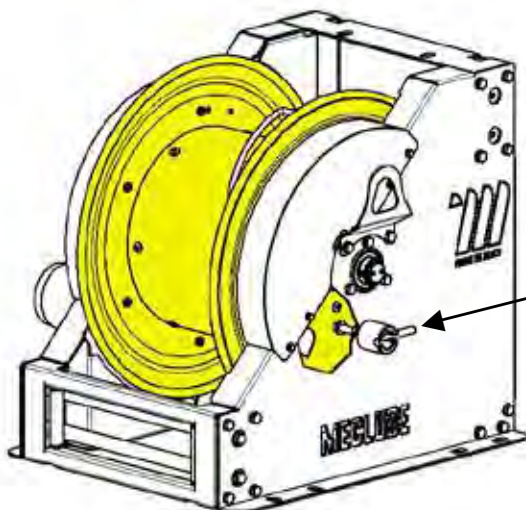

Blocking lever

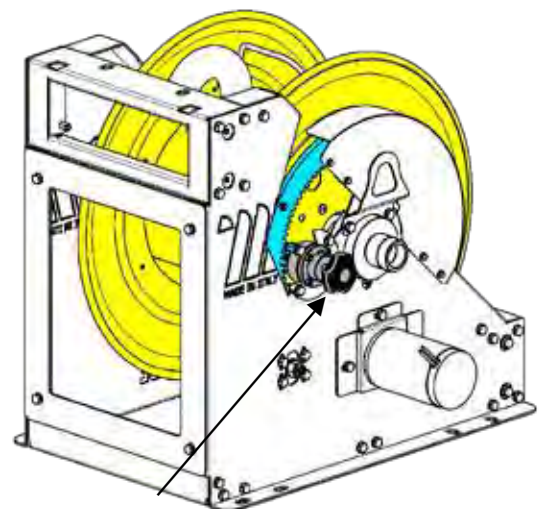

Clutch to regulate the hose unwinding and to avoid the reel to rotate loosely by inertia.

# INDUSTRIAL HOSE REELS Mod. 700

New series of motorized industrial hose reels Mod.700

They are supplied with reel  $\varnothing$  700 with 3 different widths: 330, 440, 550 mm

2" F swivelling joint with pressures of 20 and 250 bar. The main difference is the type of motorization:

- Electric 12V - 24V - 230V - 115V
- Hydraulic
- Pneumatic

They are designed for applications that require robust equipment, also on trucks.

They are suitable for flexible hoses with maximum  $\varnothing$  of 2", for the distribution of compressed air, oil and similar, diesel.

**They are designed to have two different hose exit positions, an upper and a lower one.**



Motorized chain transmission with double sprocket

# INDUSTRIAL HOSE REELS IN PAINTED STEEL MOTORIZED 12V ELECTRIC SERIES Mod. FE-700



**FE-701**

## For air-water and diesel 20 bar

Equipped with:

- Anodized aluminium swivelling joint
- Viton® seals
- **Electric 12V DC motor** 449W power

Article	Model	Internal reel width	Inlet-Outlet
<b>076-7112-900</b>	<b>FE-701</b>	330 mm	F2"- F2" BSP
<b>076-7212-900</b>	<b>FE-702</b>	440 mm	F2"- F2" BSP
<b>076-7312-900</b>	<b>FE-703</b>	550 mm	F2"- F2" BSP



**FE-702**

## For oil and lubricants 250 bar

Equipped with:

- Galvanized steel swivelling joint
- NBR seals
- **Electric 12V DC motor** 449W power

Article	Model	Internal reel width	Inlet-Outlet
<b>076-7116-900</b>	<b>FE-701</b>	330 mm	F2"- F2" BSP
<b>076-7216-900</b>	<b>FE-702</b>	440 mm	F2"- F2" BSP
<b>076-7316-900</b>	<b>FE-703</b>	550 mm	F2"- F2" BSP



**FE-703**

## Hose reel capacity

Ø Hose	Ø external Hose	Mod.FE-701	Mod.FE-702	Mod.FE-703
<b>1.1/4"</b>	43 mm	<b>35 m</b>	<b>45 m</b>	<b>60 m</b>
<b>1.1/2"</b>	50 mm	<b>20 m</b>	<b>30 m</b>	<b>50 m</b>
<b>2"</b>	63 mm	<b>15 m</b>	<b>25 m</b>	<b>30 m</b>

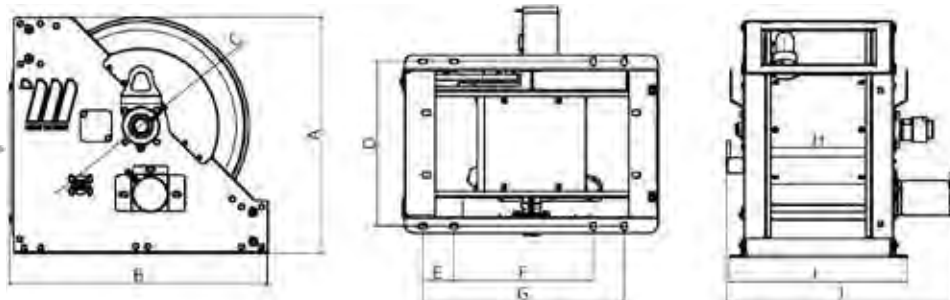

## Overall dimensions

Model	A	B	C	D	E	F	G	H	I	J	Weight	Packaging
<b>FE-701</b>	760	833	700	531	100	450	650	330	574	734	122 kg	800X1200X950 mm
<b>FE-702</b>	760	833	700	641	100	450	650	440	684	844	140 kg	1000X1200X950 mm
<b>FE-703</b>	760	833	700	751	100	450	650	550	794	954	155 kg	1000X1200X950 mm

The industrial hose reels with **electric motor 12V** are designed for applications that require robust equipment, also on trucks. They are suitable for flexible hoses with big diameters for the distribution of compressed air, oil and similar, diesel.

The unwinding of the hose is manual while the rolling process is through the electric motor. It can be connected to a battery or to a power transformer connected to the 230V network.

# INDUSTRIAL HOSE REELS IN PAINTED STEEL MOTORIZED 24V ELECTRIC SERIES Mod. FE-700

## For air-water and diesel 20 bar

Equipped with:

- Anodized aluminium swivelling joint
- Viton® seals
- **Electric 24V DC motor** 457W power

Article	Model	Internal reel width	Inlet-Outlet
076-7122-900	FE-701	330 mm	F2"- F2" BSP
076-7222-900	FE-702	440 mm	F2"- F2" BSP
076-7322-900	FE-703	550 mm	F2"- F2" BSP



FE-701

## For oil and lubricants 250 bar

Equipped with:

- Galvanized steel swivelling joint
- NBR seals
- **Electric 24V DC motor** 457W power

Article	Model	Internal reel width	Inlet-Outlet
076-7126-900	FE-701	330 mm	F2"- F2" BSP
076-7226-900	FE-702	440 mm	F2"- F2" BSP
076-7326-900	FE-703	550 mm	F2"- F2" BSP



FE-702

## Hose reel capacity

Ø Hose	Ø external Hose	Mod.FE-701	Mod.FE-702	Mod.FE-703
1.1/4"	43 mm	35 m	45 m	60 m
1.1/2"	50 mm	20 m	30 m	50 m
2"	63 mm	15 m	25 m	30 m



FE-703

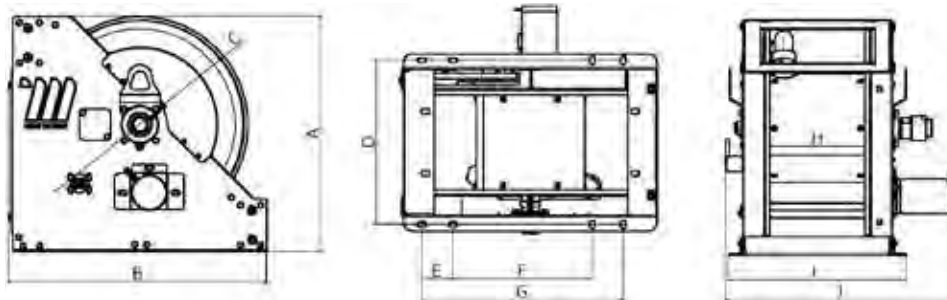

## Overall dimensions

Model	A	B	C	D	E	F	G	H	I	J	Weight	Packaging
FE-701	760	833	700	531	100	450	650	330	574	734	122 kg	800X1200X950 mm
FE-702	760	833	700	641	100	450	650	440	684	844	140 kg	1000X1200X950 mm
FE-703	760	833	700	751	100	450	650	550	794	954	155 kg	1000X1200X950 mm

The industrial hose reels with **electric motor 24V** are designed for applications that require robust equipment, also on trucks. They are suitable for flexible hoses with big diameters for the distribution of compressed air, oil and similar, diesel.

The unwinding of the hose is manual while the rolling process is through the electric motor. It can be connected to a battery or to a power transformer connected to the 230V network.

# INDUSTRIAL HOSE REELS IN PAINTED STEEL MOTORIZED 230V ELECTRIC SERIES Mod. FE-700



**FE-701**

## For air-water and diesel 20 bar

Equipped with:

- Anodized aluminium swivelling joint
- Viton® seals
- **Electric 230V AC motor** 448W power

Article	Model	Internal reel width	Inlet-Outlet
<b>076-7132-900</b>	<b>FE-701</b>	330 mm	F2"- F2" BSP
<b>076-7232-900</b>	<b>FE-702</b>	440 mm	F2"- F2" BSP
<b>076-7332-900</b>	<b>FE-703</b>	550 mm	F2"- F2" BSP



**FE-702**

## For oil and lubricants 250 bar

Equipped with:

- Galvanized steel swivelling joint
- NBR seals
- **Electric 230V AC motor** 448W power

Article	Model	Internal reel width	Inlet-Outlet
<b>076-7136-900</b>	<b>FE-701</b>	330 mm	F2"- F2" BSP
<b>076-7236-900</b>	<b>FE-702</b>	440 mm	F2"- F2" BSP
<b>076-7336-900</b>	<b>FE-703</b>	550 mm	F2"- F2" BSP

## Hose reel capacity

Ø Hose	Ø external Hose	Mod.FE-701	Mod.FE-702	Mod.FE-703
<b>1.1/4"</b>	43 mm	<b>35 m</b>	<b>45 m</b>	<b>60 m</b>
<b>1.1/2"</b>	50 mm	<b>20 m</b>	<b>30 m</b>	<b>50 m</b>
<b>2"</b>	63 mm	<b>15 m</b>	<b>25 m</b>	<b>30 m</b>



**FE-703**

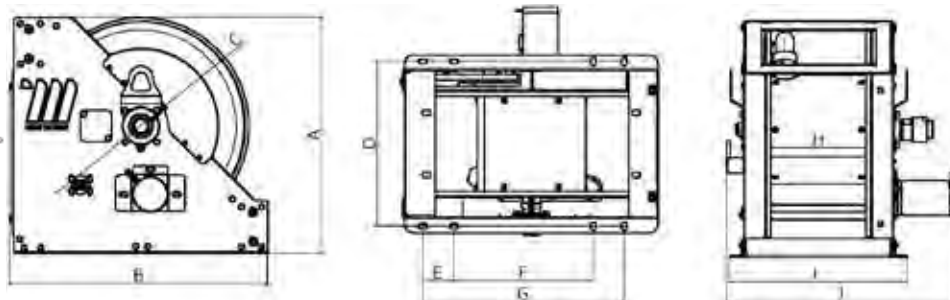

## Overall dimensions

Model	A	B	C	D	E	F	G	H	I	J	Weight	Packaging
<b>FE-701</b>	760	833	700	531	100	450	650	330	574	734	122 kg	800X1200X950 mm
<b>FE-702</b>	760	833	700	641	100	450	650	440	684	844	140 kg	1000X1200X950 mm
<b>FE-703</b>	760	833	700	751	100	450	650	550	794	954	155 kg	1000X1200X950 mm

The industrial hose reels with electric motor 230V are designed for applications that require robust equipment, also on trucks. They are suitable for flexible hoses with big diameters for the distribution of compressed air, oil and similar, diesel.

The unwinding of the hose is manual while the rolling process is through the electric motor (230 AC). It has to be connected to the 230 AC electric network.

# INDUSTRIAL HOSE REELS IN PAINTED STEEL MOTORIZED 115V ELECTRIC SERIES Mod. FE-700

## For air-water and diesel 20 bar

Equipped with:

- Anodized aluminium swivelling joint
- Viton® seals
- **Electric 115V AC motor** 451W power

Article	Model	Internal reel width	Inlet-Outlet
076-7152-900	FE-701	330 mm	F2"- F2" BSP
076-7252-900	FE-702	440 mm	F2"- F2" BSP
076-7352-900	FE-703	550 mm	F2"- F2" BSP



FE-701

## For oil and lubricants 250 bar

Equipped with:

- Anodized aluminium swivelling joint
- NBR seals
- **Electric 115V AC motor** 451W power

Article	Model	Internal reel width	Inlet-Outlet
076-7156-900	FE-701	330 mm	F2"- F2" BSP
076-7256-900	FE-702	440 mm	F2"- F2" BSP
076-7356-900	FE-703	550 mm	F2"- F2" BSP



FE-702

## Hose reel capacity

Ø Hose	Ø external Hose	Mod.FE-701	Mod.FE-702	Mod.FE-703
1.1/4"	43 mm	35 m	45 m	60 m
1.1/2"	50 mm	20 m	30 m	50 m
2"	63 mm	15 m	25 m	30 m



FE-703

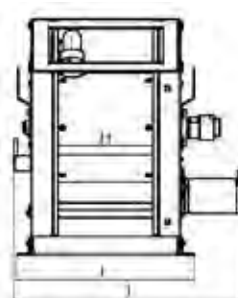
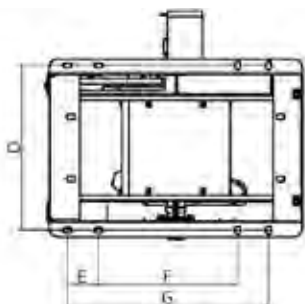
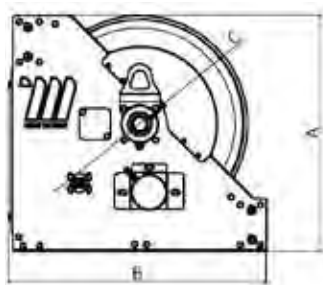

## Overall dimensions

Model	A	B	C	D	E	F	G	H	I	J	Weight	Packaging
FE-701	760	833	700	531	100	450	650	330	574	734	122 kg	800X1200X950 mm
FE-702	760	833	700	641	100	450	650	440	684	844	140 kg	1000X1200X950 mm
FE-703	760	833	700	751	100	450	650	550	794	954	155 kg	1000X1200X950 mm

The industrial hose reels with **electric motor 115V** are designed for applications that require robust equipment, also on trucks. They are suitable for flexible hoses with big diameters for the distribution of compressed air, oil and similar, diesel.

The unwinding of the hose is manual while the rolling process is through the electric motor (115 AC). It has to be connected to the 115V AC electric network.

# INDUSTRIAL HOSE REELS IN PAINTED STEEL MOTORIZED HYDRAULIC SERIES Mod. FI-700



**FI-701**

## For air-water and diesel 20 bar

Equipped with:

- Anodized aluminium swivelling joint
- Viton® seals
- **Hydraulic motor**

Article	Model	Internal reel width	Inlet-Outlet
<b>076-7162-900</b>	<b>FI-701</b>	330 mm	F2"- F2" BSP
<b>076-7262-900</b>	<b>FI-702</b>	440 mm	F2"- F2" BSP
<b>076-7362-900</b>	<b>FI-703</b>	550 mm	F2"- F2" BSP



**FI-702**

## For oil and lubricants 250 bar

Equipped with:

- Galvanized steel swivelling joint
- NBR seals
- **Hydraulic motor**

Article	Model	Internal reel width	Inlet-Outlet
<b>076-7166-900</b>	<b>FI-701</b>	330 mm	F2"- F2" BSP
<b>076-7266-900</b>	<b>FI-702</b>	440 mm	F2"- F2" BSP
<b>076-7366-900</b>	<b>FI-703</b>	550 mm	F2"- F2" BSP



**FI-703**

## Hose reel capacity

Ø Hose	Ø external Hose	Mod.FI-701	Mod.FI-702	Mod.FI-703
<b>1.1/4"</b>	43 mm	<b>35 m</b>	<b>45 m</b>	<b>60 m</b>
<b>1.1/2"</b>	50 mm	<b>20 m</b>	<b>30 m</b>	<b>50 m</b>
<b>2"</b>	63 mm	<b>15 m</b>	<b>25 m</b>	<b>30 m</b>

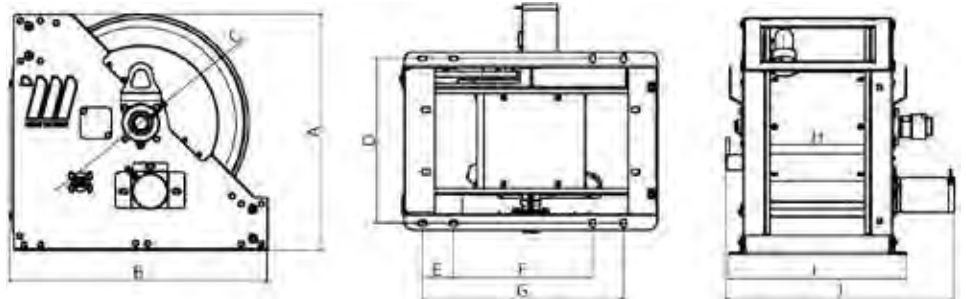

## Overall dimensions

Model	A	B	C	D	E	F	G	H	I	J	Weight	Packaging
<b>FI-701</b>	760	833	700	531	100	450	650	330	574	734	119 kg	800X1200X950 mm
<b>FI-702</b>	760	833	700	641	100	450	650	440	684	844	137 kg	1000X1200X950 mm
<b>FI-703</b>	760	833	700	751	100	450	650	550	794	954	152 kg	1000X1200X950 mm

The industrial hose reels with **hydraulic motor** are designed for applications that require robust equipment, also on trucks. They are suitable for flexible hoses with big diameters for the distribution of compressed air, oil and similar, diesel. The unwinding of the hose is manual while the rolling process is through the hydraulic motor. It has to be connected to a specific control unit equipped with electric motor, hydraulic oil tank and to a command-and-control system with lever for the rolling process.

# INDUSTRIAL HOSE REELS IN PAINTED STEEL MOTORIZED PNEUMATIC SERIES Mod. FP-700

## For air-water and diesel 20 bar

Equipped with:

- Anodized aluminium swivelling joint
- Viton® seals
- **Pneumatic motor**

Article	Model	Internal reel width	Inlet-Outlet
076-7172-900	FP-701	330 mm	F2"- F2" BSP
076-7272-900	FP-702	440 mm	F2"- F2" BSP
076-7372-900	FP-703	550 mm	F2"- F2" BSP



FP-701

## For oil and lubricants 250 bar

Equipped with:

- Galvanized steel swivelling joint
- NBR seals
- **Pneumatic motor**

Article	Model	Internal reel width	Inlet-Outlet
076-7176-900	FP-701	330 mm	F2"- F2" BSP
076-7276-900	FP-702	440 mm	F2"- F2" BSP
076-7376-900	FP-703	550 mm	F2"- F2" BSP



FP-702

## Hose reel capacity

Ø Hose	Ø external Hose	Mod.FE-701	Mod.FE-702	Mod.FE-703
1.1/4"	43 mm	35 m	45 m	60 m
1.1/2"	50 mm	20 m	30 m	50 m
2"	63 mm	15 m	25 m	30 m



FP-703

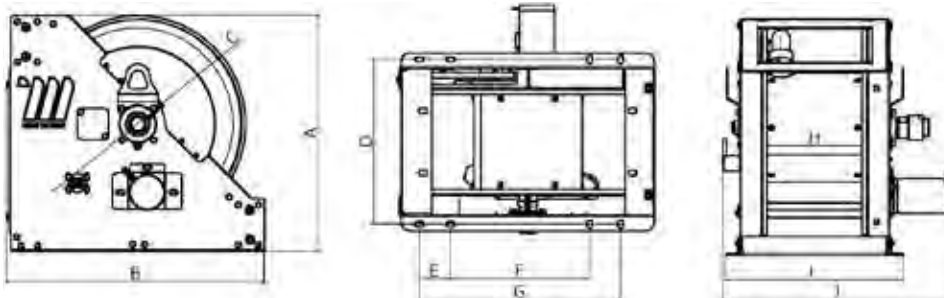

## Overall dimensions

Model	A	B	C	D	E	F	G	H	I	J	Weight	Packaging
FP-701	760	833	700	531	100	450	650	330	574	734	120 kg	800X1200X950 mm
FP-702	760	833	700	641	100	450	650	440	684	844	139 kg	1000X1200X950 mm
FP-703	760	833	700	751	100	450	650	550	794	954	155 kg	1000X1200X950 mm

The industrial hose reels with **pneumatic motor** are designed for applications that require robust equipment, also on trucks. They are suitable for flexible hoses with big diameters for the distribution of compressed air, oil and similar, diesel. The unwinding of the hose is manual while the rolling process is through the pneumatic motor. It has to be connected to the compressed air supply and to a pressure regulator that allows to adjust the rolling power and speed.

# TECHNICAL DATA FOR ELECTRIC, HYDRAULIC, PNEUMATIC MOTORIZATION



**Art. 076-9900-012**  
Electric motor 12V DC with pinion and fixing bracket  
Motor protection rating IP55



**Art. 076-9900-024**  
Electric motor 24V DC with pinion and fixing bracket  
Motor protection rating IP55



**Art. 076-9900-115**  
Electric motor 115V AC with pinion and fixing bracket  
Motor protection rating IP55



**Art. 076-9900-230**  
Electric motor 230V AC with pinion and fixing bracket  
Motor protection rating IP55



**Art. 076-9910-032**  
Hydraulic motor OM 32 C-S with pinion and fixing bracket



**Art. 076-9920-250**  
Pneumatic motor M 250F with pinion and fixing bracket



**Art. 076-9950-000**  
Adjustable rewinding clutch for hose reel Mod. 700  
with fixing bracket



**Art. 076-9960-000**  
Blocking lever for hose reel Mod.600/700

## Technical data

Article	Voltage	Power	RPM	Duty cycle	Absorbed power	Weight	Packaging
<b>076-9900-012</b>	<b>12V DC</b>	449W	810 RPM	S3 - 50%	A 37,5	7,700 kg	300X200X200 mm
<b>076-9900-024</b>	<b>24V DC</b>	457W	856 RPM	S3 - 50%	A 19	7,700 kg	300X200X200 mm
<b>076-9900-115</b>	<b>115V AC</b>	451W	869 RPM	S3 - 50%	A 4	7,700 kg	300X200X200 mm
<b>076-9900-230</b>	<b>230V AC</b>	448W	818 RPM	S3 - 50%	A 2	7,700 kg	300X200X200 mm
<b>076-9910-032</b>	-	-	830 RPM	-	-	3,500 kg	200X150X150 mm
<b>076-9920-250</b>	-	-	850 RPM	-	-	5,000 kg	200X150X150 mm

# HOSE REEL INSTALLATION

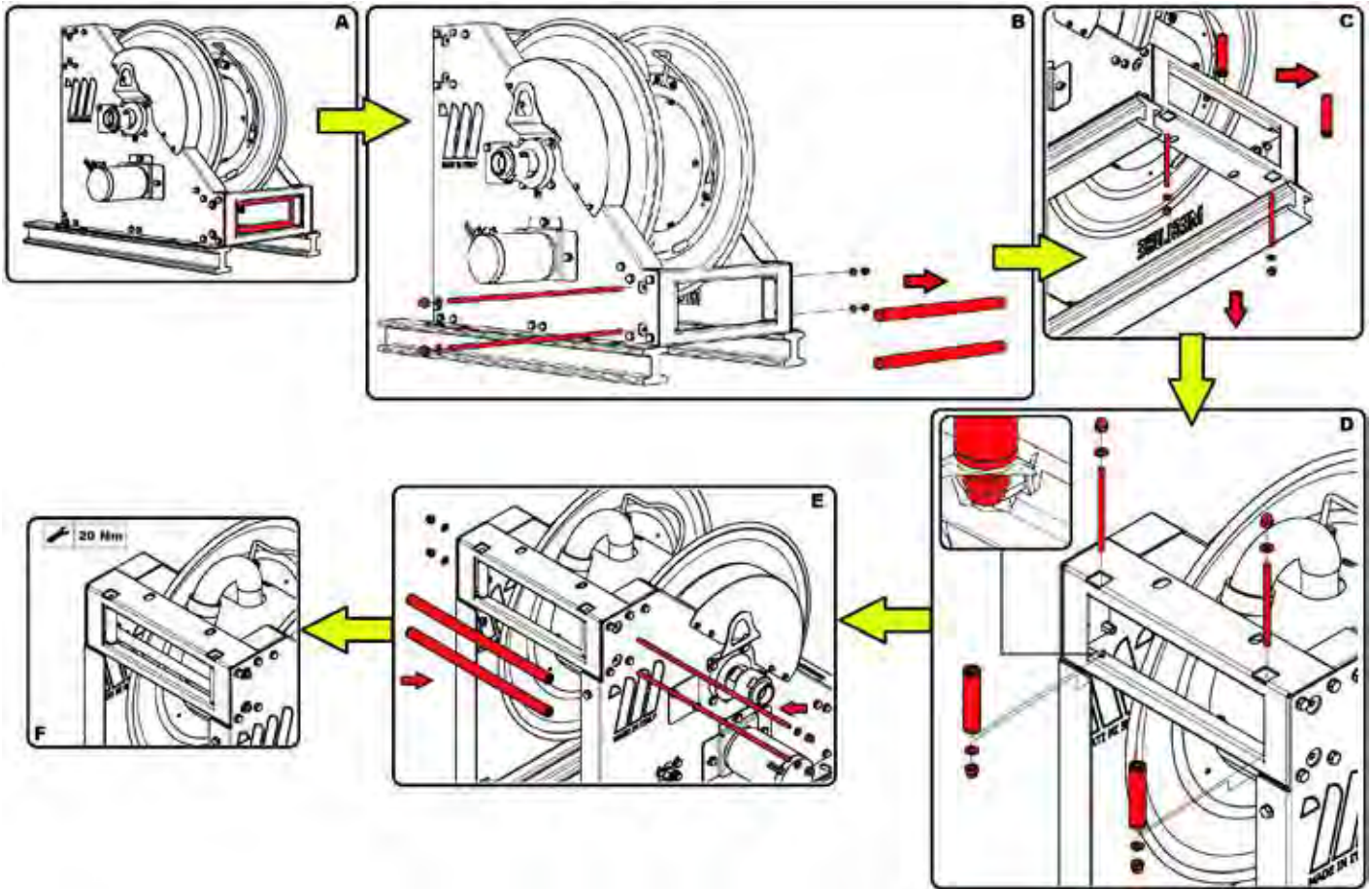

## HOSE REEL INSTALLATION

As a matter of fact before installing the hose reel it is important to decide which of the two hose exit positions is the best one for your purpose.

The hose reel is designed to have two different hose exit positions, an upper and a lower one. The machine is supplied with the rollers installed in the lower position, to put them in the upper position it is necessary to:

- A.** Lift the hose reel with a suitable equipment, make sure it is well secured, then set it on a base who let a free access to the lower part of the machine, without being instable and strong enough to support the reel weight.
- B.** Remove the 17 mm lateral nuts with the relative washer. Pull out the two support rods of the horizontal rollers, then remove them from the frame and put them on the bench.
- C.** Using a 17 mm wrench in the lower part of the reel you can now remove the locking nut of the vertical rollers, by loosening the rods and removing them from the base you can remove the short rollers from the frame.
- D.** Now go to the back upper section of the reel, insert the shorter rollers into the frame and fix them with the rods and nuts removed in the last step. We recommend the use of thread locker medium strength.
- E.** Repeat the operation on the longer rollers, insert the support rods and then fasten the 17 mm nuts with the washers. Also in this case it is firmly recommended the use of the thread locker medium strength.
- F.** Check the nuts tighten, the reference torque is 20 N/m

# PANELS SUPPORT HOSE REELS



079-1779-002

## Art. 079-1779-002

Panel support for 2 hose reels

For the application hose reels

Mod. F-400 – F-460 – F-550 – CF-500

Dimensions 590X390X65 mm



079-1779-002

6,700

0,216

1



079-1779-003

## Art. 079-1779-003

Panel support for 3 hose reels

For the application hose reels

Mod. F-400 – F-460 – F-550 – CF-500

Dimensions 860X390X65 mm



079-1779-003

9,200

0,313

1



079-1779-004

## Art. 079-1779-004

Panel support for 4 hose reels

For the application hose reels

Mod. F-400 – F-460 – F-550 – CF-500

Dimensions 1113X390X65 mm



079-1779-004

14,600

0,400

1



079-1779-005

## Art. 079-1779-005

Panel support for 5 hose reels

For the application hose reels

Mod. F-400 – F-460 – F-550 – CF-500

Dimensions 1460X390X65 mm



079-1779-005

15,900

0,500

1



079-1800-001

## Art. 079-1800-001

Bracket to be fixed to the ceiling on HEA girders

For the application of 1 hose reel

Mod. F-400-F-460-CF-500

Dimensions 425X192X26 mm



079-1800-001

2,350

0,048

1



079-1800-002

## Art. 079-1800-002

Bracket to be fixed to the ceiling on HEA girders

For the application of 2 hose reel

Mod. F-400-F-460-CF-500

Dimensions 428X205X26 mm



079-1800-002

5,500

0,050

1



079-1800-003

## Art. 079-1800-003

Bracket to be fixed to the ceiling on HEA girders

For the application of 3 hose reel

Mod. F-400-F-460-CF-500

Dimensions 698X205X26 mm



079-1800-003

7,400

0,080

1

These special brackets can be used in two different positions with 90° rotation



# ROTARY SUPPORT WITH QUICK CONNECTION FOR HOSE REELS

## Art. 079-1777-150

Rotary varnished support

For fixed hose reels Mod. F-400 – F460 – CF-500

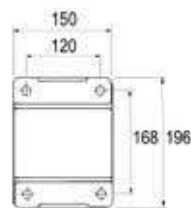

F-400/460  
FX-400/460



079-1777-150



079-1778-150

## Art. 079-1778-150

Rotary bracket in AISI 304 stainless steel

For fixed hose reels Mod. FX-400 – FX-460 – CFX-500

## Art. 079-1777-200

Rotary varnished support

For fixed hose reels Mod. F-550

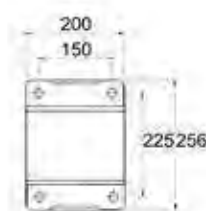

F-550  
FX-550



079-1777-200



079-1778-200

## Art. 079-1778-200

Rotary bracket in AISI 304 stainless steel

For fixed hose reels Mod. FX-550

## Art. 079-1777-250

Rotary varnished support

For fixed hose reels Mod. F-555



F-555  
FX-555



079-1777-250



079-1778-250

## Art. 079-1778-250

Rotary bracket in AISI 304 stainless steel

For fixed hose reels Mod. FX-555

## Art. 079-1776-000

Fixed varnished double bracket

For closed hose reels Mod. CF-500

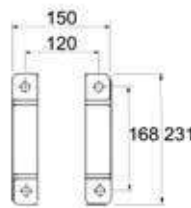

CF-300/500  
CFX-500



079-1776-000



079-1775-000

## Art. 079-1775-000

Double fixed bracket in AISI 304 stainless steel

For closed hose reels Mod. CFX-500

## Art. 024-1785-000

Support for drops collections for oil nozzle

Composed by:

Hook for stop oil nozzle

Removable drip tray

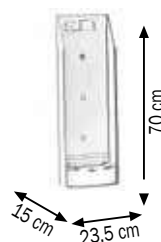

024-1785-000



024-1785-000 3,400 0,030 1

## DIRECTIONAL BRACKETS WITH HOSE GUIDE CRANK HANDLES FOR MANUAL HOSE REELS



### **Art. 079-1890-400**

Painted steel directional brackets with hose guide  
For manual hose reels Mod. FM-400/460

### **Art. 079-1890-550**

Painted steel directional brackets with hose guide  
For manual hose reels Mod. FM-550

### **Art. 079-1890-555**

Painted steel directional brackets with hose guide  
For manual hose reels Mod. FM-555

### **Art. 079-1890-560**

Painted steel directional brackets with hose guide  
For manual hose reels Mod. FM-560



### **Art. 079-1891-400**

AISI 304 stainless steel directional brackets with hose guide  
For manual hose reels Mod. FMX-400/460

### **Art. 079-1891-550**

AISI 304 stainless steel directional brackets with hose guide  
For manual hose reels Mod. FMX-550

### **Art. 079-1891-555**

AISI 304 stainless steel directional brackets with hose guide  
For manual hose reels Mod. FMX-555

### **Art. 079-1891-560**

AISI 304 stainless steel directional brackets with hose guide  
For manual hose reels Mod. FMX-560



### **Art. 077-9990-400**

Painted steel revolving flick with folding handgrip  
For manual hose reels Mod. FM-400/460

### **Art. 077-9990-550**

Painted steel revolving flick with folding handgrip  
For manual hose reels Mod. FM-550/555/560



### **Art. 077-9991-400**

AISI 304 stainless steel revolving flick with folding handgrip  
For manual hose reels Mod. FM-400/460

### **Art. 077-9991-550**

AISI 304 stainless steel revolving flick with folding handgrip  
For manual hose reels Mod. FM-550/555/560



### **Art. 076-9990-600**

Painted steel revolving flick  
For manual industrial hose reels Mod. FM-600

# SWIVELLING JOINTS 90° FOR HOSE REELS

## Brass 90° swivelling joint AIR-WATER

Article	Inlet-Outlet	Pressure	Seals
079-1770-003	F3/8"BSP - M3/8"BSP	20 bar	Viton®
079-1770-004	F1/2"BSP - M1/2"BSP	100 bar	Viton®
079-1770-006	F1"BSP - M3/4"BSP	50 bar	Viton®



079-1770-003

079-1770-004

## Anodized aluminium 90° swivelling joint AIR-WATER

Article	Inlet-Outlet	Pressure	Seals
079-1770-808	F1.1/2"BSP - M1.1/2"BSP	20 bar	Viton®
079-1770-909	F2"BSP - M54x1,5"	20 bar	Viton®



079-1770-808

079-1770-909

## AISI 304 stainless steel 90° swivelling joint WATER 150°C

Article	Inlet-Outlet	Pressure	Seals
079-1771-003	F3/8"BSP - M3/8"BSP	280 bar	Viton®
079-1771-004	F1/2"BSP - M1/2"BSP	400 bar	Viton®
079-1771-006	F1"BSP - M3/4"BSP	200 bar	Viton®



079-1771-004

079-1771-006

## AISI 304 stainless steel 90° swivelling joint FOOD 120°C

Article	Inlet-Outlet	Pressure	Seals
079-1771-404	F1/2"BSP - M1/2"BSP	200 bar	EPDM - FDA
079-1771-506	F1"BSP - M3/4"BSP	100 bar	EPDM - FDA



079-1771-404

079-1771-506

## Galvanized steel 90° swivelling joint OIL AND SIMILAR

Article	Inlet-Outlet	Pressure	Seals
079-1772-004	F1/2"BSP - M1/2"BSP	200 bar	NBR
079-1772-006	F1"BSP - M3/4"BSP	100 bar	NBR
079-1772-606	F1"BSP - M1"BSP	100/300 bar	NBR
079-1772-808	F1.1/2"BSP - M1.1/2"BSP	100/300 bar	NBR
079-1772-909	F2"BSP - M54x1,5"	80/250 bar	NBR



079-1772-004

079-1772-808

## Galvanized steel 90° swivelling joint GREASE

Article	Inlet-Outlet	Pressure	Seals
079-1773-002	M1/4"BSP - M3/8"BSP	600 bar	polyurethane
079-1773-003	M3/8"BSP - M3/8"BSP	500 bar	polyurethane
079-1773-004	M1/2"BSP - M1/2"BSP	400 bar	NBR
079-1773-006	M1"BSP - M1"BSP	300 bar	NBR



079-1773-002

079-1773-004

## Galvanized steel - anodized aluminium 90° swivelling joint DIESEL

Article	Inlet-Outlet	Pressure	Seals
079-1774-526	F1"BSP - F3/4"BSP	50 bar	Viton®
079-1774-006	F1"BSP - M3/4"BSP	50 bar	Viton®

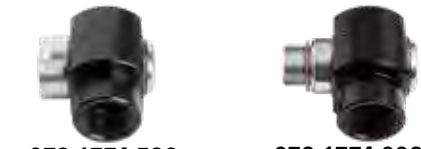

079-1774-526

079-1774-006

## Galvanized steel 90° swivelling joint GASOLINE

Article	Inlet-Outlet	Pressure	Seals
079-1774-V06	F1"BSP - M3/4"BSP	100 bar	Viton®



079-1774-V06

# GALVANIZED STEEL CONNECTION FITTINGS

## BSP male - BSP male nipples



Article	Threaded
F96-0100-202	M1/4" BSP - M1/4" BSP
F96-0100-303	M3/8" BSP - M3/8" BSP
F96-0100-404	M1/2" BSP - M1/2" BSP
F96-0100-505	M3/4" BSP - M3/4" BSP
F96-0100-606	M1" BSP - M1" BSP
F96-0100-707	M1.1/4" BSP - M1.1/4" BSP
F96-0100-808	M1.1/2" BSP - M1.1/2" BSP
F96-0100-909	M2" BSP - M2" BSP

## BSP male - BSP male reduced nipples



Article	Threaded
F96-0100-302	M3/8" BSP - M1/4" BSP
F96-0100-402	M1/2" BSP - M1/4" BSP
F96-0100-403	M1/2" BSP - M3/8" BSP
F96-0100-504	M3/4" BSP - M1/2" BSP
F96-0100-604	M1" BSP - M1/2" BSP
F96-0100-605	M1" BSP - M3/4" BSP
F96-0100-706	M1.1/4" BSP - M1" BSP
F96-0100-806	M1.1/2" BSP - M1" BSP
F96-0100-807	M1.1/2" BSP - M1.1/4" BSP
F96-0100-907	M2" BSP - M1.1/4" BSP
F96-0100-908	M2" BSP - M1.1/2" BSP

## BSP male - BSP female extensions



Article	Threaded
F96-0210-404	M1/2" BSP - F1/2" BSP
F96-0210-505	M3/4" BSP - F3/4" BSP

## BSP male - BSP female reduced extensions



Article	Threaded
F96-0210-203	M1/4" BSP - F3/8" BSP
F96-0210-304	M3/8" BSP - F1/2" BSP
F96-0210-305	M3/8" BSP - F3/4" BSP
F96-0210-405	M1/2" BSP - F3/4" BSP
F96-0210-506	M3/4" BSP - F1" BSP

## BSP male - BSP female plug reductions



Article	Threaded
F96-0300-201	M1/4" BSP - F1/8" BSP
F96-0300-302	M3/8" BSP - F1/4" BSP
F96-0300-403	M1/2" BSP - F3/8" BSP
F96-0300-504	M3/4" BSP - F1/2" BSP
F96-0300-604	M1" BSP - F1/2" BSP
F96-0300-605	M1" BSP - F3/4" BSP
F96-0300-908	M2" BSP - F1.1/2" BSP



## Galvanized steel connection ring nut

F96-0050-322	M3/8" G - F22X1,5	250 bar	40 l/min
--------------	-------------------	---------	----------

Suitable for connecting pressure washer spray guns

## BSP male - NPTF male nipples



Article	Threaded
F96-0110-202	M1/4" BSP - M1/4" NPTF
F96-0110-303	M3/8" BSP - M3/8" NPTF
F96-0110-404	M1/2" BSP - M1/2" NPTF
F96-0110-505	M3/4" BSP - M3/4" NPTF
F96-0110-606	M1" BSP - M1" NPTF
F96-0110-707	M1.1/4" BSP - M1.1/4" NPTF
F96-0110-808	M1.1/2" BSP - M1.1/2" NPTF
F96-0110-909	M2" BSP - M2" NPTF
F96-0111-404	M1/2" BSP - M1/2" NPTF E.22

## BSP male - NPTF male reduced nipples



Article	Threaded
F96-0110-204	M1/4" BSP - M1/2" NPTF
F96-0110-302	M3/8" BSP - M1/4" NPTF
F96-0110-304	M3/8" BSP - M1/2" NPTF
F96-0110-305	M3/8" BSP - M3/4" NPTF
F96-0110-402	M1/2" BSP - M1/4" NPTF
F96-0110-403	M1/2" BSP - M3/8" NPTF
F96-0110-405	M1/2" BSP - M3/4" NPTF
F96-0110-504	M3/4" BSP - M1/2" NPTF
F96-0110-604	M1" BSP - M1/2" NPTF
F96-0110-605	M1" BSP - M3/4" NPTF
F96-0110-806	M1.1/2" BSP - M1" NPTF
F96-0110-807	M1.1/2" BSP - M1.1/4" NPTF
F96-0110-907	M2" BSP - M1.1/4" NPTF
F96-0110-908	M2" BSP - M1.1/2" NPTF
F96-0111-204	M1/4" BSP - M1/2" NPTF E.22
F96-0111-304	M3/8" BSP - M1/2" NPTF E.22

## NPTF male - BSP female extensions



Article	Threaded
F96-0212-404	M1/2" NPTF - F1/2" BSP
F96-0212-505	M3/4" NPTF - F3/4" BSP

## NPTF male - BSP female reduced extensions



Article	Threaded
F96-0212-304	M3/8" NPTF - F1/2" BSP
F96-0212-305	M3/8" NPTF - F3/4" BSP
F96-0212-405	M1/2" NPTF - F3/4" BSP
F96-0212-506	M3/4" NPTF - F1" BSP

## NPTF male - BSP female plug reductions



Article	Threaded
F96-0302-403	M1/2" NPTF - F3/8" BSP
F96-0302-504	M3/4" NPTF - F1/2" BSP
F96-0302-605	M1" NPTF - F3/4" BSP

# AISI 316 STAINLESS STEEL CONNECTION FITTINGS

## AISI 316 stainless steel BSP male - BSP male nipples

Article	Threaded
F96-1100-202	M1/4" BSP - M1/4" BSP
F96-1100-303	M3/8" BSP - M3/8" BSP
F96-1100-404	M1/2" BSP - M1/2" BSP
F96-1100-505	M3/4" BSP - M3/4" BSP
F96-1100-606	M1" BSP - M1" BSP



## AISI 316 stainless steel BSP male - NPTF male nipples

Article	Threaded
F96-1110-303	M3/8" BSP - M3/8" NPTF
F96-1110-404	M1/2" BSP - M1/2" NPTF
F96-1110-505	M3/4" BSP - M3/4" NPTF
F96-1110-606	M1" BSP - M1" NPTF
F96-1111-404	M1/2" BSP - M1/2" NPTF E.22



## AISI 316 stainless steel BSP male - BSP male reduced nipples

Article	Threaded
F96-1100-302	M3/8" BSP - M1/4" BSP
F96-1100-403	M1/2" BSP - M3/8" BSP
F96-1100-504	M3/4" BSP - M1/2" BSP
F96-1100-604	M1" BSP - M1/2" BSP
F96-1100-605	M1" BSP - M3/4" BSP



## AISI 316 stainless steel BSP male - NPTF male reduced nipples

Article	Threaded
F96-1110-204	M1/4" BSP - M1/2" NPTF
F96-1110-304	M3/8" BSP - M1/2" NPTF
F96-1110-305	M3/8" BSP - M3/4" NPTF
F96-1110-403	M1/2" BSP - M3/8" NPTF
F96-1110-405	M1/2" BSP - M3/4" NPTF
F96-1110-504	M3/4" BSP - M1/2" NPTF
F96-1110-604	M1" BSP - M1/2" NPTF
F96-1110-605	M1" BSP - M3/4" NPTF
F96-1111-204	M1/4" BSP - M1/2" NPTF E.22
F96-1111-304	M3/8" BSP - M1/2" NPTF E.22



## AISI 316 stainless steel BSP male - BSP female extension

Article	Threaded
F96-1210-404	M1/2" BSP - F1/2" BSP
F96-1210-505	M3/4" BSP - F3/4" BSP



## AISI 316 stainless steel NPTF male - BSP female extension

Article	Threaded
F96-1212-404	M1/2" NPTF - F1/2" BSP
F96-1212-505	M3/4" NPTF - F3/4" BSP



## AISI 316 stainless steel BSP male - BSP female reduced extension

Article	Threaded
F96-1210-304	M3/8" BSP - F1/2" BSP
F96-1210-305	M3/8" BSP - F3/4" BSP
F96-1210-405	M1/2" BSP - F3/4" BSP



## AISI 316 stainless steel NPTF male - BSP female reduced extension

Article	Threaded
F96-1212-304	M3/8" NPTF - F1/2" BSP
F96-1212-305	M3/8" NPTF - F3/4" BSP
F96-1212-405	M1/2" NPTF - F3/4" BSP



## AISI 316 stainless steel BSP male - BSP female plug reductions

Article	Threaded
F96-1300-403	M1/2" BSP - F3/8" BSP
F96-1300-504	M3/4" BSP - F1/2" BSP
F96-1300-605	M1" BSP - F3/4" BSP



## AISI 316 stainless steel NPTF male - BSP female plug reductions

Article	Threaded
F96-1302-403	M1/2" NPTF - F3/8" BSP
F96-1302-504	M3/4" NPTF - F1/2" BSP
F96-1302-605	M1" NPTF - F3/4" BSP



# RUBBER HOSE-STOP CONNECTION HOSES FOR HOSE REELS - TECHNICAL DATA

## Rubber hose-stop for hose reels



Article	Ø Hose size	Ø External Hose	Ø Hose-stop
079-1780-001	1/4"	12 - 13 mm	80 mm
079-1780-002	5/16"	14 - 15 mm	80 mm
079-1780-003	3/8"	16 - 17 mm	80 mm
079-1780-004	1/2"	19 - 20 mm	80 mm
079-1780-005	3/4"	26 - 27 mm	80 mm
079-1780-006	1"	34 - 35 mm	80 mm

## Rubber hose stop for industrial hose reels



Article	Ø Hose size	Ø External Hose	Ø Hose-stop
079-1782-006	1"	34 - 36 mm	150 mm
079-1782-007	1.1/4"	40 - 43 mm	150 mm
079-1782-008	1.1/2"	47 - 50 mm	150 mm
079-1782-009	2"	60 - 63 mm	150 mm

## AIR-WATER 20 bar

- Blue polyurethane ether-baset hoses
- Connection nickel-plated brass - galvanized steel



Article	L.Hose	Ø Hose-dimension	Max pressure	Inlet - Outlet
901-0302-015	1,5 m	8X12 mm	20 bar	M3/8"G - F1/4"G
901-0302-020	2,0 m	8X12 mm	20 bar	M1/4"G - F1/4"G
901-0323-006	0,6 m	10X14 mm	20 bar	F3/8"-F3/8"BSP
901-0323-015	1,5 m	10X14 mm	20 bar	F3/8"-F3/8" BSP
901-0303-020	2,0 m	10X14 mm	20 bar	M3/8"-F3/8" BSP
901-0424-006	0,6 m	13X19 mm	20 bar	F1/2"-F1/2" BSP
901-0424-015	1,5 m	13X19 mm	20 bar	F1/2"-F1/2" BSP
901-0404-020	2,0 m	13X19 mm	20 bar	M1/2"-F1/2" BSP

## AIR-WATER from 20 to 28 bar

- Synthetic black rubber hoses R6
- Galvanized steel connections



Article	L.hose	Ø Hose-dimension	Max pressure	Inlet - Outlet
902-0222-010	1,0 m	5/16" - 7,9X14 mm	28 bar	F3/8"-F3/8" BSP
902-0222-020	2,0 m	5/16" - 7,9X14 mm	28 bar	F3/8"-F3/8" BSP
902-0323-006	0,6 m	3/8" - 9,5X15,8 mm	28 bar	F3/8"-F3/8" BSP
902-0323-010	1,0 m	3/8" - 9,5X15,8 mm	28 bar	F3/8"-F3/8" BSP
902-0323-015	1,5 m	3/8" - 9,5X15,8 mm	28 bar	F3/8"-F3/8" BSP
902-0323-020	2,0 m	3/8" - 9,5X15,8 mm	28 bar	F3/8"-F3/8" BSP
902-0424-006	0,6 m	1/2" - 12,8X19,4 mm	28 bar	F1/2"-F1/2" BSP
902-0424-010	1,0 m	1/2" - 12,8X19,4 mm	28 bar	F1/2"-F1/2" BSP
902-0424-015	1,5 m	1/2" - 12,8X19,4 mm	28 bar	F1/2"-F1/2" BSP
902-0424-020	2,0 m	1/2" - 12,8X19,4 mm	28 bar	F1/2"-F1/2" BSP
902-0525-006	0,6 m	3/4" - 19X26 mm	21 bar	F3/4"-F3/4" BSP
902-0525-010	1,0 m	3/4" - 19X26 mm	21 bar	F3/4"-F3/4" BSP
902-0525-015	1,5 m	3/4" - 19X26 mm	21 bar	F3/4"-F3/4" BSP
902-0525-020	2,0 m	3/4" - 19X26 mm	21 bar	F3/4"-F3/4" BSP
902-0626-006	0,6 m	1" - 25,4X33 mm	20 bar	F1"-F1" BSP
902-0626-010	1,0 m	1" - 25,4X33 mm	20 bar	F1"-F1" BSP
902-0626-015	1,5 m	1" - 25,4X33 mm	20 bar	F1"-F1" BSP
902-0626-020	2,0 m	1" - 25,4X33 mm	20 bar	F1"-F1" BSP

# CONNECTION HOSES FOR HOSE REELS

## TECHNICAL DATA

### WATER 150 °C 200 bar

- Blue no trace synthetic rubber hoses 1SC
- Galvanized steel connections

Article	L.hose	Ø Hose-dimension	Max pressure	Inlet - Outlet
904-0323-006	0,6 m	3/8" - 9,5X15,6 mm	200 bar	F3/8"-F3/8" BSP
904-0323-015	1,5 m	3/8" - 9,5X15,6 mm	200 bar	F3/8"-F3/8" BSP
904-0424-006	0,6 m	1/2" - 12,8X19,1 mm	200 bar	F1/2"-F1/2" BSP
904-0424-015	1,5 m	1/2" - 12,8X19,1 mm	200 bar	F1/2"-F1/2" BSP



### WATER 150 °C 400 bar

- Blue no trace synthetic rubber hoses 2SC
- Galvanized steel connections

Article	L.hose	Ø Hose-dimension	Max pressure	Inlet - Outlet
905-0323-006	0,6 m	3/8" - 9,5X17,0 mm	400 bar	F3/8"-F3/8" BSP
905-0323-015	1,5 m	3/8" - 9,5X17,0 mm	400 bar	F3/8"-F3/8" BSP
905-0424-006	0,6 m	1/2" - 12,8X20,4 mm	400 bar	F1/2"-F1/2" BSP
905-0424-015	1,5 m	1/2" - 12,8X20,4 mm	400 bar	F1/2"-F1/2" BSP



### OIL AND SIMILAR FLUIDS from 88 to 160 bar

- Black synthetic rubber hoses 1SC
- Galvanized steel connections

Article	L.hose	Ø Hose-dimension	Max pressure	Inlet - Outlet
906-0424-006	0,6 m	1/2" - 12,8X19,1 mm	160 bar	F1/2"-F1/2" BSP
906-0434-008	0,8 m	1/2" - 12,8X19,1 mm	160 bar	F90° 1/2"-F1/2" BSP
906-0424-010	1,0 m	1/2" - 12,8X19,1 mm	160 bar	F1/2"-F1/2" BSP
906-0424-015	1,5 m	1/2" - 12,8X19,1 mm	160 bar	F1/2"-F1/2" BSP
906-0424-020	2,0 m	1/2" - 12,8X19,1 mm	160 bar	F1/2"-F1/2" BSP
906-0525-006	0,6 m	3/4" - 19X26 mm	105 bar	F3/4"-F3/4" BSP
906-0535-008	0,8 m	3/4" - 19X26 mm	105 bar	F90° 3/4"-F3/4" BSP
906-0525-010	1,0 m	3/4" - 19X26 mm	105 bar	F3/4"-F3/4" BSP
906-0525-015	1,5 m	3/4" - 19X26 mm	105 bar	F3/4"-F3/4" BSP
906-0525-020	2,0 m	3/4" - 19X26 mm	105 bar	F3/4"-F3/4" BSP
906-0626-006	0,6 m	1" - 25,4X33,4 mm	88 bar	F1"-F1" BSP
906-0636-008	0,8 m	1" - 25,4X33,4 mm	88 bar	F90° 1"-F1" BSP
906-0626-010	1,0 m	1" - 25,4X33,4 mm	88 bar	F1"-F1" BSP
906-0626-015	1,5 m	1" - 25,4X33,4 mm	88 bar	F1"-F1" BSP
906-0626-020	2,0 m	1" - 25,4X33,4 mm	88 bar	F1"-F1" BSP



### GREASE from 275 to 400 bar

- Black synthetic rubber hoses 2SC
- Galvanized steel connections

Article	L.hose	Ø Hose-dimension	Max pressure	Inlet - Outlet
907-0122-006	0,6 m	1/4" - 6,4X13,3 mm	400 bar	F1/4"-F1/4" BSP
907-0132-008	0,8 m	1/4" - 6,4X13,3 mm	400 bar	F90° 1/4"-F1/4" BSP
907-0122-015	1,5 m	1/4" - 6,4X13,3 mm	400 bar	F1/4"-F1/4" BSP
907-0102-015	1,5 m	1/4" - 6,4X13,3 mm	400 bar	M1/4"-F1/4" BSP
907-0122-020	2,0 m	1/4" - 6,4X13,3 mm	400 bar	F1/4"-F1/4" BSP
907-0323-006	0,6 m	3/8" - 9,5X17 mm	330 bar	F3/8"-F3/8" BSP
907-0333-008	0,8 m	3/8" - 9,5X17 mm	330 bar	F90° 3/8"-F3/8" BSP
907-0323-015	1,5 m	3/8" - 9,5X17 mm	330 bar	F3/8"-F3/8" BSP
907-0323-020	2,0 m	3/8" - 9,5X17 mm	330 bar	F3/8"-F3/8" BSP
907-0424-006	0,6 m	1/2" - 12,8X20,4 mm	275 bar	F1/2"-F1/2" BSP
907-0434-008	0,8 m	1/2" - 12,8X20,4 mm	275 bar	F90° 1/2"-F1/2" BSP
907-0424-015	1,5 m	1/2" - 12,8X20,4 mm	275 bar	F1/2"-F1/2" BSP
907-0424-020	2,0 m	1/2" - 12,8X20,4 mm	275 bar	F1/2"-F1/2" BSP



# CONNECTION HOSES FOR HOSE REELS

## TECHNICAL DATA

### GREASE from 165 to 215 bar

- Black synthetic rubber hoses 2SC
- Galvanized steel connections



Article	L.hose	Ø Hose-dimension	Max pressure	Inlet - Outlet
907-0525-006	0,6 m	3/4" - 19X27,5 mm	215 bar	F3/4"-F3/4" BSP
907-0535-008	0,8 m	3/4" - 19X27,5 mm	215 bar	F90° 3/4"-F3/4" BSP
907-0525-015	1,5 m	3/4" - 19X27,5 mm	215 bar	F3/4"-F3/4" BSP
907-0626-006	0,6 m	1" - 25,4X35,3 mm	165 bar	F1"-F1" BSP
907-0636-008	0,8 m	1" - 25,4X35,3 mm	165 bar	F90° 1"-F1" BSP
907-0626-015	1,5 m	1" - 25,4X35,3 mm	165 bar	F1"-F1" BSP

### DIESEL 10 bar

- Black antistatic synthetic rubber hoses
- Galvanized steel connections



Article	L.hose	Ø Hose-dimension	Max pressure	Inlet - Outlet
908-0516-020	2,0 m	3/4" - 19X27 mm	10 bar	M1"-M1" BSP
908-0616-020	2,0 m	1" - 25X35 mm	10 bar	M1"-M1" BSP

### GASOLINE 16 bar

- Black antistatic synthetic rubber hoses steel wire helix with high strength synthetic textile plies, copper wire
- Reference regulations: EN 1761 - EN 12115 ATEX (EX ZONE)
- Self-extinguishing according to: TRbf 131/2
- Galvanized steel connections



Article	L.hose	Ø Hose-dimension	Max pressure	Inlet - Outlet
918-0526-006	0,6 m	3/4" - 19X27 mm	16 bar	F1"-F1" BSP
918-0526-015	1,5 m	3/4" - 19X27 mm	16 bar	F1"-F1" BSP
918-0626-006	0,6 m	1" - 25X35 mm	16 bar	F1"-F1" BSP
918-0626-015	1,5 m	1" - 25X35 mm	16 bar	F1"-F1" BSP

### ANTIFREEZE - WINDSCREEN - AdBlue® 20 bar

- Black antistatic synthetic rubber EPDM hoses
- AISI 316 stainless steel connections



Article	L.hose	Ø Hose-dimension	Max pressure	Inlet - Outlet
909-0424-006	0,6 m	1/2" - 12,8X22 mm	20 bar	F1/2"-F1/2" BSP
909-0424-010	1,0 m	1/2" - 12,8X22 mm	20 bar	F1/2"-F1/2" BSP
909-0424-015	1,5 m	1/2" - 12,8X22 mm	20 bar	F1/2"-F1/2" BSP
909-0424-020	2,0 m	1/2" - 12,8X22 mm	20 bar	F1/2"-F1/2" BSP
909-0525-006	0,6 m	3/4" - 19X29 mm	20 bar	F3/4"-F3/4" BSP
909-0525-010	1,0 m	3/4" - 19X29 mm	20 bar	F3/4"-F3/4" BSP
909-0525-015	1,5 m	3/4" - 19X29 mm	20 bar	F3/4"-F3/4" BSP

### FOOD 120° C 15 bar

- White EPDM rubber tubes with blue cover
- Regulations: DM 21/3/73 e 18/6/79 + FOOD QUALITY F.D.A.
- AISI 316 stainless steel connections



Article	L.hose	Ø Hose-dimension	Max pressure	Inlet - Outlet
913-0424-006	0,6 m	1/2" - 12,8X22 mm	15 bar	F1/2"-F1/2" BSP
913-0424-015	1,5 m	1/2" - 12,8X22 mm	15 bar	F1/2"-F1/2" BSP
913-0525-006	0,6 m	3/4" - 19X29 mm	15 bar	F3/4"-F3/4" BSP
913-0525-015	1,5 m	3/4" - 19X29 mm	15 bar	F3/4"-F3/4" BSP

# HOSES FOR HOSE REELS - TECHNICAL DATA

## AIR-WATER 20 bar

- Blue polyurethane ether-baset hoses
- Connection nickel-plated brass - galvanized steel

Article	L.hose	Ø Hose-dimension	Max pressure	Inlet - Outlet
901-0102-120	12 m	1/4" - 6X10 mm	20 bar	F1/4"G - M1/4"G
901-0202-090	9 m	5/16" - 8X12 mm	20 bar	F1/4"G - M1/4"G
901-0212-110	11 m	5/16" - 8X12 mm	20 bar	M3/8"G - M1/4"G gjr.
901-0202-120	12 m	5/16" - 8X12 mm	20 bar	F3/8"G - M1/4"G gjr.
901-0202-150	15 m	5/16" - 8X12 mm	20 bar	F1/4"G - M1/4"G
901-0202-200	20 m	5/16" - 8X12 mm	20 bar	F3/8"G - M1/4"G gjr.
901-0303-100	10 m	3/8" - 10X14 mm	20 bar	F3/8"-M3/8" BSP
901-0303-150	15 m	3/8" - 10X14 mm	20 bar	F3/8"-M3/8" BSP
901-0303-200	20 m	3/8" - 10X14 mm	20 bar	F3/8"-M3/8" BSP
901-0404-100	10 m	1/2" - 13X19 mm	20 bar	F1/2"-M1/2" BSP
901-0404-150	15 m	1/2" - 13X19 mm	20 bar	F1/2"-M1/2" BSP
901-0404-180	18 m	1/2" - 13X19 mm	20 bar	F1/2"-M1/2" BSP
901-0404-200	20 m	1/2" - 13X19 mm	20 bar	F1/2"-M1/2" BSP
901-0404-250	25 m	1/2" - 13X19 mm	20 bar	F1/2"-M1/2" BSP



## AIR-WATER from 20 to 28 bar

- Synthetic black rubber hoses R6 - FROM 5/16" TO 1"- AERTUB/20 1.1/4" < 2"
- Galvanized steel connections

Article	L.hose	Ø Hose-dimension	Max pressure	Inlet - Outlet
902-0203-120	12 m	5/16" - 7,9X14,3 mm	28 bar	F3/8"-M1/4" BSP
902-0203-180	18 m	5/16" - 7,9X14,3 mm	28 bar	F3/8"-M1/4" BSP
902-0303-100	10 m	3/8"- 9,5X16 mm	28 bar	F3/8"-M3/8" BSP
902-0303-150	15 m	3/8"- 9,5X16 mm	28 bar	F3/8"-M3/8" BSP
902-0303-180	18 m	3/8"- 9,5X16 mm	28 bar	F3/8"-M3/8" BSP
902-0303-200	20 m	3/8"- 9,5X16 mm	28 bar	F3/8"-M3/8" BSP
902-0404-100	10 m	1/2" - 12,7X19 mm	28 bar	F1/2"-M1/2" BSP
902-0404-150	15 m	1/2" - 12,7X19 mm	28 bar	F1/2"-M1/2" BSP
902-0404-180	18 m	1/2" - 12,7X19 mm	28 bar	F1/2"-M1/2" BSP
902-0404-200	20 m	1/2" - 12,7X19 mm	28 bar	F1/2"-M1/2" BSP
902-0404-250	25 m	1/2" - 12,7X19 mm	28 bar	F1/2"-M1/2" BSP
902-0404-300	30 m	1/2" - 12,7X19 mm	28 bar	F1/2"-M1/2" BSP
902-0404-400	40 m	1/2" - 12,7X19 mm	28 bar	F1/2"-M1/2" BSP
902-0404-500	50 m	1/2" - 12,7X19 mm	28 bar	F1/2"-M1/2" BSP
902-0505-150	15 m	3/4"- 19X25,8 mm	21 bar	F3/4"-M3/4" BSP
902-0505-200	20 m	3/4"- 19X25,8 mm	21 bar	F3/4"-M3/4" BSP
902-0505-300	30 m	3/4"- 19X25,8 mm	21 bar	F3/4"-M3/4" BSP
902-0505-400	40 m	3/4"- 19X25,8 mm	21 bar	F3/4"-M3/4" BSP
902-0606-150	15 m	1"- 25,4X33,2 mm	20 bar	F1"-M1" BSP
902-0606-200	20 m	1"- 25,4X33,2 mm	20 bar	F1"G-M1" BSP
902-0606-300	30 m	1"- 25,4X33,2 mm	20 bar	F1"-M1" BSP
902-0708-150	15 m	1.1/4"- 32X44 mm	20 bar	F1.1/2"-M1.1/2" BSP
902-0708-200	20 m	1.1/4"- 32X44 mm	20 bar	F1.1/2"-M1.1/2" BSP
902-0708-300	30 m	1.1/4"- 32X44 mm	20 bar	F1.1/2"-M1.1/2" BSP



# HOSES FOR HOSE REELS - TECHNICAL DATA

## AIR-WATER from 20 bar

- Synthetic black rubber hoses - AERTUB/20
- Galvanized steel connections



Article	L.hose	Ø Hose-dimension	Max pressure	Inlet - Outlet
902-0808-150	15 m	1.1/2"- 38X51 mm	20 bar	F1.1/2"-M1.1/2"BSP
902-0808-200	20 m	1.1/2"- 38X51 mm	20 bar	F1.1/2"-M1.1/2" BSP
902-0808-300	30 m	1.1/2"- 38X51 mm	20 bar	F1.1/2"-M1.1/2" BSP
902-0909-150	15 m	2"- 51X66 mm	20 bar	F2"-M2"BSP
902-0909-200	20 m	2"- 51X66 mm	20 bar	F2"-M2" BSP
902-0909-300	30 m	2"- 51X66 mm	20 bar	F2"-M2" BSP

## WATER 150 °C 200 bar

- Blue no trace synthetic rubber hoses 1SC
- Galvanized steel connections
- Rubber blue handle



Article	L.hose	Ø Hose-dimension	Max pressure	Inlet - Outlet
904-0223-100	10 m	5/16"- 7,9X13,5 mm	200 bar	F3/8"-F3/8" BSP
904-0223-150	15 m	5/16"- 7,9X13,5 mm	200 bar	F3/8"-F3/8" BSP
904-0223-200	20 m	5/16"- 7,9X13,5 mm	200 bar	F3/8"-F3/8" BSP
904-0323-100	10 m	3/8"- 9,5X15,6 mm	200 bar	F3/8"-F3/8" BSP
904-0323-150	15 m	3/8"- 9,5X15,6 mm	200 bar	F3/8"-F3/8" BSP
904-0323-180	18 m	3/8"- 9,5X15,6 mm	200 bar	F3/8"-F3/8" BSP
904-0323-200	20 m	3/8"- 9,5X15,6 mm	200 bar	F3/8"-F3/8" BSP
904-0323-250	25 m	3/8"- 9,5X15,6 mm	200 bar	F3/8"-F3/8" BSP
904-0323-300	30 m	3/8"- 9,5X15,6 mm	200 bar	F3/8"-F3/8" BSP
904-0323-400	40 m	3/8"- 9,5X15,6 mm	200 bar	F3/8"-F3/8" BSP
904-0323-500	50 m	3/8"- 9,5X15,6 mm	200 bar	F3/8"-F3/8" BSP
904-0424-100	10 m	1/2"- 12,8X19,1 mm	200 bar	F1/2"-F1/2" BSP
904-0424-150	15 m	1/2"- 12,8X19,1 mm	200 bar	F1/2"-F1/2" BSP
904-0424-200	20 m	1/2"- 12,8X19,1 mm	200 bar	F1/2"-F1/2" BSP
904-0424-250	25 m	1/2"- 12,8X19,1 mm	200 bar	F1/2"-F1/2" BSP
904-0424-300	30 m	1/2"- 12,8X19,1 mm	200 bar	F1/2"-F1/2" BSP
904-0424-400	40 m	1/2"- 12,8X19,1 mm	200 bar	F1/2"-F1/2" BSP

## WATER 150 °C 400 bar

- Blue no trace synthetic rubber hoses 2SC
- Galvanized steel connections
- Rubber blue handle



Article	L.hose	Ø Hose-dimension	Max pressure	Inlet - Outlet
905-0223-100	10 m	5/16"- 7,9X15 mm	400 bar	F3/8"-F3/8" BSP
905-0223-150	15 m	5/16"- 7,9X15 mm	400 bar	F3/8"-F3/8" BSP
905-0223-200	20 m	5/16"- 7,9X15 mm	400 bar	F3/8"-F3/8" BSP
905-0323-100	10 m	3/8"- 9,5X17 mm	400 bar	F3/8"-F3/8" BSP
905-0323-150	15 m	3/8"- 9,5X17 mm	400 bar	F3/8"-F3/8" BSP
905-0323-180	18 m	3/8"- 9,5X17 mm	400 bar	F3/8"-F3/8" BSP
905-0323-200	20 m	3/8"- 9,5X17 mm	400 bar	F3/8"-F3/8" BSP
905-0323-250	25 m	3/8"- 9,5X17 mm	400 bar	F3/8"-F3/8" BSP
905-0323-300	30 m	3/8"- 9,5X17 mm	400 bar	F3/8"-F3/8" BSP
905-0323-400	40 m	3/8"- 9,5X17 mm	400 bar	F3/8"-F3/8" BSP
905-0323-500	50 m	3/8"- 9,5X17 mm	400 bar	F3/8"-F3/8" BSP

# HOSES FOR HOSE REELS - TECHNICAL DATA

## WATER 150 °C 400 bar

- Blue no trace synthetic rubber hoses 2SC
- Galvanized steel connections
- Rubber blue handle

Article	L.hose	Ø Hose-dimension	Max pressure	Inlet - Outlet
905-0424-100	10 m	1/2"- 12,8X20,4 mm	400 bar	F1/2"-F1/2" BSP
905-0424-150	15 m	1/2"- 12,8X20,4 mm	400 bar	F1/2"-F1/2" BSP
905-0424-200	20 m	1/2"- 12,8X20,4 mm	400 bar	F1/2"-F1/2" BSP
905-0424-250	25 m	1/2"- 12,8X20,4 mm	400 bar	F1/2"-F1/2" BSP
905-0424-300	30 m	1/2"- 12,8X20,4 mm	400 bar	F1/2"-F1/2" BSP
905-0424-400	40 m	1/2"- 12,8X20,4 mm	400 bar	F1/2"-F1/2" BSP



## OIL AND SIMILAR from 40 to 180 bar

- Black synthetic rubber hoses 1SC
- Galvanized steel connections

Article	L.hose	Ø Hose-dimension	Max pressure	Inlet - Outlet
906-0304-100	10 m	3/8"- 9,5X15,6 mm	180 bar	F1/2"-M1/2" BSP
906-0304-150	15 m	3/8"- 9,5X15,6 mm	180 bar	F1/2"-M1/2" BSP
906-0304-180	18 m	3/8"- 9,5X15,6 mm	180 bar	F1/2"-M1/2" BSP
906-0404-100	10 m	1/2"- 12,8X19,1 mm	160 bar	F1/2"-M1/2" BSP
906-0404-150	15 m	1/2"- 12,8X19,1 mm	160 bar	F1/2"-M1/2" BSP
906-0404-180	18 m	1/2"- 12,8X19,1 mm	160 bar	F1/2"-M1/2" BSP
906-0404-200	20 m	1/2"- 12,8X19,1 mm	160 bar	F1/2"-M1/2" BSP
906-0404-250	25 m	1/2"- 12,8X19,1 mm	160 bar	F1/2"-M1/2" BSP
906-0404-300	30 m	1/2"- 12,8X19,1 mm	160 bar	F1/2"-M1/2" BSP
906-0404-400	40 m	1/2"- 12,8X19,1 mm	160 bar	F1/2"-M1/2" BSP
906-0404-500	50 m	1/2"- 12,8X19,1 mm	160 bar	F1/2"-M1/2" BSP
906-0505-150	15 m	3/4"- 19X26 mm	105 bar	F3/4"-M3/4" BSP
906-0505-200	20 m	3/4"- 19X26 mm	105 bar	F3/4"-M3/4" BSP
906-0505-250	25 m	3/4"- 19X26 mm	105 bar	F3/4"-M3/4" BSP
906-0505-300	30 m	3/4"- 19X26 mm	105 bar	F3/4"-M3/4" BSP
906-0505-400	40 m	3/4"- 19X26 mm	105 bar	F3/4"-M3/4" BSP
906-0606-150	15 m	1"- 25,4X33,4 mm	88 bar	F1"-M1" BSP
906-0606-200	20 m	1"- 25,4X33,4 mm	88 bar	F1"-M1" BSP
906-0606-300	30 m	1"- 25,4X33,4 mm	88 bar	F1"-M1" BSP
906-0708-150	15 m	1.1/4"- 31,8X41 mm	63 bar	F1.1/2"-M1.1/2" BSP
906-0708-200	20 m	1.1/4"- 31,8X41 mm	63 bar	F1.1/2"-M1.1/2" BSP
906-0708-300	30 m	1.1/4"- 31,8X41 mm	63 bar	F1.1/2"-M1.1/2" BSP
906-0808-150	15 m	1.1/2"- 38X47,5 mm	50 bar	F1.1/2"-M1.1/2" BSP
906-0808-200	20 m	1.1/2"- 38X47,5 mm	50 bar	F1.1/2"-M1.1/2" BSP
906-0808-300	30 m	1.1/2"- 38X47,5 mm	50 bar	F1.1/2"-M1.1/2" BSP
906-0909-150	15 m	2"- 50,8X60,5 mm	40 bar	F2"-M2" BSP
906-0909-200	20 m	2"- 50,8X60,5 mm	40 bar	F2"-M2" BSP
906-0909-300	30 m	2"- 50,8X60,5 mm	40 bar	F2"-M2" BSP



## HOSES FOR HOSE REELS - TECHNICAL DATA

### GREASE from 165 to 400 bar

- Black synthetic rubber hoses 2SC
- Galvanized steel connections



Article	L.hose	Ø Hose-dimension	Max pressure	Inlet - Outlet
907-0102-100	10 m	1/4"- 6,4X13,3 mm	400 bar	F1/4"-M1/4" BSP
907-0102-150	15 m	1/4"- 6,4X13,3 mm	400 bar	F1/4"-M1/4" BSP
907-0102-180	18 m	1/4"- 6,4X13,3 mm	400 bar	F1/4"-M1/4" BSP
907-0303-100	10 m	3/8"- 9,5X17 mm	330 bar	F3/8"-M3/8" BSP
907-0303-150	15 m	3/8"- 9,5X17 mm	330 bar	F3/8"-M3/8" BSP
907-0303-200	20 m	3/8"- 9,5X17 mm	330 bar	F3/8"-M3/8" BSP
907-0303-250	25 m	3/8"- 9,5X17 mm	330 bar	F3/8"-M3/8" BSP
907-0303-300	30 m	3/8"- 9,5X17 mm	330 bar	F3/8"-M3/8" BSP
907-0404-100	10 m	1/2"- 12,8X20,4 mm	275 bar	F1/2"-M1/2" BSP
907-0404-150	15 m	1/2"- 12,8X20,4 mm	275 bar	F1/2"-M1/2" BSP
907-0404-200	20 m	1/2"- 12,8X20,4 mm	275 bar	F1/2"-M1/2" BSP
907-0404-250	25 m	1/2"- 12,8X20,4 mm	275 bar	F1/2"-M1/2" BSP
907-0404-300	30 m	1/2"- 12,8X20,4 mm	275 bar	F1/2"-M1/2" BSP
907-0505-150	15 m	3/4"- 19X27,5 mm	215 bar	F3/4"-M3/4" BSP
907-0505-200	20 m	3/4"- 19X27,5 mm	215 bar	F3/4"-M3/4" BSP
907-0505-300	30 m	3/4"- 19X27,5 mm	215 bar	F3/4"-M3/4" BSP
907-0606-150	15 m	1"- 25,4X35,3 mm	165 bar	F1"-M1" BSP
907-0606-200	20 m	1"- 25,4X35,3 mm	165 bar	F1"-M1" BSP
907-0606-300	30 m	1"- 25,4X35,3 mm	165 bar	F1"-M1" BSP

### ANTIFREEZE - WINDSCREEN - AdBlue® 20 bar

- Black antistatic synthetic rubber EPDM hoses
- AISI 316 stainless steel connections



Article	L.hose	Ø Hose-dimension	Max pressure	Inlet - Outlet
909-0404-100	10 m	1/2"- 12,8X22 mm	20 bar	F1/2"-M1/2" BSP
909-0404-150	15 m	1/2"- 12,8X22 mm	20 bar	F1/2"-M1/2" BSP
909-0404-200	20 m	1/2"- 12,8X22 mm	20 bar	F1/2"-M1/2" BSP
909-0404-250	25 m	1/2"- 12,8X22 mm	20 bar	F1/2"-M1/2" BSP
909-0505-100	10 m	3/4"-19X29 mm	20 bar	F3/4"-M3/4" BSP
909-0505-150	15 m	3/4"-19X29 mm	20 bar	F3/4"-M3/4" BSP
909-0505-200	20 m	3/4"-19X29 mm	20 bar	F3/4"-M3/4" BSP

# HOSES FOR HOSE REELS - TECHNICAL DATA

## DIESEL 10 bar

- Black antistatic syntetic rubber hoses
- Galvanized steel connections

Article	L.hose	Ø Hose-dimension	Max pressure	Inlet - Outlet
908-0506-080	8 m	3/4" - 19X27 mm	10 bar	F3/4"-M1" BSP
908-0506-100	10 m	3/4" - 19X27 mm	10 bar	F1"-M1" BSP
908-0506-150	15 m	3/4" - 19X27 mm	10 bar	F1"-M1" BSP
908-0506-200	20 m	3/4" - 19X27 mm	10 bar	F1"-M1" BSP
908-0506-300	30 m	3/4" - 19X27 mm	10 bar	F1"-M1" BSP
908-0506-400	40 m	3/4" - 19X27 mm	10 bar	F1"-M1" BSP
908-0606-100	10 m	1" - 25X35 mm	10 bar	F1"-M1" BSP
908-0606-150	15 m	1" - 25X35 mm	10 bar	F1"-M1" BSP
908-0606-200	20 m	1" - 25X35 mm	10 bar	F1"-M1" BSP
908-0606-300	30 m	1" - 25X35 mm	10 bar	F1"-M1" BSP
908-0808-150	15 m	1.1/2" - 38X49 mm	10 bar	F1.1/2"-M1.1/2" BSP



## GASOLINE 16 bar

- Black antistatic synthetic rubber hoses steel wire helix with high strength syntetic textile plies, copper wire
- Reference regulations: EN 1761 - EN 12115 ATEX (EX ZONE)
- Self-extinguishing according to: TRbf 131/2
- Galvanized steel connections

Article	L.hose	Ø Hose-dimension	Max pressure	Inlet - Outlet
918-0506-100	10 m	3/4" - 19X31 mm	16 bar	F1"-M1" BSP
918-0506-150	15 m	3/4" - 19X31 mm	16 bar	F1"-M1" BSP
918-0506-200	20 m	3/4" - 19X31 mm	16 bar	F1"-M1" BSP
918-0506-300	30 m	3/4" - 19X31 mm	16 bar	F1"-M1" BSP
918-0606-100	10 m	1" - 25X37 mm	16 bar	F1"-M1" BSP
918-0606-150	15 m	1" - 25X37 mm	16 bar	F1"-M1" BSP
918-0606-200	20 m	1" - 25X37 mm	16 bar	F1"-M1" BSP
918-0606-300	30 m	1" - 25X37 mm	16 bar	F1"-M1" BSP



## FOOD 120°C 15 bar

- White EPDM rubber hoses with blue cover
- Regulations: DM 21/3/73 e 18/6/79 + FOOD QUALITY F.D.A.
- AISI 316 stainless steel connections

Article	L.hose	Ø Hose-dimension	Max pressure	Inlet - Outlet
913-0404-100	10 m	1/2" - 12,8X22 mm	15 bar	F1/2"-M1/2" BSP
913-0404-150	15 m	1/2" - 12,8X22 mm	15 bar	F1/2"-M1/2" BSP
913-0404-200	20 m	1/2" - 12,8X22 mm	15 bar	F1/2"-M1/2" BSP
913-0404-250	25 m	1/2" - 12,8X22 mm	15 bar	F1/2"-M1/2" BSP
913-0404-300	30 m	1/2" - 12,8X22 mm	15 bar	F1/2"-M1/2" BSP
913-0505-150	15 m	3/4" - 19X29 mm	15 bar	F3/4"-M3/4" BSP
913-0505-200	20 m	3/4" - 19X29 mm	15 bar	F3/4"-M3/4" BSP



# ATEX REGULATION



## Safety in explosive environments

As of 1st July 2003, the ATEX directive came into force throughout the EEC. This directive became an obligatory requirement for all electrical and mechanical equipment intended for use in dangerous areas. Potentially explosive atmospheres exist where there is a risk of explosion due to mixtures of gas and air, steam and air, dust and air or other flammable combinations typical of petrol vapours. If the electrical or mechanical material must be used in areas where there is an explosive atmosphere, it must be designed and built so as not to create/ to eliminate sources of ignition such as sparks, hot surfaces or static electricity and all sources of combustion able to ignite these mixtures. Risk areas for environments where gas and flammable vapours are present can range from AREA 0 (constant risk of explosion) to AREA 1 (risk of explosion probable) and AREA 2 (low risk and any risk of explosion persists for a short time only).

## Atex codification key of Meclube products – “GAS” type of atmosphere

		II	2	G	Ex	h	IIB	$T_4 \leq T 135^{\circ}\text{C}$	Gb	X
1	2	3	4	5	6	7	8	9	10	11

1= CE marking

2= Ex marking (specific explosion protection marking)

3= Group of belonging of the equipment: II = other places, not the mine (gas and dust)

4= High level of protection, presence of possible explosive atmosphere – usable in ZONE 1

5= Type of atmosphere – Gas – usable in ZONE 1

6= Marking for CE regulations (regulation of EN 60079 – DIN EN ISO 80079)

7= General marking, mechanical equipment, not electric

8= Typical ethylene gas

9= Temperature range (Gas), maximum superficial temperature  $\leq 135^{\circ}\text{C}$

10= Protection level of the equipment usable in “Group II” – high protection level.

11= Make reference to the instruction manual for important additional notes – range of ambient temperature.

## Atex codification key of Meclube products – “Dust” type of atmosphere

		II	2	D	Ex	h	III C	$T_4 \leq T 135^{\circ}\text{C}$	Db
1	2	3	4	5	6	7	8	9	10

1= CE marking

2= Ex marking (specific explosion protection marking)

3= Group of belonging of the equipment: II = other places, not the mine (gas and dust)

4= High level of protection, presence of possible explosive atmosphere – usable in ZONE 21

5= Type of atmosphere –Dust – usable in ZONE 21

6= Marking for CE regulations (regulation of EN 60079 – DIN EN ISO 80079)

7= General marking, mechanical equipment, not electric

8= Flammable particles, conductive and non-conductive dust

9= Temperature range (Gas), maximum superficial temperature  $\leq 135^{\circ}\text{C}$

10= Protection level of the equipment usable in “Group III”– high protection level.

# GENERAL SALES CONDITIONS

When ordering please use the part numbers indicated in the catalogue.

Claims will not be accepted if we receive them 8 (eight) days after the reception of the order.

After this period the goods will be considered tacitly accepted.

The goods travel at customer's risk, even if Meclube organizes DAP shipment.

Except previously agreed, all prices are to be intended EX WORKS Bondeno di Gonzaga (MN), Incoterms 2020.

In case of late payments for any reason, including missed reception of statements of account, the buyer has to pay to the seller the annual interest in force at the moment of the sale, in the amount indicated on the invoice.

Any change of faulty products can be made to MECLUBE according to DAP Incoterms, and after having received our authorization.

The company MECLUBE takes no responsibilities for missing goods or damaged parcels caused by the shipment.

For any controversy only the Court of Mantua will entertain jurisdiction.

Specifications, dimensions, features and colours reported in this catalogue are not binding, and due to continuous performance enhancements of equipment and accessories, can be modified without any notice.

EDITION 01/02/2024

Foto F.lli ZAMBRONI

MADE IN ITALY



**MECLUBE srl**

Strada Pavesa, 13 - Loc. Bondeno  
46023- Gonzaga (MN) - ITALIA  
Tel. +39 0376 595006 - +39 0376 595035  
Fax +39 0376 54144  
info@meclube.com

**[www.meclube.com](http://www.meclube.com)**